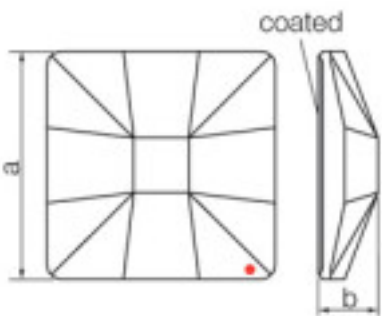

Catálogo **SWAROVSKI CRYSTAL**
 Línea **Strass Swarovski Crystal**
 Familia **Piezas para Pegar Strass Swarovski**

Subfamilia **Cristales Planos Strass Coated En Parte Plana**

NOTA IMPORTANTE: Las líneas STRASS y SPECTRA están fuera de producción. Los artículos en stock estarán disponibles hasta fin de existencias.

Imagen	Artículo	Descripción	Lote	Precio/Unidad
	113783101		1	1,07 €
	Classic Square 2483/10mm Bermbl Swarovski Crystal		48	0,86 €
			144	0,74 €

Coated en parte plana. Medidas: A=10(+/-0,3) ;
B=3,5(+/-0,3)

Longitud (mm): 10 Ancho (mm): 10
Color: Bermuda Blue

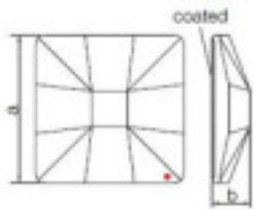

	113783102		1	0,69 €
	Crystal Square 8083 010 001 Blazing Red Swarovski Crystal		245	0,62 €
			980	0,60 €

Coated en parte plana. Medidas: A=10(+/-0,3) ;
B=3,5(+/-0,3)

Longitud (mm): 10 Ancho (mm): 10



SWAROVSKI CRYSTAL > Strass Swarovski Crystal > Piezas para Pegar Strass Swarovski

Subfamilia Cristales Planos Strass Coated En Parte Plana

Imagen	Artículo	Descripción	Lote	Precio/Unidad
	113783103A		1	1,02 €
	Asymmetric Square 2420/10mm CAL V'SI Swarovski Crystal		48	0,82 €
			144	0,70 €

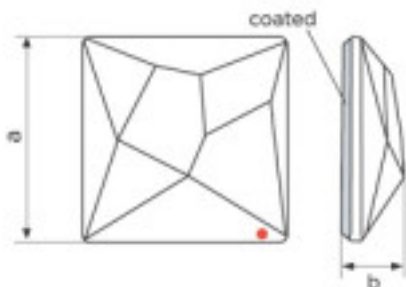

Coated en parte plana. Medidas: A=10mm (+/-0,3mm); B=3,5mm (+/-0,3mm)

Longitud (mm): 10 Ancho (mm): 10

Referencia: 1066793



	113783104		1	1,07 €
	Classic Square 2483/10mm Sahara Swarovski Crystal		48	0,86 €
			144	0,74 €

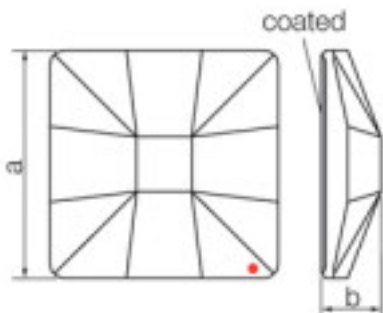

Coated en parte plana. Medidas: A=10mm (+/-0,3mm); B=3,5mm (+/-0,3mm)

Longitud (mm): 10 Ancho (mm): 10



SWAROVSKI CRYSTAL > Strass Swarovski Crystal > Piezas para Pegar Strass Swarovski

Subfamilia Cristales Planos Strass Coated En Parte Plana

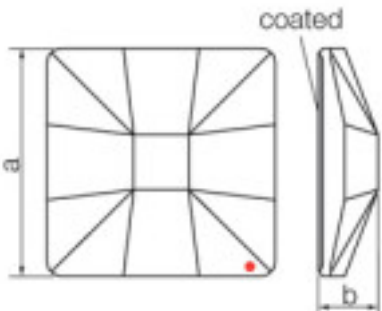
Imagen	Artículo	Descripción	Lote	Precio/Unidad
	113783105		1	1,07 €
	Classic Square 2483/10mm Sage Swarovski Crystal		48	0,86 €
	Coated en parte plana. Medidas: A=10mm (+/-0,3mm); B=3,5mm (+/-0,3mm)		144	0,74 €

Longitud (mm): 10 Ancho (mm): 10

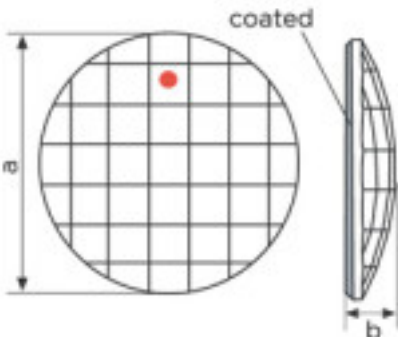

	113783201		1	4,93 €
	Chessboard Circle 2035/20mm Bermbl Swarovski Crystal		20	3,95 €
	Efecto aplicado en parte plana. Medidas: A=20mm (+/-0,3mm); B=3,8mm (+/-0,3mm).		40	3,44 €

Color: Bermuda Blue



SWAROVSKI CRYSTAL > Strass Swarovski Crystal > Piezas para Pegar Strass Swarovski

Subfamilia Cristales Planos Strass Coated En Parte Plana

Imagen	Artículo	Descripción	Lote	Precio/Unidad
	113783204		1	5,53 €
	2035/20mm Sahara		20	4,43 €
			40	3,84 €

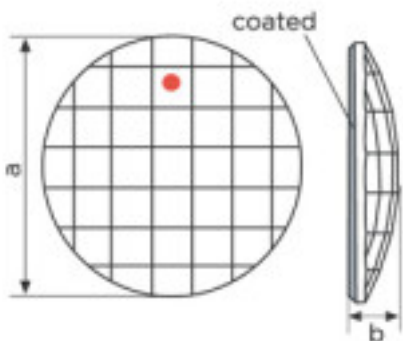

Efecto aplicado en parte plana. Medidas: A=20mm (+/-0,3mm); B=3,8mm (+/-0,3mm).



	113783205		1	5,15 €
	Crystal Circle 8083 020mm 002 Sage Swarovski		72	4,12 €
	Crystal		360	3,58 €

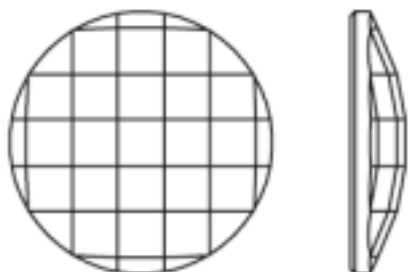

Efecto aplicado en parte plana. Medidas: A=20mm (+/-0,3mm); B=3,8mm (+/-0,3mm).

Longitud (mm): 20



SWAROVSKI CRYSTAL > Strass Swarovski Crystal > Piezas para Pegar Strass Swarovski

Subfamilia Cristales Planos Strass Coated En Parte Plana

Imagen	Artículo	Descripción	Lote	Precio/Unidad
	113783251A		1	8,61 €
	Asymmetric Square 2420/25mm Bermuda blue		16	6,87 €
			32	5,99 €

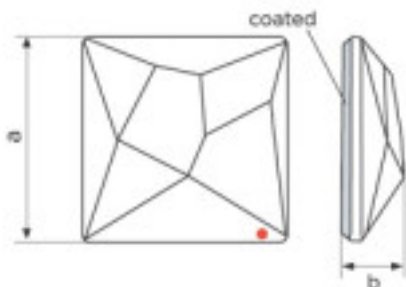

Efecto aplicado en parte plana. Medidas: A=25mm (+/-0,3mm); B=6,5mm (+/-0,3mm)

Color: Bermuda Blue



	113783252		1	2,60 €
	Crystal Square 8083 025 001 Blazing Red Swarovski Crystal		32	2,32 €
			256	2,30 €

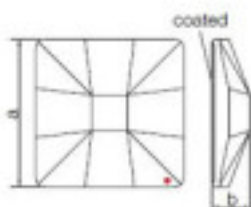

Efecto aplicado en parte plana. Medidas: A=25mm (+/-0,3mm); B=6,5mm (+/-0,3mm)

Longitud (mm): 25 Ancho (mm): 25



SWAROVSKI CRYSTAL > Strass Swarovski Crystal > Piezas para Pegar Strass Swarovski

Subfamilia Cristales Planos Strass Coated En Parte Plana

Imagen	Artículo	Descripción	Lote	Precio/Unidad
	113783253A		1	7,00 €
	Asymmetric Square 2420/25mm CAL V'SI Swarovski Crystal		16	5,60 €
			32	4,87 €

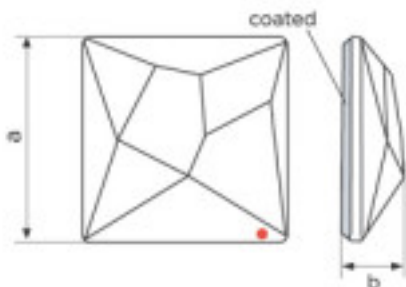

Efecto aplicado en parte plana. Medidas: A=25mm (+/-0,3mm); B=6,5mm (+/-0,3mm)

Referencia: 1066810



	113783254		1	6,18 €
	Classic Square 2483/25mm Sahara Swarovski Crystal		16	4,95 €
			32	4,29 €

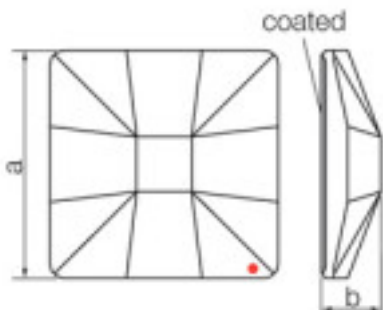

Efecto aplicado en parte plana. Medidas: A=25mm (+/-0,3mm); B=6,5mm (+/-0,3mm)



SWAROVSKI CRYSTAL > Strass Swarovski Crystal > Piezas para Pegar Strass Swarovski

Subfamilia Cristales Planos Strass Coated En Parte Plana

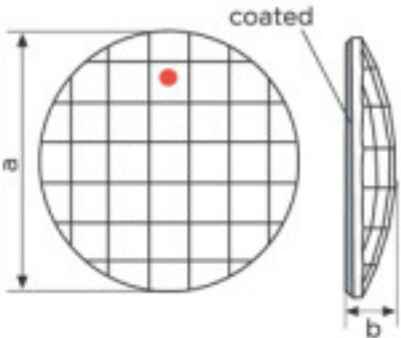
Imagen	Artículo	Descripción	Lote	Precio/Unidad
	113783303		1	10,49 €
	Chessboard Circle 2035/30mm CAL`V`SI Swarovski Crystal		6	8,40 €
			12	7,31 €

Efecto aplicado en parte plana. Medidas: A=30mm (+/-0,3mm); B=6,2mm (+/-0,3mm)

Referencia: 1066835

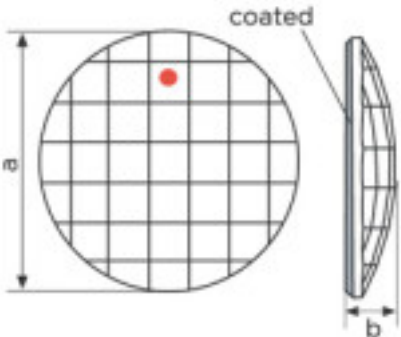

	113783401		1	14,12 €
	Chessboard Circle 2035/40mm Berbml Swarovski Crystal		3	11,30 €
			6	9,82 €

Efecto aplicado en parte plana. Medidas: A=40mm (+/-0,3mm); B=7,7mm (+/-0,3mm)

Color: Bermuda Blue



SWAROVSKI CRYSTAL > Strass Swarovski Crystal > Piezas para Pegar Strass Swarovski

Subfamilia Cristales Planos Strass Coated En Parte Plana

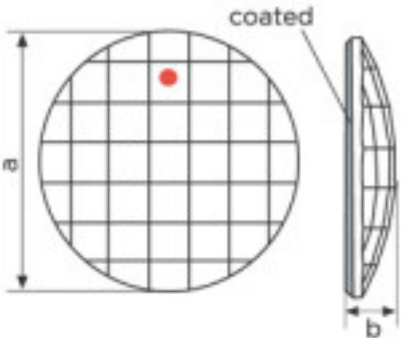
Imagen	Artículo	Descripción	Lote	Precio/Unidad
	113783403		1	21,44 €
	Chessboard Circle 2035/40mm CAL`V`SI Swarovski Crystal		3	17,15 €
			6	14,91 €

Efecto aplicado en parte plana. Medidas: A=40mm (+/-0,3mm); B=7,7mm (+/-0,3mm)

Referencia: 1066846

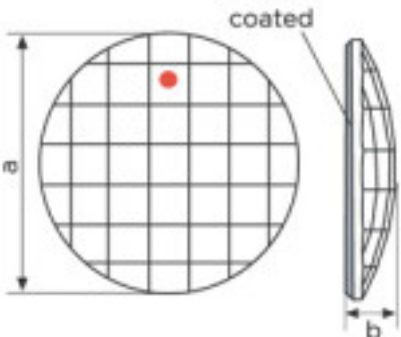

	113783404		1	13,14 €
	Chessboard Circle 2035/40mm Sahara Swarovski Crystal		3	10,51 €
			6	9,15 €

Efecto aplicado en parte plana. Medidas: A=40mm (+/-0,3mm); B=7,7mm (+/-0,3mm)



Referencia: 1066854



SWAROVSKI CRYSTAL > Strass Swarovski Crystal > Piezas para Pegar Strass Swarovski

Subfamilia Cristales Planos Strass Coated En Parte Plana

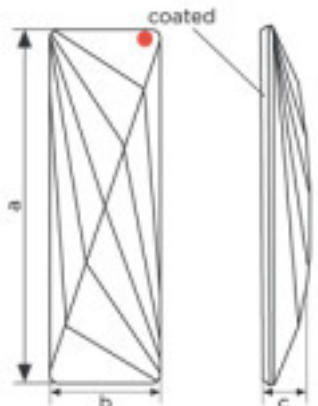
Imagen	Artículo	Descripción	Lote	Precio/Unidad
	113783405		1	16,07 €
	Chessboard Circle 2035/40 Sage Swarovski Crystal		3	12,85 €
	Efecto aplicado en parte plana. Medidas: A=40mm (+/-0,3mm); B=7,7mm (+/-0,3mm)		6	11,17 €
	Longitud (mm): 40			
				

	113783503		1	19,81 €
	Vigour Rectangle 2570/50x16mm CAL 'V' SI Swarovski Crystal		3	15,84 €
	Efecto aplicado en parte plana. Medidas: A=50,2mm (+/-0,3mm); B=16,2mm (+/-0,3mm); C=6,8(+/-0,3)		6	13,78 €
	Referencia: 1067315			
				

SWAROVSKI CRYSTAL > Strass Swarovski Crystal > Piezas para Pegar Strass Swarovski

Subfamilia Cristales Planos Strass Coated En Parte Plana

Imagen	Artículo	Descripción	Lote	Precio/Unidad
	113785401		1	18,89 €
	Stage 2085/40mm CAL V'SI		3	15,11 €
	Efecto aplicado en parte plana. Medidas: A=40mm (+/-0,3mm); B=16,9mm (+/-0,3mm)		6	13,14 €

