

# DISTANZIALI SPACERS

14-008	96	F072	101	F203	93	F351	95
14-032	99	F083	107	F208	86	F352	85
14-044	100	F085	106	F214	89	F353	85
14-045	100	F086	107	F215	89	F354	85
15-001	87	F087	106	F216	89	F356	84
15-002	87	F088	107	F228	97	F357	84
15-003	81	F090	106	F229	97	F359	84
15-004	88	F091	107	F230	97	F363	93
15-005	88	F093	106	F234	86	F363	96
15-007	88	F094	107	F235	86	F364	103
15-010	97	F095	106	F236	86	F365	103
15-011	97	F096	107	F237	86	F379	104
15-012	96	F098	106	F242	94	F381	90
15-015	88	F099	87	F245	89	F382	90
15-017	88	F101	100	F246	94	F388	83
15-019	97	F102	91	F254	82	F391	103
15-020	105	F103	87	F255	82	F392	81
15-027	106	F105	100	F256	82	F393	94
15-028	106	F106	91	F257	82	F394	103
15-030	102	F109	100	F258	82	F396	104
40-019	106	F110	91	F259	82	F400	104
40-020	106	F111	87	F260	82	F416	83
40-021	106	F113	100	F261	82	F427	89
F001	81	F114	91	F262	87	F429	99
F002	89	F115	91	F263	83	F433	94
F003	89	F118	91	F265	82	F434	83
F004	88	F119	99	F266	82	F437	86
F005	87	F120	90	F269	86	F438	84
F006	87	F121	90	F271	97	F439	84
F007	88	F125	98	F272	97	F440	103
F009	89	F125	101	F275	93	F441	102
F017	81	F128	98	F276	85	F442	88
F018	84	F128	101	F277	85	F443	83
F019	99	F129	97	F278	93	F445	83
F025	99	F130	99	F285	83	F446	102
F026	94	F131	106	F286	81	F449	98
F028	96	F132	106	F289	99	F449	101
F029	96	F133	106	F297	96	F451	83
F030	96	F135	87	F298	102	F457	105
F031	96	F136	83	F300	89	F458	107
F034	87	F137	83	F306	95	F459	107
F035	100	F144	83	F307	95	F460	107
F036	100	F150	96	F309	102	F461	82
F037	100	F151	97	F310	102	F462	83
F038	100	F158	92	F312	92	F478	102
F043	91	F162	87	F317	105	F479	102
F044	100	F163	90	F318	83	F488	85
F048	97	F164	89	F325	85	F489	85
F050	88	F166	105	F326	85	F490	94
F051	99	F173	92	F329	86	F492	81
F054	87	F176	98	F330	103	F498	82
F055	104	F176	101	F337	95	F504	106
F057	107	F178	104	F342	95	F507	105
F058	107	F179	98	F343	93	F509	105
F069	98	F179	101	F343	96	F510	105
F069	101	F183	93	F344	93	F511	102
F070	98	F187	89	F345	93	F513	105
F070	101	F194	86	F346	93	F514	83
F071	98	F200	85	F347	95		
F071	101	F201	86	F348	95		
F072	98	F202	86	F349	95		



**DISTANZIALI**  
**SPACERS**



**Lettura misure:**

*Measurement legenda:*

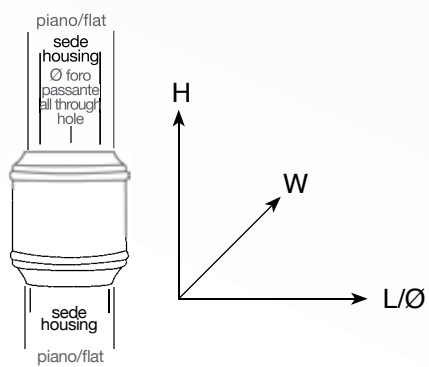

N.B. quota sedi specificata in NERO  
*housing dimension in BLACK*

L= Lunghezza/Length

H= Altezza/Height

W= Larghezza/Width

Ø= Diametro/Diameter

# DISTANZIALI SPACERS

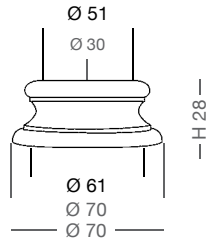

**F492**  
Ø70 x H28

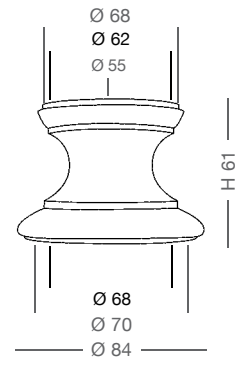

**F017**  
Ø84 x H61

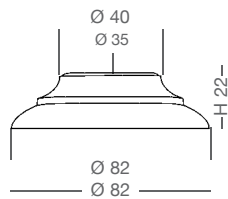

**F392**  
Ø82 x H22

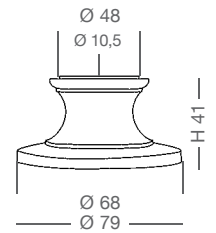
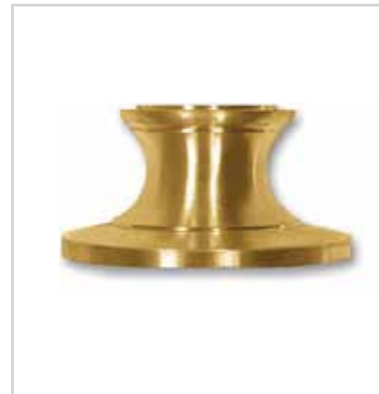

**F286**  
Ø79 x H41

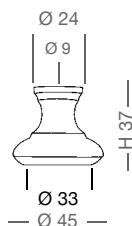
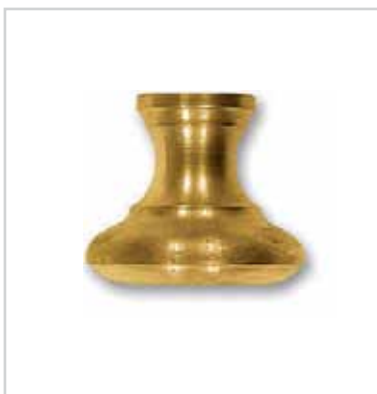

**F001**  
Ø45 x H37  
filetto/ thread M 10/1

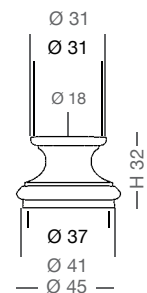

**15-003**  
Ø45 x H32

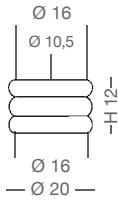

**F498**  
Ø20 x H12

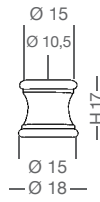

**F254**  
Ø18 x H17

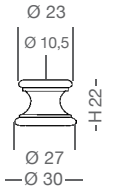

**F461**  
Ø30 x H22

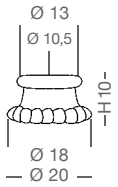

**F255**  
Ø20 x H10

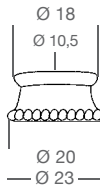
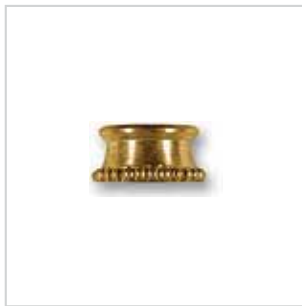

**F256**  
Ø23 x H11

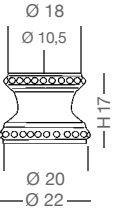

**F259**  
Ø22 x H17

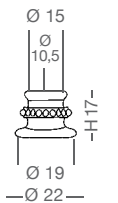

**F258**  
Ø22 x H17

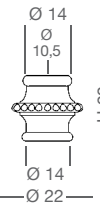

**F260**  
Ø22 x H22

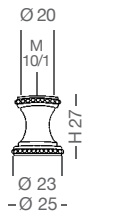

**F261**  
Ø25 x H27

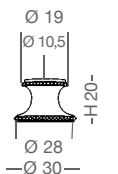

**F266**  
Ø30 x H20

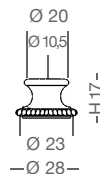
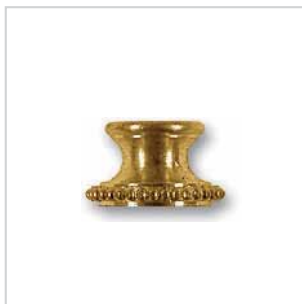

**F257**  
Ø28 x H17

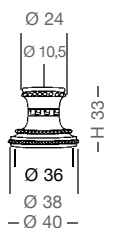
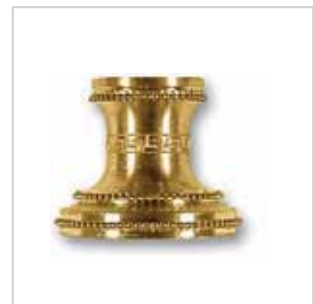

**F265**  
Ø40 x H33

# DISTANZIALI SPACERS

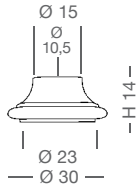

**F416**  
Ø30 x H14

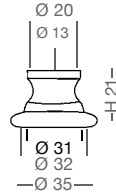

**F434**  
Ø35 x H21

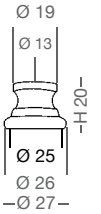

**F263**  
Ø27 x H20

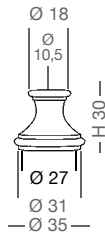

**F443**  
Ø35 x H30

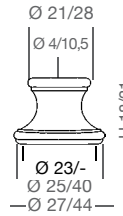
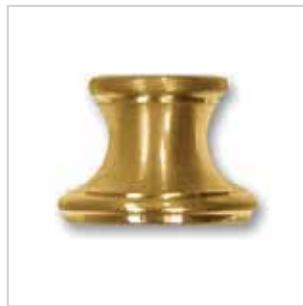

**F462**      **F451**  
Ø27 x H18      Ø44 x H31

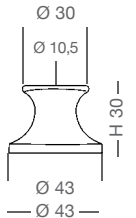

**F285**  
Ø43 x H30

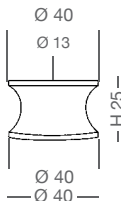

**F514**  
Ø40 x H25

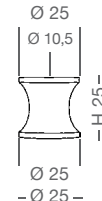

**F445**  
Ø25 x H25

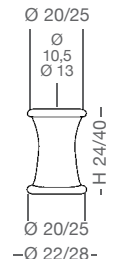
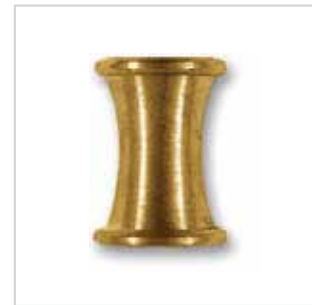

**F137**      **F136**  
Ø22 x H24      Ø28 x H40

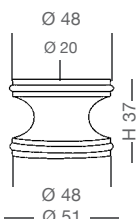

**F388**  
Ø51 x H37

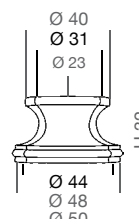

**F144**  
Ø50 x H32

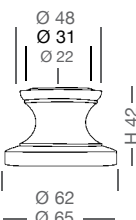

**F318**  
Ø65 x H42

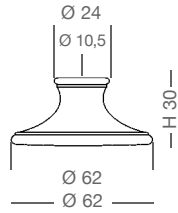

**F439**  
 $\varnothing 62 \times H 30$

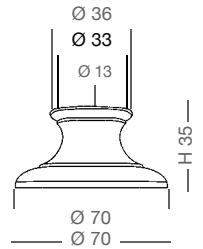

**F438**  
 $\varnothing 70 \times H 35$

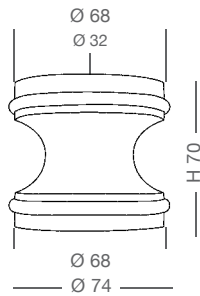

**F357**  
 $\varnothing 74 \times H 70$

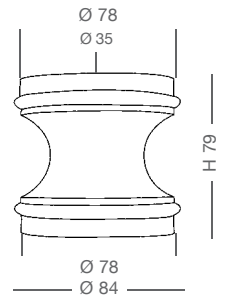

**F356**  
 $\varnothing 84 \times H 79$

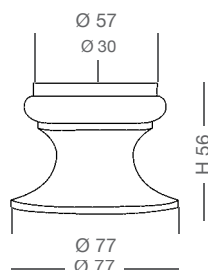

**F359**  
 $\varnothing 77 \times H 56$

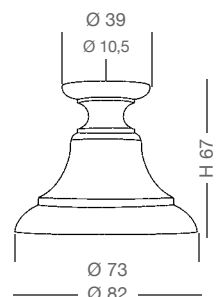

**F018**  
 $\varnothing 83 \times H 67$

# DISTANZIALI SPACERS

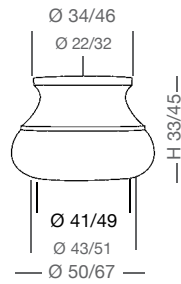

**F489**  
Ø50 x H33

**F488**  
Ø67 x H45

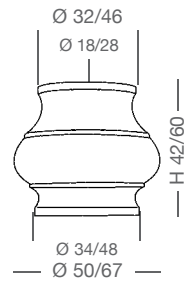

**F277**  
Ø50 x H42

**F276**  
Ø67 x H60

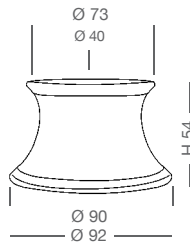

**F200**  
Ø92 x H54

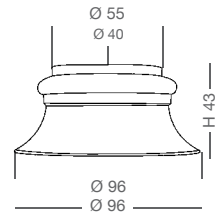

**F352**  
Ø96 x H43

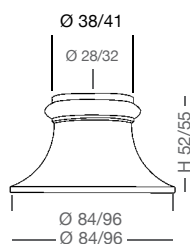

**F354**  
Ø84 x H52

**F353**  
Ø96 x H55

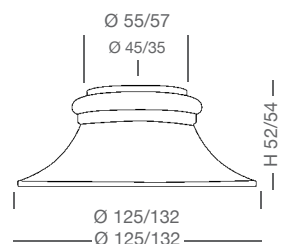

**F326**  
Ø125 x H52

**F325**  
Ø132 x H54



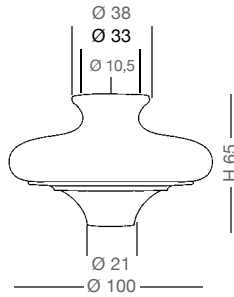

**F194**  
Ø100 x H65

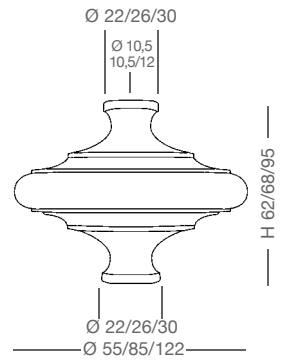

**F202**      **F208**  
Ø55 x H62      Ø122 x H95

**F201**  
Ø85 x H68

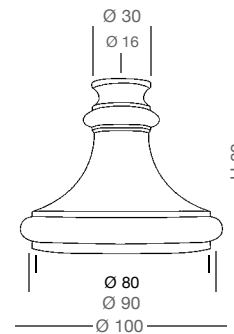

**F329**  
Ø100 x H82

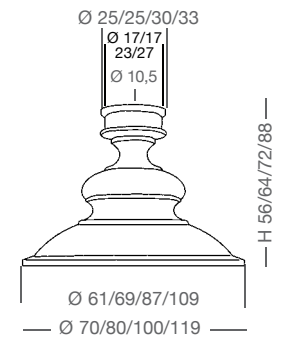

**F237**      **F235**  
Ø70 x H56      Ø100 x H72

**F236**      **F234**  
Ø80 x H64      Ø119 x H88

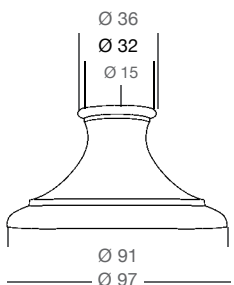
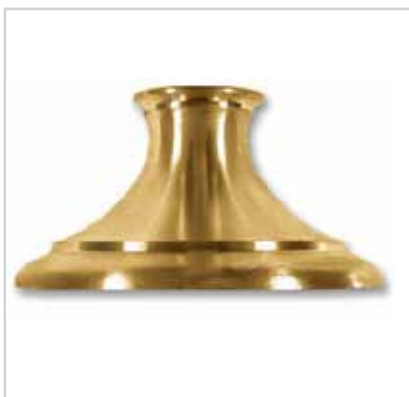

**F437**  
Ø97 x H54

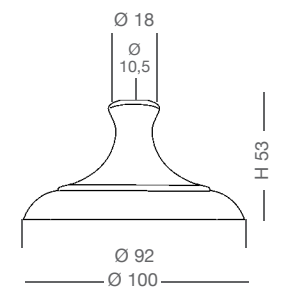

**F269**  
Ø100 x H53

# DISTANZIALI SPACERS

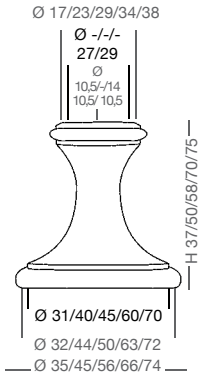

**F006**  
 $\varnothing 35 \times H37$

**F054**  
 $\varnothing 66 \times H70$

**15-002**  
 $\varnothing 45 \times H50$

**15-001**  
 $\varnothing 74 \times H75$

**F111**  
 $\varnothing 56 \times H58$

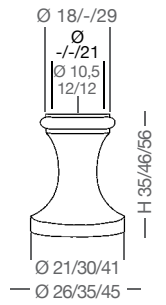

**F005**  
 $\varnothing 26 \times H35$

**F103**  
 $\varnothing 45 \times H56$

**F099**  
 $\varnothing 35 \times H46$

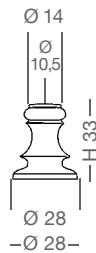

**F162**  
 $\varnothing 28 \times H33$

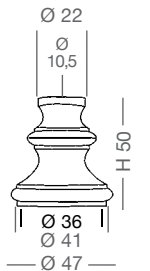

**F034**  
 $\varnothing 47 \times H50$



**F135**  
 $\varnothing 28 \times H50$

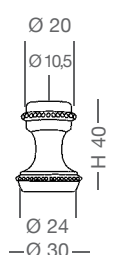

**F262**  
 $\varnothing 30 \times H40$

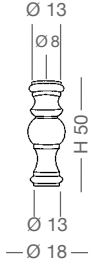

**F004**  
 Ø18 x H50  
 filetto/thread M 10/1



**F007**  
 Ø29 x H52

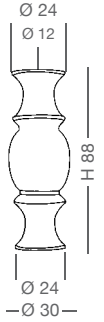

**F050**  
 Ø30 x H88

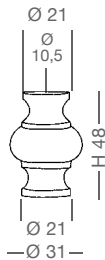

**15-005**  
 Ø31 x H48

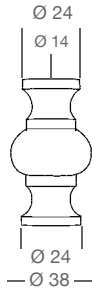

**15-004**  
 Ø38 x H68

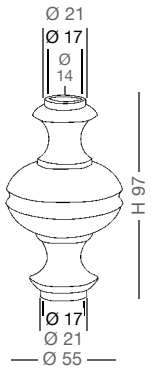

**15-007**  
 Ø55 x H97

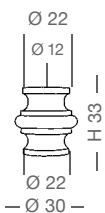

**15-015**  
 Ø30 x H33

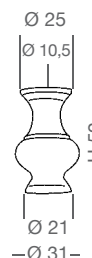

**15-017**  
 Ø31 x H52

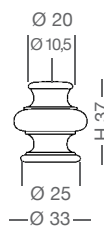

**F442**  
 Ø33 x H37

# DISTANZIALI SPACERS



**F003**  
Ø25 x H36

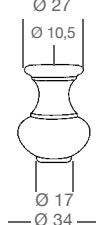

**F002**  
Ø34 x H47

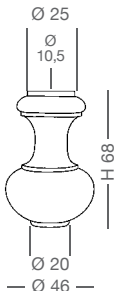
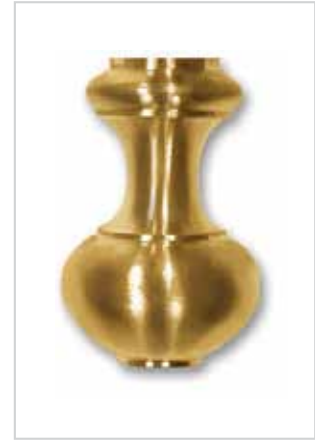

**F009**  
Ø46 x H68



**F214**  
Ø39 x H74



**F215**      **F216**  
Ø52 x H95      Ø67 x H115

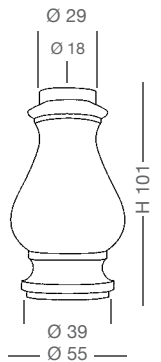
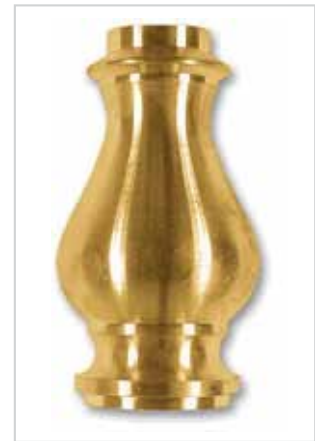

**F245**  
Ø55 x H101



**F187**  
Ø64 x H64

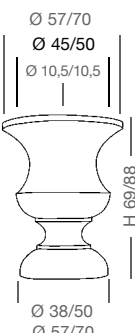

**F427**      **F300**  
Ø57 x H69      Ø70 x H88

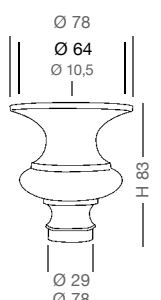

**F164**  
Ø78 x H83



**F163**  
 $\varnothing 36 \times H72$

**F121**  
 $\varnothing 58 \times H102$

**F120**  
 $\varnothing 48 \times H86$

**F382**  
 $\varnothing 72 \times H122$

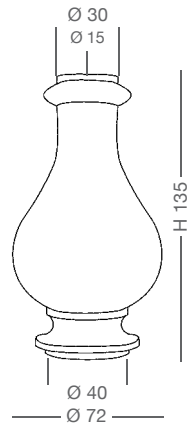

**F381**  
 $\varnothing 72 \times H135$



**DISTANZIALI  
SPACERS**

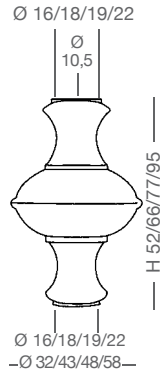

**F102**  
Ø32 x H52

**F110**  
Ø48 x H77

**F106**  
Ø43 x H66

**F114**  
Ø58 x H95  
foro / hole Ø13

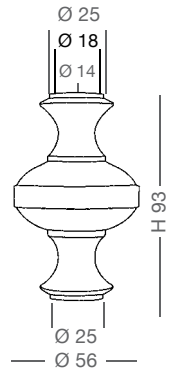
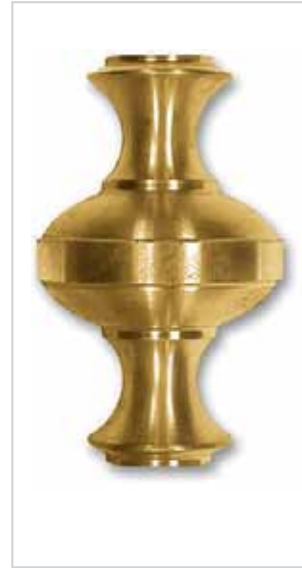

**F043**  
Ø56 x H93

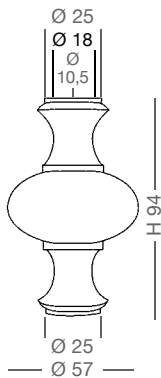

**F115**  
Ø57 x H94

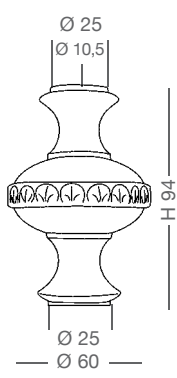

**F118**  
Ø60 x H94

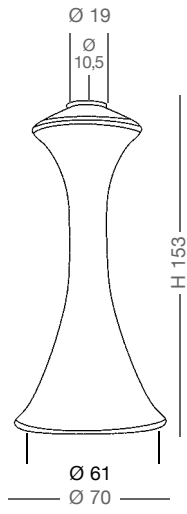

**F158**  
Ø70 x H153

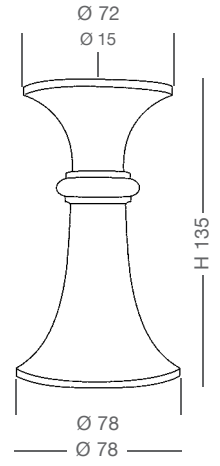

**F312**  
Ø78 x H135

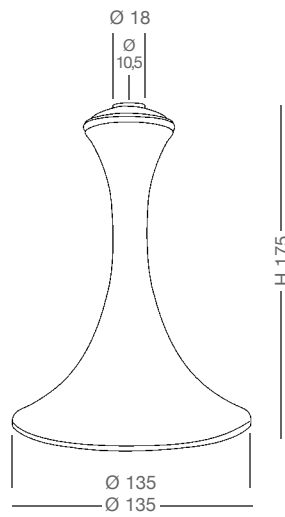

**F173**  
Ø135 x H175



# DISTANZIALI SPACERS

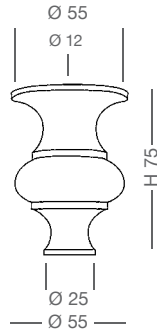

**F278**  
Ø55 x H75

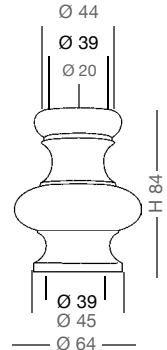

**F275**  
Ø64 x H84

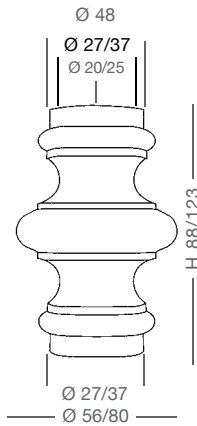

**F344**      **F345**  
Ø56 x H88      Ø80 x H123

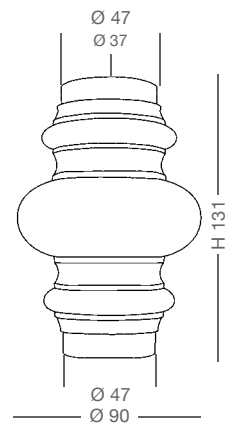

**F346**  
Ø90 x H131

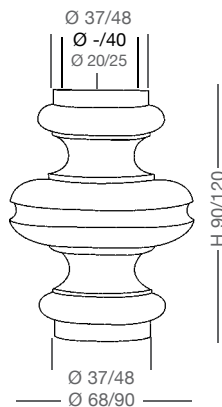

**F343**      **F363**  
Ø68 x H90      Ø90 x H120

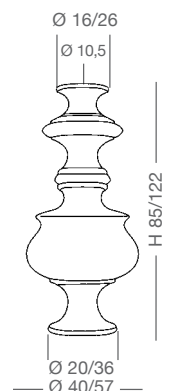

**F183**      **F203**  
Ø40 x H85      Ø57 x H122



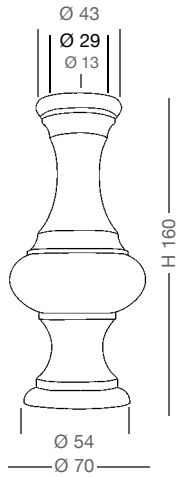

**F242**  
Ø70 x H160

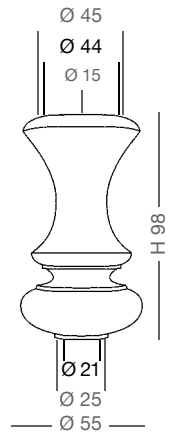

**F490**  
Ø55 x H98

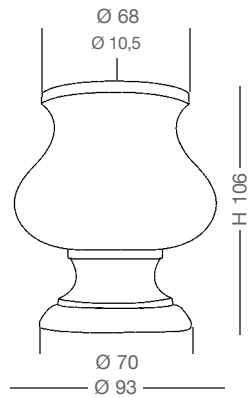

**F026**  
Ø93 x H106

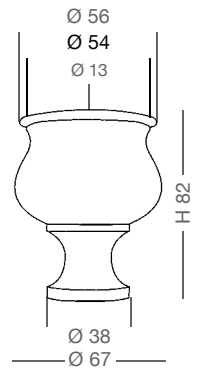

**F393**  
Ø67 x H82

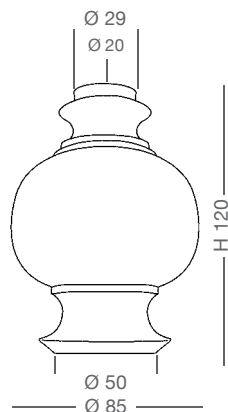

**F246**  
Ø85 x H120

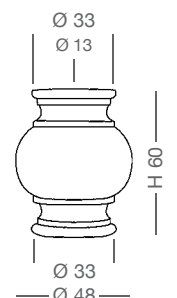

**F433**  
Ø48 x H60

# DISTANZIALI SPACERS

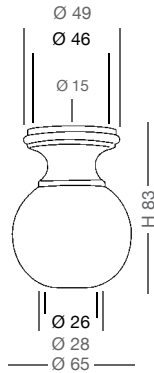

**F342**  
Ø65 x H83

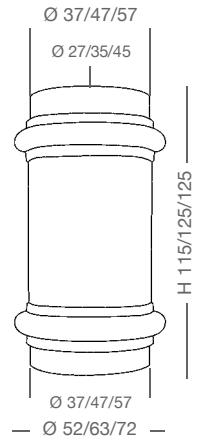

**F347**    **F348**    **F349**  
Ø52 x H115    Ø63 x H125    Ø72 x H125

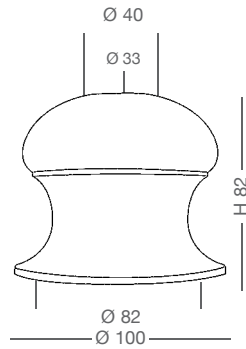

**F337**  
Ø100 x H82

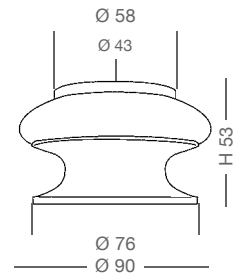

**F351**  
Ø90 x H53

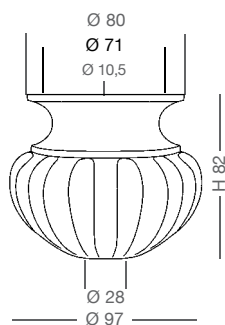

**F306**  
Ø95 x H82

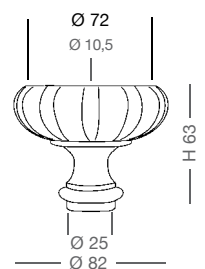

**F307**  
Ø82 x H63



**F031**  
L25 x W25 x H56

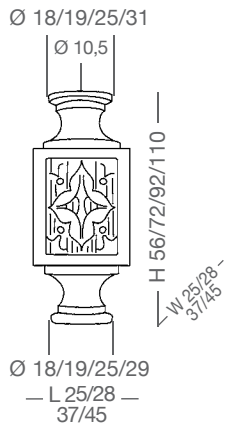

**F029** Ø int. 13  
L37 x W37 x H92



**F297**  
Ø47 x H63



**F030**  
L28 x W28 x H72

**F028**  
L45 x W45 x H110



**F150**  
Ø38 x H48



**F343**  
Ø68 x H90

**F363**  
Ø90 x H120

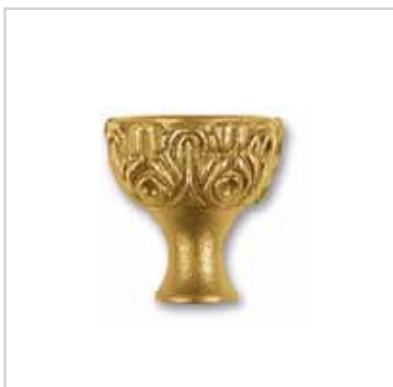
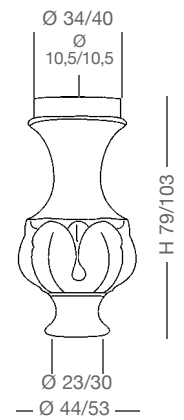

**14-008**  
Ø45 x H48

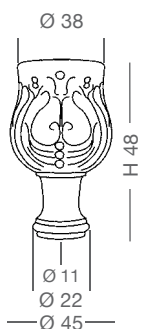

**15-012**  
Ø36 x H34

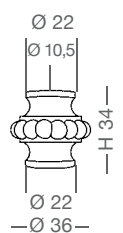

**DISTANZIALI  
SPACERS**



**F228** Ø42 x H74  
**F230** Ø70 x H113



**F151** Ø40 x H74  
**F048** Ø60 x H103

**F229** Ø57 x H92

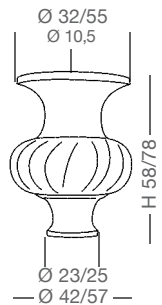

**F272** Ø42 x H58  
**F271** Ø57 x H78



**F129** Ø50 x H71



**15-011** Ø33 x H49  
**15-010** Ø41 x H66



**15-019** Ø44 x H63

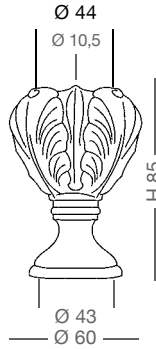

**F125**  
Ø60 x H85



**F176**      **F179**  
Ø70 x H112      Ø103 x H165

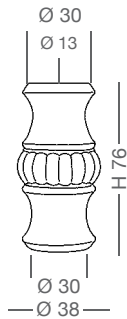

**F128**  
Ø38 x H76

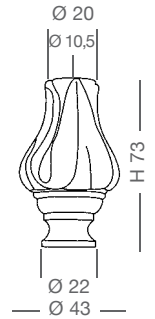

**F449**  
Ø43 x H73

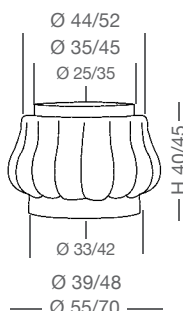

**F070**  
Ø55 x H40

**F069**  
Ø70 x H45

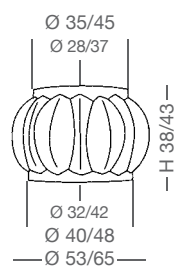

**F071**  
Ø53 x H38

**F072**  
Ø65 x H43

**DISTANZIALI  
SPACERS**

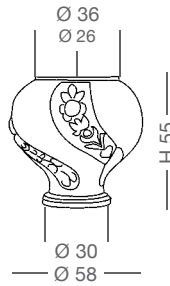

**F051**  
Ø58 x H55  
filetto/thread M 10/1

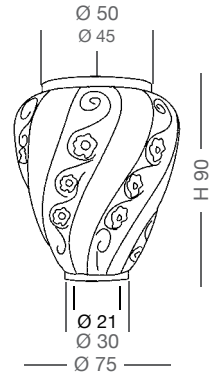

**F019**  
Ø75 x H90

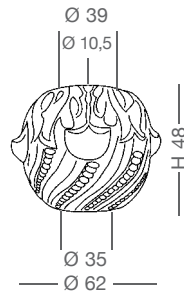

**F289**  
Ø62 x H48

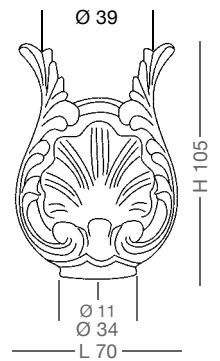

**14-032**  
L70 x W70 x H105

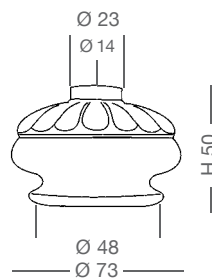

**F429**  
Ø73 x H50

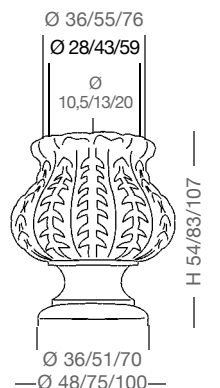

**F130**  
Ø50 x H54

**F119**  
Ø75 x H80

**F025**  
Ø100 x H107



**F101**  
Ø35 x H52

**F109**  
Ø52 x H77

**F105**  
Ø45 x H67

**F113**  
Ø62 x H92  
foro / hole Ø13

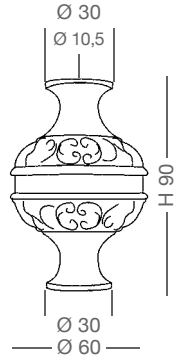

**F044**  
Ø60 x H90

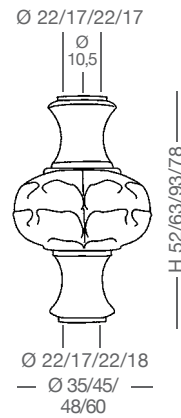

**F038**  
Ø35 x H52

**F036**  
Ø48 x H78

**F037**  
Ø45 x H63

**F035**  
Ø60 x H93  
foro / hole Ø13

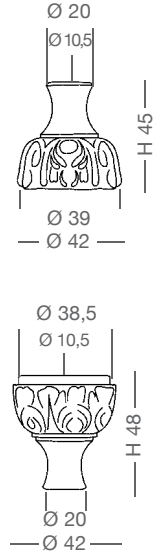

**14-045**  
Ø42 x H45

**14-044**  
Ø42 x H48

**DISTANZIALI  
SPACERS**

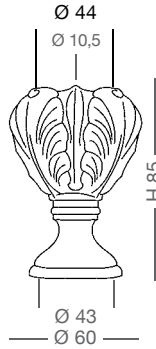

**F125**  
Ø60 x H85



**F176**      **F179**  
Ø70 x H112      Ø103 x H165

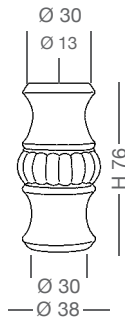

**F128**  
Ø38 x H76

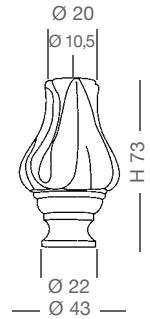

**F449**  
Ø43 x H73

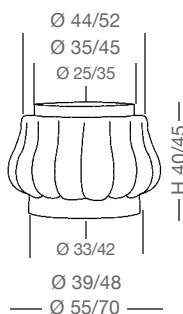

**F070**      **F069**  
Ø55 x H40      Ø70 x H45

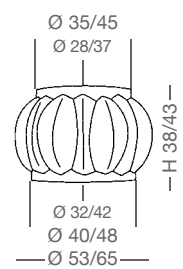

**F071**      **F072**  
Ø53 x H38      Ø65 x H43



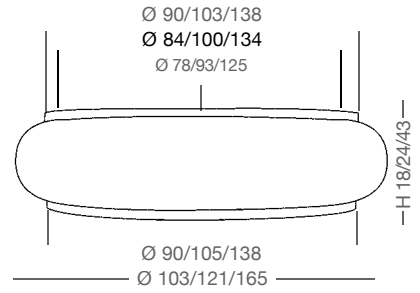

**F309**  $\varnothing$ 103 x H18  
**F298**  $\varnothing$ 121 x H24  
**F310**  $\varnothing$ 165 x H43

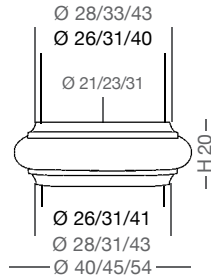

**F479**  $\varnothing$ 40 x H20  
**F478**  $\varnothing$ 45 x H20  
**F441**  $\varnothing$ 54 x H20

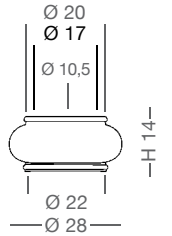

**F446**  $\varnothing$ 28 x H14

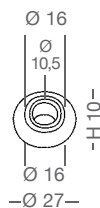

**F511**  $\varnothing$ 27 x H10

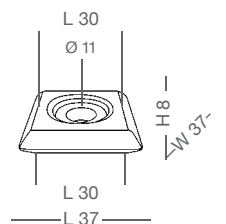

**15-030** L37 x W37 x H8

**DISTANZIALI  
SPACERS**

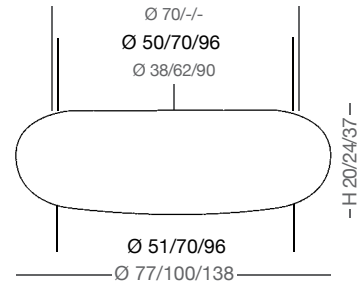

**F391** Ø77 x H20    **F330** Ø100 x H24    **F365** Ø138 x H37

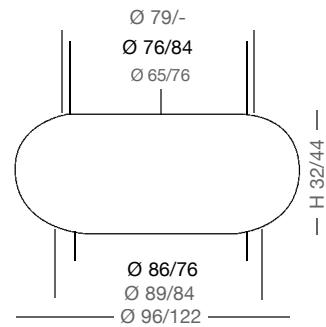

**F440** Ø96 x H32    **F364** Ø122 x H44

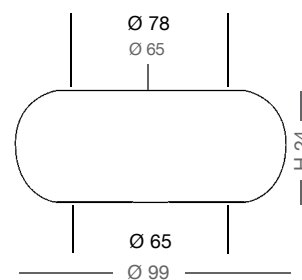

**F394** Ø99 x H24

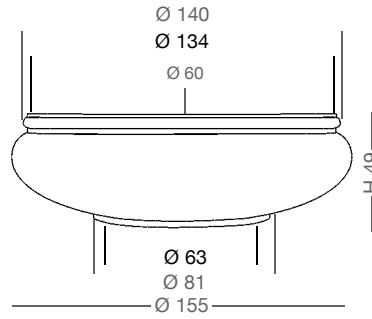

**F178**  
Ø155 x H49

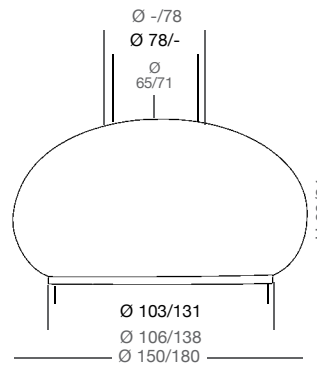

**F379**      **F396**  
Ø150 x H80      Ø180 x H94

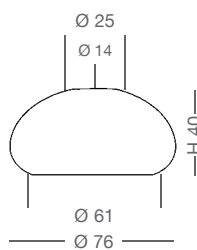

**F055**  
Ø76 x H40

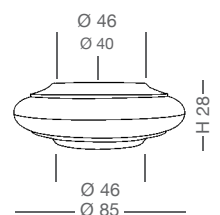

**F400**  
Ø85 x H28

# DISTANZIALI SPACERS

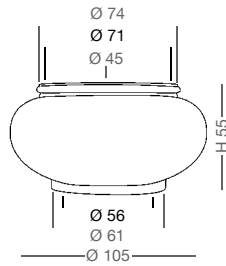

**F166**  
Ø105 x H55

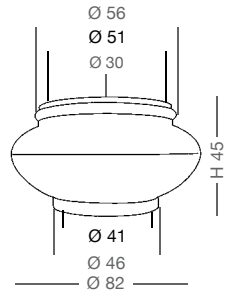

**F317**  
Ø82 x H45

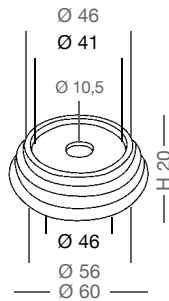

**F509**  
Ø60 x H20

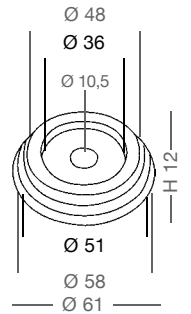

**F513**  
Ø61 x H12

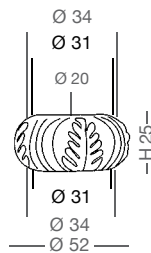

**15-020**  
Ø52 x H25

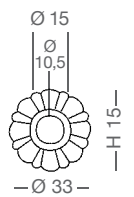

**F457**  
Ø33 x H15

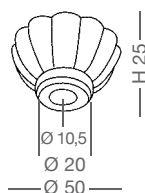
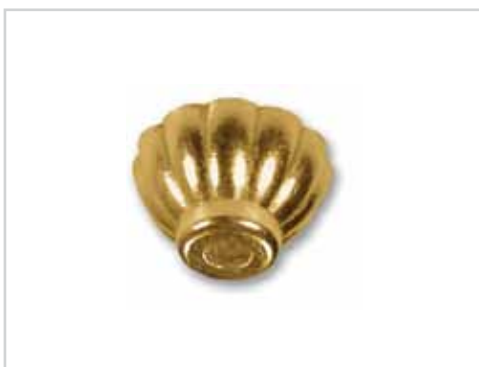

**F507**  
Ø50 x H25

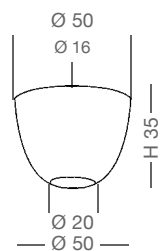

**F510**  
Ø50 x H35

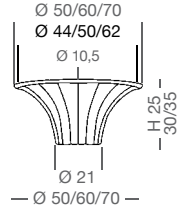

**F098** Ø50 x H25  
**F095** Ø60 x H30  
**F093** Ø70 x H35

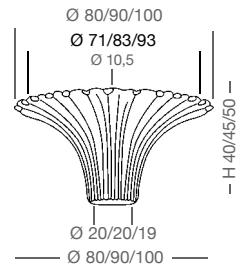

**F090** Ø80 x H40  
**F087** Ø90 x H45  
**F085** Ø100 x H50

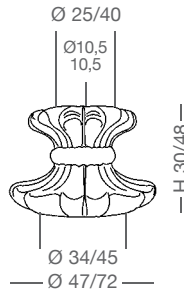
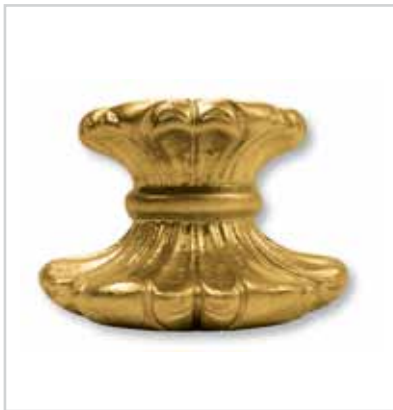

**15-028** Ø47 x H30  
**15-027** Ø72 x H48

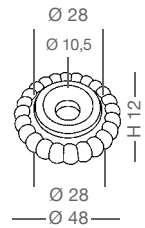

**F504** Ø48 x H12

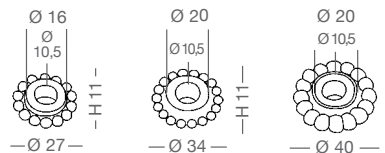

**40-021** Ø27 x H11  
 pressofuso/die casted

**F131** Ø27 x H11  
 stampato a caldo/hot pressing

**40-020** Ø34 x H11  
 pressofuso/die casted

**F132** Ø34 x H11  
 stampato a caldo/hot pressing

**40-019** Ø40 x H12  
 pressofuso/die casted

**F133** Ø40 x H12  
 stampato a caldo/hot pressing

# DISTANZIALI SPACERS

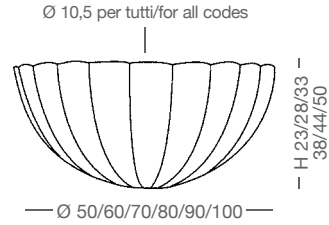

- |                          |                          |                           |
|--------------------------|--------------------------|---------------------------|
| <b>F096</b><br>Ø50 x H23 | <b>F094</b><br>Ø60 x H28 | <b>F091</b><br>Ø70 x H33  |
| <b>F088</b><br>Ø80 x H38 | <b>F086</b><br>Ø90 x H44 | <b>F083</b><br>Ø100 x H50 |

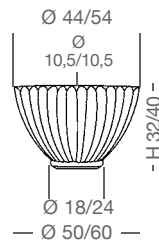

- |                          |                          |
|--------------------------|--------------------------|
| <b>F058</b><br>Ø50 x H32 | <b>F057</b><br>Ø60 x H40 |
|--------------------------|--------------------------|

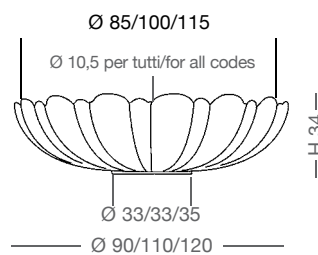

- |                          |                           |                           |
|--------------------------|---------------------------|---------------------------|
| <b>F458</b><br>Ø90 x H34 | <b>F459</b><br>Ø110 x H34 | <b>F460</b><br>Ø120 x H34 |
|--------------------------|---------------------------|---------------------------|