

Beads

Beads offer the highest standard available on the market. The high-quality precision cutting and the clear through-hole achieve immense brilliance and create unique sparkle. Rounded hole edges reduce the wear on thread and increase the durability of designs. Beads are available in a wide range of classical, elegant as well as playful shapes and cuts.

They come in a huge assortment of vibrant colors and effects to allow myriad possibilities for different design combinations. The main application techniques are beading, wiring, stringing, and weaving. Different hole diameters open up new unlimited application and design possibilities particularly for apparel and accessories embellishment.

Colors & Effects













Colors

 Crystal 001	 Blue Zircon 229
 White Opal 234	 <u>Denim Blue</u> 266
 Light Silk 261	 Black Diamond 215
 Silk 391	 Peridot 214
 Light Peach 362	 Erinte 360
 Vintage Rose 319	 Emerald 205
 Light Rose 223	 <u>Greige</u> 284
 Rose 209	 Light Colorado Topaz 246
 <u>Blush Rose</u> 257	 Jonquil 213
 Padparadscha 542	 Light Topaz 226
 Light Siam 227	 <u>Golden Topaz</u> 1003
 Scarlet 276	 Topaz 203
 Ruby 501	 <u>Light Amber</u> 1002
 Siam 208	 <u>Smoked Amber</u> 1001
 Fuchsia 502	 Jet 280
 Amethyst 204	
 Iris 219	
 Light Amethyst 212	
 Violet 371	
 Tanzanite 539	
 Light Sapphire 211	
 Light Azure 361	
 Aquamarine 202	
 Sapphire 206	
 Capri Blue 243	
 <u>Majestic Blue¹</u> 296	
 Montana 207	
 Light Turquoise 263	











Effects

 <u>Crystal Silver Shade</u> 001 SSHA	 Aquamarine Shimmer ² 202 SHIM
 Crystal Moonlight 001 MOL	 Black Diamond Shimmer ² 215 SHIM
 Crystal Aurore Boreale ² 001 AB	 Pacific Opal Shimmer ² 390 SHIM
 Crystal Shimmer ² 001 SHIM	 Chrysolite Opal Shimmer ² 294 SHIM
 Crystal Golden Shadow 001 GSHA	 Peridot Shimmer ² 214 SHIM
 Crystal Metallic Sunshine ^{2/*} 001 METSH	 Emerald Shimmer ² 205 SHIM
 <u>Crystal Rose Gold^{2/*}</u> 001 ROGL	 Erinte Shimmer ² 360 SHIM
 Crystal Antique Pink* 001 ANTP	 Light Colorado Topaz Shimmer ² 246 SHIM
 <u>Crystal Paradise Shine^{2/*}</u> 001 PARSH	 Yellow Opal Shimmer ² 231 SHIM
 Crystal Vitrail Medium* 001 VM	 Light Topaz Shimmer ² 226 SHIM
 Crystal Blue Shade* 001 BLSH	 Jet Shimmer ² 280 SHIM
 Crystal Light Chrome ^{2/*} 001 LTCH	
 Crystal Comet Argent Light* 001 CAL	
 Crystal Silver Night ^{2/*} 001 SINI	
 Jet Hematite ^{2/*} 280 HEM	

AB Effects

 Light Rose Aurore Boreale ² 223 AB
 Light Sapphire Aurore Boreale 211 AB
 Light Siam Aurore Boreale 227 AB
 Rose Aurore Boreale 209 AB
 Amethyst Aurore Boreale 204 AB
 Iris Aurore Boreale ² 219 AB
 Violet Aurore Boreale 371 AB
 Aquamarine Aurore Boreale 202 AB
 Sapphire Aurore Boreale 206 AB
 Capri Blue Aurore Boreale 243 AB
 Peridot Aurore Boreale 214 AB
 Jet Aurore Boreale ² 280 AB

Shimmer Effects

 White Opal Shimmer ² 234 SHIM
 Rose Water Opal Shimmer ² 395 SHIM
 Light Rose Shimmer ² 223 SHIM
 Rose Shimmer ² 209 SHIM
 Light Siam Shimmer ² 227 SHIM
 <u>Scarlet Shimmer²</u> 276 SHIM
 Siam Shimmer ² 208 SHIM
 Amethyst Shimmer ² 204 SHIM
 Cyclamen Opal Shimmer ² 398 SHIM
 Light Amethyst Shimmer ² 212 SHIM
 Light Sapphire Shimmer ² 211 SHIM

Numerical Order

001	Crystal	208	Siam	243 AB	Capri Blue Aurore Boreale
001 AB	Crystal Aurore Boreale	208 SHIM	Siam Shimmer	246	Light Colorado Topaz
001 ABB	Crystal Aurore Boreale B	208 SHIM2	Siam Shimmer 2x	246 SHIMB	Light Colorado Topaz Shimmer B
001 AB2	Crystal Aurore Boreale 2x	209	Rose	246 SHIM2	Light Colorado Topaz Shimmer 2x
001 ANTP	Crystal Antique Pink*	209 AB	Rose Aurore Boreale	<u>257</u>	Blush Rose
001 BLSB	Crystal Blue Shade B*	209 SHIM	Rose Shimmer	261	Light Silk
001 BLSH	Crystal Blue Shade*	209 SHIM2	Rose Shimmer 2x	263	Light Turquoise
001 CAL	Crystal Comet Argent Light*	211	Light Sapphire	<u>266</u>	<u>Denim Blue</u>
001 GSHA	Crystal Golden Shadow	211 AB	Light Sapphire Aurore Boreale	<u>276</u>	<u>Scarlet</u>
001 GSHAB	Crystal Golden Shadow B	211 SHIM2	Light Sapphire Shimmer 2x	<u>276 SHIM2</u>	<u>Scarlet Shimmer 2x</u>
001 LTCH	Crystal Light Chrome*	211 SHIMB	Light Sapphire Shimmer B	280	Jet
001 LTCHB	Crystal Light Chrome B*	212	Light Amethyst	280 AB	Jet Aurore Boreale
001 LTCH2	Crystal Light Chrome 2x*	212 SHIM	Light Amethyst Shimmer	280 AB2	Jet Aurore Boreale 2x
001 METSH	Crystal Metallic Sunshine*	212 SHIM2	Light Amethyst Shimmer 2x	280 HEM	Jet Hematite*
001 METSH2	Crystal Metallic Sunshine 2x*	213	Jonquil	280 HEM2	Jet Hematite 2x*
001 MOL	Crystal Moonlight	214	Peridot	280 SHIM2	Jet Shimmer 2x
001 MTSHB	Crystal Metallic Sunshine B*	214 AB	Peridot Aurore Boreale	<u>284</u>	<u>Greige</u>
001 PARSH	Crystal Paradise Shine*	214 SHIM	Peridot Shimmer	294 SHIM	Chrysolite Opal Shimmer
001 PARSH2	Crystal Paradise Shine 2x*	214 SHIM2	Peridot Shimmer 2x	294 SHIMB	Chrysolite Opal Shimmer B
001 ROGB2	Crystal Rose Gold B 2x*	215	Black Diamond	294 SHIM2	Chrysolite Opal Shimmer 2x
001 ROGL	Crystal Rose Gold*	215 SHIM	Black Diamond Shimmer	<u>296</u>	<u>Majestic Blue¹</u>
001 ROGL2	Crystal Rose Gold 2x*	215 SHIM2	Black Diamond Shimmer 2x	319	Vintage Rose
001 SHIM	Crystal Shimmer	215 SHIMB	Black Diamond Shimmer B	360	Erinite
001 SHIMB	Crystal Shimmer B	<u>219</u>	<u>Iris</u>	360 SHIMB	Erinite Shimmer B
001 SHIM2	Crystal Shimmer 2x	<u>219 AB</u>	<u>Iris Aurore Boreale</u>	360 SHIM2	Erinite Shimmer 2x
001 SINI	Crystal Silver Night*	<u>219 AB2</u>	<u>Iris Aurore Boreale 2x</u>	361	Light Azore
001 SINIB	Crystal Silver Night B*	223	Light Rose	362	Light Peach
001 SINI2	Crystal Silver Night 2x*	223 AB	Light Rose Aurore Boreale	371	Violet
001 SSHA	Crystal Silver Shade	223 AB2	Light Rose Aurore Boreale 2x	371 AB	Violet Aurore Boreale
001 VM	Crystal Vitrail Medium*	223 SHIM	Light Rose Shimmer	390 SHIM	Pacific Opal Shimmer
001 VMB	Crystal Vitrail Medium B*	223 SHIM2	Light Rose Shimmer 2x	390 SHIMB	Pacific Opal Shimmer B
202	Aquamarine	226	Light Topaz	390 SHIM2	Pacific Opal Shimmer 2x
202 AB	Aquamarine Aurore Boreale	226 SHIM2	Light Topaz Shimmer 2x	391	Silk
202 SHIM	Aquamarine Shimmer	227	Light Siam	395 SHIM	Rose Water Opal Shimmer
202 SHIM2	Aquamarine Shimmer 2x	227 AB	Light Siam Aurore Boreale	395 SHIMB	Rose Water Opal Shimmer B
203	Topaz	227 SHIMB	Light Siam Shimmer B	395 SHIM2	Rose Water Opal Shimmer 2x
204	Amethyst	227 SHIM2	Light Siam Shimmer 2x	398 SHIM	Cyclamen Opal Shimmer
204 AB	Amethyst Aurore Boreale	229	Blue Zircon	398 SHIM2	Cyclamen Opal Shimmer 2x
204 SHIM	Amethyst Shimmer	231 SHIM	Yellow Opal Shimmer	501	Ruby
204 SHIM2	Amethyst Shimmer 2x	231 SHIM2	Yellow Opal Shimmer 2x	502	Fuchsia
205	Emerald	234	White Opal	539	Tanzanite
205 SHIM2	Emerald Shimmer 2x	234 SHIM	White Opal Shimmer	542	Padparadscha
206	Sapphire	234 SHIMB	White Opal Shimmer B	<u>1001</u>	<u>Smoked Amber</u>
206 AB	Sapphire Aurore Boreale	234 SHIM2	White Opal Shimmer 2x	<u>1002</u>	<u>Light Amber</u>
207	Montana	243	Capri Blue	<u>1003</u>	<u>Golden Topaz</u>

Alphabetical Order

Amethyst (204)
 Amethyst Aurore Boreale (204 AB)
 Amethyst Shimmer (204 SHIM)
 Amethyst Shimmer 2x (204 SHIM2)
 Aquamarine (202)
 Aquamarine Aurore Boreale (202 AB)
 Aquamarine Shimmer (202 SHIM)
 Aquamarine Shimmer 2x (202 SHIM2)
 Black Diamond (215)
 Black Diamond Shimmer (215 SHIM)
 Black Diamond Shimmer 2x (215 SHIM2)
 Black Diamond Shimmer B (215 SHIMB)
 Blue Zircon (229)
 Blush Rose (257)
 Capri Blue (243)
 Capri Blue Aurore Boreale (243 AB)
 Chrysolite Opal Shimmer (294 SHIM)
 Chrysolite Opal Shimmer B (294 SHIMB)
 Chrysolite Opal Shimmer 2x (294 SHIM2)
 Crystal (001)
 Crystal Antique Pink (001 ANTP)*
 Crystal Aurore Boreale (001 AB)
 Crystal Aurore Boreale B (001 ABB)
 Crystal Aurore Boreale 2x (001 AB2)
 Crystal Blue Shade (001 BLSH)*
 Crystal Blue Shade B (001 BLSB)*
 Crystal Comet Argent Light (001 CAL)*
 Crystal Golden Shadow (001 GSHA)
 Crystal Golden Shadow B (001 GSHAB)
 Crystal Light Chrome (001 LTCH)*
 Crystal Light Chrome B (001 LTCHB)*
 Crystal Light Chrome 2x (001 LTCH2)*
 Crystal Metallic Sunshine (001 METSH)*
 Crystal Metallic Sunshine B (001 MTSHB)*
 Crystal Metallic Sunshine 2x (001 METSH2)*
 Crystal Moonlight (001 MOL)
 Crystal Paradise Shine (001 PARSH)*
 Crystal Paradise Shine 2x (001 PARSH2)*
 Crystal Rose Gold (001 ROGL)*
 Crystal Rose Gold B 2x (001 ROGB2)*
 Crystal Rose Gold 2x (001 ROGL2)*
 Crystal Shimmer (001 SHIM)
 Crystal Shimmer B (001 SHIMB)
 Crystal Shimmer 2x (001 SHIM2)
 Crystal Silver Night (001 SINI)*

Crystal Silver Night B (001 SINIB)*
 Crystal Silver Night 2x (001 SINI2)*
 Crystal Silver Shade (001 SSHA)
 Crystal Vitrail Medium (001 VM)*
 Crystal Vitrail Medium B (001 VMB)*
 Cyclamen Opal Shimmer (398 SHIM)
 Cyclamen Opal Shimmer 2x (398 SHIM2)
 Denim Blue (266)
 Emerald (205)
 Emerald Shimmer 2x (205 SHIM2)
 Erinite (360)
 Erinite Shimmer B (360 SHIMB)
 Erinite Shimmer 2x (360 SHIM2)
 Fuchsia (502)
 Golden Topaz (1003)
 Greige (284)
 Iris (219)
 Iris Aurore Boreale (219 AB)
 Iris Aurore Boreale 2x (219 AB2)
 Jet (280)
 Jet Aurore Boreale (280 AB)
 Jet Aurore Boreale 2x (280 AB2)
 Jet Hematite (280 HEM)*
 Jet Hematite 2x (280 HEM2)*
 Jet Shimmer 2x (280 SHIM2)
 Jonquil (213)
 Light Amber (1002)
 Light Amethyst (212)
 Light Amethyst Shimmer (212 SHIM)
 Light Amethyst Shimmer 2x (212 SHIM2)
 Light Azure (361)
 Light Colorado Topaz (246)
 Light Colorado Topaz Shimmer B (246 SHIMB)
 Light Colorado Topaz Shimmer 2x (246 SHIM2)
 Light Peach (362)
 Light Rose (223)
 Light Rose Aurore Boreale (223 AB)
 Light Rose Aurore Boreale 2x (223 AB2)
 Light Rose Shimmer (223 SHIM)
 Light Rose Shimmer 2x (223 SHIM2)
 Light Sapphire (211)
 Light Sapphire Aurore Boreale (211 AB)
 Light Sapphire Shimmer 2x (211 SHIM2)
 Light Sapphire Shimmer B (211 SHIMB)
 Light Siam (227)

Light Siam Aurore Boreale (227 AB)
 Light Siam Shimmer B (227 SHIMB)
 Light Siam Shimmer 2x (227 SHIM2)
 Light Silk (261)
 Light Topaz (226)
 Light Topaz Shimmer 2x (226 SHIM2)
 Light Turquoise (263)
 Majestic Blue (296)¹
 Montana (207)
 Pacific Opal Shimmer (390 SHIM)
 Pacific Opal Shimmer B (390 SHIMB)
 Pacific Opal Shimmer 2x (390 SHIM2)
 Padparadscha (542)
 Peridot (214)
 Peridot Aurore Boreale (214 AB)
 Peridot Shimmer (214 SHIM)
 Peridot Shimmer 2x (214 SHIM2)
 Rose (209)
 Rose Aurore Boreale (209 AB)
 Rose Shimmer (209 SHIM)
 Rose Shimmer 2x (209 SHIM2)
 Rose Water Opal Shimmer (395 SHIM)
 Rose Water Opal Shimmer B (395 SHIMB)
 Rose Water Opal Shimmer 2x (395 SHIM2)
 Ruby (501)
 Sapphire (206)
 Sapphire Aurore Boreale (206 AB)
 Scarlet (276)
 Scarlet Shimmer 2x (276 SHIM2)
 Siam (208)
 Siam Shimmer (208 SHIM)
 Siam Shimmer 2x (208 SHIM2)
 Silk (391)
 Smoked Amber (1001)
 Tanzanite (539)
 Topaz (203)
 Vintage Rose (319)
 Violet (371)
 Violet Aurore Boreale (371 AB)
 White Opal (234)
 White Opal Shimmer (234 SHIM)
 White Opal Shimmer B (234 SHIMB)
 White Opal Shimmer 2x (234 SHIM2)
 Yellow Opal Shimmer (231 SHIM)
 Yellow Opal Shimmer 2x (231 SHIM2)

03

For details on available colors and effects for each article within the product groups, please see the product matrix of the respective item in the Collection 2021. For color and effect samples, please see the corresponding color chart.

Please check the Swarovski Collection 2021 for all available crystal color and AB coating variations.

The plating resistance of effects is tested according to Swarovski's plating guidelines (SWAROVSKI.COM/S-PROFESSIONALS). Customers are advised to carry out their own tests if their plating parameters diverge from Swarovski plating guidelines.

* Crystals are not resistant to plating and similar processing.

¹ Majestic Blue's intense ultramarine hue is difficult to recreate accurately in print due to the fact that the CMYK color spectrum is used in the printing process. In order to get a truer impression of its color, please use RGB digital pictures or, ideally, ask for actual samples.

² Effect is also available as 2x.

Classic Colors/Effects: This color range offers a wide choice of traditional Swarovski crystal colors and effects.

Exclusive Colors/Effects: This color range is offered exclusively by Swarovski.

Colors and effects can appear different when illuminated with different light sources. Swarovski uses standard light source D50 for color decision and comparison. Slight changes in shades are unavoidable. Colors may vary according to cut and foiling.

The composition of Advanced Crystal is compliant with regulatory industry norms and laws regarding the restriction or prohibition of certain substances in the most relevant segments of our customers. Please note that the compliance of the crystal colors Light Siam and Siam varies according to certain industry regulations. Those regulations are indicated with * in the compliance overview. Scarlet (option to Lt. Siam) conform to all CLEAR-lists.

For further information please visit swarovski.com/s-professionals

© 2021 D. Swarovski Distribution GmbH

Summary

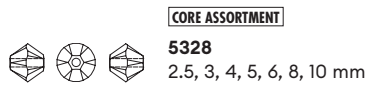
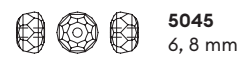
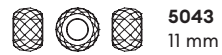
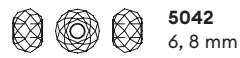
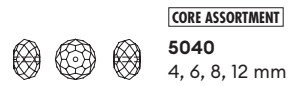
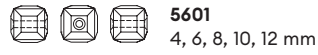
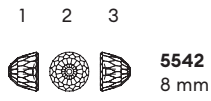
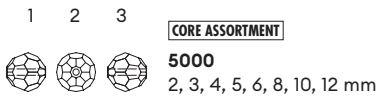

CORE ASSORTMENT

5000 Classic Bead



Size	2 mm	3 mm	4 mm	5 mm	6 mm	8 mm	10 mm	12 mm
------	------	------	------	------	------	------	-------	-------

Crystal

Crystal (001)

Colors

Plain Colors

- Amethyst (204)
- Aquamarine (202)
- Black Diamond (215)
- Blue Zircon (229)
- Capri Blue (243)
- Denim Blue (266)
- Emerald (205)
- Erinite (360)
- Fuchsia (502)
- Golden Topaz (1003)*
- Iris (219)
- Jet (280)
- Jonquil (213)
- Light Amber (1002)*
- Light Amethyst (212)
- Light Azore (361)
- Light Colorado Topaz (246)
- Light Rose (223)
- Light Sapphire (211)
- Light Siam (227)
- Light Topaz (226)
- Light Turquoise (263)
- Montana (207)
- Peridot (214)
- Rose (209)
- Sapphire (206)
- Scarlet (276)
- Siam (208)
- Silk (391)
- Smoked Amber (1001)*

Crystal (001)	◆	◆	◆	◆	◆	◆	◆	■
Amethyst (204)	◆	◆	◆	◆	◆	◆	◆	
Aquamarine (202)	◆	◆	◆	◆	◆	◆	◆	
Black Diamond (215)			■		■	■		
Blue Zircon (229)			■		■	■		
Capri Blue (243)			■		■	■		
Denim Blue (266)			■		■	■		
Emerald (205)	◆	◆	◆	◆	◆	◆	◆	
Erinite (360)			■		■	■		
Fuchsia (502)			■		■	■		
Golden Topaz (1003)*			■		■	■		
Iris (219)			■		■	■		
Jet (280)	◆	◆	◆	◆	◆	◆	◆	
Jonquil (213)			■		■	■		
Light Amber (1002)*			■		■	■		
Light Amethyst (212)			■		■	■		
Light Azore (361)			■		■	■		
Light Colorado Topaz (246)	◆	◆	◆	◆	◆	◆	◆	
Light Rose (223)	◆	◆	◆	◆	◆	◆	◆	
Light Sapphire (211)			■		■	■		
Light Siam (227)			■		■	■	■	
Light Topaz (226)			■		■	■		
Light Turquoise (263)			■		■	■		
Montana (207)			■		■	■		
Peridot (214)			■		■	■		
Rose (209)			■		■	■		
Sapphire (206)			■		■	■		
Scarlet (276)	◆	◆	◆	◆	◆	◆	◆	
Siam (208)			■		■	■	■	
Silk (391)			■		■	■		
Smoked Amber (1001)*			■		■	■		

* All colors with a 4-digit color code (i.e. Golden Topaz) are fully customizable with shorter lead times and lower MOQs compared to our 3-digit colors. Please get in touch with the Customer Service for a time and quantity estimation of your desired variant.

◆ Core Assortment

5000	Size							
	2 mm	3 mm	4 mm	5 mm	6 mm	8 mm	10 mm	12 mm
Tanzanite (539)			■		■	■		
Topaz (203)			■		■	■		
Vintage Rose (319)			■		■	■		
Violet (371)			■		■	■		
Opal Colors								
White Opal (234)		■	■		■	■		
Crystal Effects								
Transparent Effects								
Crystal Aurore Boreale (001 AB)	■	■	■	■	■	■	■	■
Crystal Blue Shade (001 BLSH)			■		■	■		
Crystal Golden Shadow (001 GSHA)	■	■	■		■	■	■	
Crystal Moonlight (001 MOL)	■		■		■	■		
Crystal Shimmer (001 SHIM)			■		■	■		
Crystal Silver Night (001 SINI)	■	■	■		■	■		
Crystal Silver Shade (001 SSHA)	■	■	■		■	■		
Metallic Effects								
Crystal Light Chrome (001 LTCH)		■	■		■	■		
Crystal Rose Gold (001 ROGL)		■	■		■	■		
Color Effects								
Transparent Effects								
Amethyst Shimmer (204 SHIM)			■		■	■		
Aquamarine Shimmer (202 SHIM)			■		■	■		
Chrysolite Opal Shimmer (294 SHIM)			■		■	■		
Cyclamen Opal Shimmer (398 SHIM)			■		■	■		
Jet Aurore Boreale (280 AB)			■		■	■		
Light Amethyst Shimmer (212 SHIM)			■		■	■		
Light Rose Shimmer (223 SHIM)			■		■	■		
Light Siam Aurore Boreale (227 AB)			■		■	■		
Pacific Opal Shimmer (390 SHIM)			■		■	■		
Peridot Shimmer (214 SHIM)			■		■	■		
Rose Aurore Boreale (209 AB)			■		■	■		
Rose Shimmer (209 SHIM)			■		■	■		
Rose Water Opal Shimmer (395 SHIM)			■		■	■		
Siam Shimmer (208 SHIM)			■		■	■		
White Opal Shimmer (234 SHIM)			■		■	■		
Yellow Opal Shimmer (231 SHIM)			■		■	■		

5003 Disco Ball Bead



Size
6 mm
8 mm
10 mm
12 mm

Crystal

Crystal (001)

Crystal Effects

Transparent Effects

Crystal Aurore Boreale (001 AB)

5020 Helix Bead



Size
6 mm
8 mm
10 mm

Crystal

Crystal (001)

Crystal Effects

Transparent Effects

Crystal Aurore Boreale (001 AB)

Crystal Golden Shadow (001 GSHA)

5028/4 Crystal Globe Bead

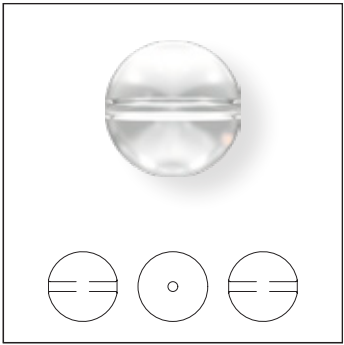

Size
6 mm
8 mm
10 mm

Crystal

Crystal (001)

Crystal Effects

Transparent Effects

Crystal Aurore Boreale (001 AB)

CORE ASSORTMENT

5040 Briolette Bead

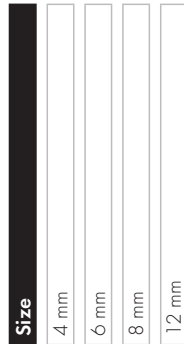

Crystal

Crystal (001)

Colors

Plain Colors

Amethyst (204)

Aquamarine (202)

Emerald (205)

Erinite (360)

Iris (219)

Jet (280)

Light Amethyst (212)

Light Colorado Topaz (246)

Light Rose (223)

Light Sapphire (211)

Light Siam (227)

Light Topaz (226)

Light Turquoise (263)

Scarlet (276)

Siam (208)

Tanzanite (539)

Violet (371)

Crystal Effects

Transparent Effects

Crystal Aurore Boreale (001 AB)

Crystal Golden Shadow (001 GSHA)

Crystal Shimmer 2x (001 SHIM2)

Crystal Silver Night (001 SINI)

Crystal Silver Shade (001 SSHA)

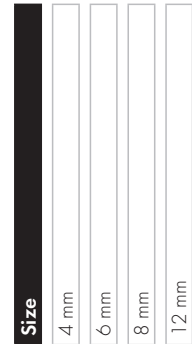
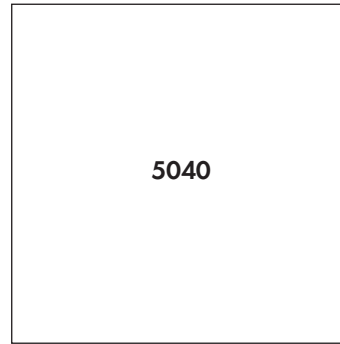

Color Effects

Transparent Effects

Amethyst Shimmer 2x (204 SHIM2)

Aquamarine Shimmer 2x (202 SHIM2)

Black Diamond Shimmer 2x (215 SHIM2)

Chrysolite Opal Shimmer 2x (294 SHIM2)

Erinite Shimmer 2x (360 SHIM2)

Light Amethyst Shimmer 2x (212 SHIM2)

Light Colorado Topaz Shimmer 2x (246 SHIM2)

Light Rose Shimmer 2x (223 SHIM2)

Light Sapphire Shimmer 2x (211 SHIM2)

Light Siam Shimmer 2x (227 SHIM2)

Light Topaz Shimmer 2x (226 SHIM2)

Pacific Opal Shimmer 2x (390 SHIM2)

Rose Water Opal Shimmer 2x (395 SHIM2)

White Opal Shimmer 2x (234 SHIM2)

5042 Briolette XL Hole Bead

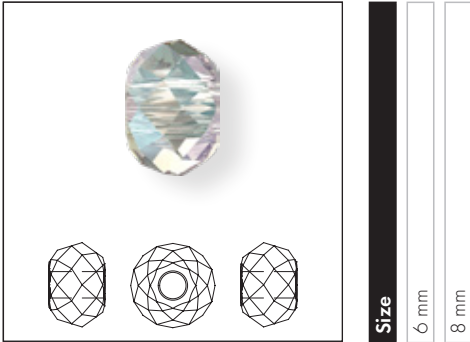

Size
6 mm
8 mm

Crystal Effects

Transparent Effects

Crystal Shimmer 2x (001 SHIM2)

Color Effects

Transparent Effects

- Amethyst Shimmer 2x (204 SHIM2)
- Aquamarine Shimmer 2x (202 SHIM2)
- Emerald Shimmer 2x (205 SHIM2)
- Jet Shimmer 2x (280 SHIM2)
- Light Colorado Topaz Shimmer 2x (246 SHIM2)
- Scarlet Shimmer 2x (276 SHIM2)

5043 Briolette XXL Hole Bead

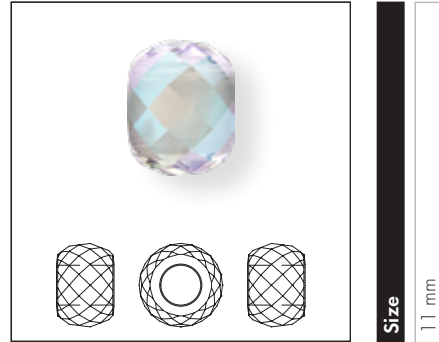

Size
11 mm

Crystal Effects

Transparent Effects

Crystal Shimmer 2x (001 SHIM2)

Color Effects

Transparent Effects

- Amethyst Shimmer 2x (204 SHIM2)
- Aquamarine Shimmer 2x (202 SHIM2)
- Emerald Shimmer 2x (205 SHIM2)
- Jet Shimmer 2x (280 SHIM2)
- Light Colorado Topaz Shimmer 2x (246 SHIM2)
- Scarlet Shimmer 2x (276 SHIM2)

5045 Rondelle Bead



Size
6 mm
8 mm

Crystal

Crystal (001)

Crystal Effects

Transparent Effects

- Crystal Aurore Boreale (001 AB)
- Crystal Silver Night (001 SINI)

5305 Slim XILION Bead

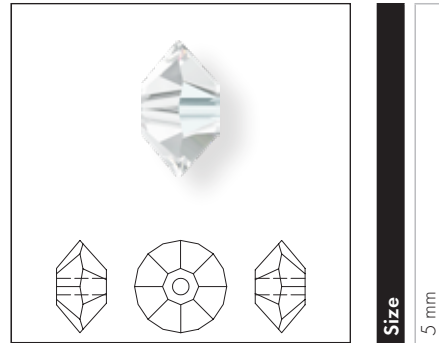

Size
5 mm
6 mm

Crystal

Crystal (001)

CORE ASSORTMENT

5328 XILION Bead



Size	2.5 mm	3 mm	4 mm	5 mm	6 mm	8 mm	10 mm
------	--------	------	------	------	------	------	-------

Crystal

Crystal (001)

Colors

Plain Colors

- Amethyst (204)
- Aquamarine (202)
- Black Diamond (215)
- Blue Zircon (229)
- Blush Rose (257)
- Capri Blue (243)
- Denim Blue (266)
- Emerald (205)
- Erinite (360)
- Fuchsia (502)
- Golden Topaz (1003)*
- Greige (284)
- Iris (219)
- Jet (280)
- Jonquil (213)
- Light Amber (1002)*
- Light Amethyst (212)
- Light Azore (361)
- Light Colorado Topaz (246)
- Light Peach (362)
- Light Rose (223)
- Light Sapphire (211)
- Light Siam (227)
- Light Silk (261)
- Light Topaz (226)
- Light Turquoise (263)
- Majestic Blue (296)
- Montana (207)
- Padparadscha (542)
- Peridot (214)
- Rose (209)

Crystal (001)	◆	◆	◆	◆	◆	◆	■
Amethyst (204)	◆	◆	◆	◆	◆	◆	
Aquamarine (202)	◆	◆	◆	◆	◆	◆	
Black Diamond (215)		■	■	■	■	■	
Blue Zircon (229)		■	■	■	■	■	
Blush Rose (257)		■	■	■	■	■	
Capri Blue (243)		■	■	■	■	■	
Denim Blue (266)		■	■	■	■	■	
Emerald (205)	◆	◆	◆	◆	◆	◆	
Erinite (360)		■	■	■	■	■	
Fuchsia (502)		■	■	■	■	■	
Golden Topaz (1003)*		■	■	■	■	■	
Greige (284)		■	■	■	■	■	
Iris (219)		■	■	■	■	■	
Jet (280)	◆	◆	◆	◆	◆	◆	
Jonquil (213)		■	■	■	■	■	
Light Amber (1002)*		■	■	■	■	■	
Light Amethyst (212)		■	■	■	■	■	
Light Azore (361)		■	■	■	■	■	
Light Colorado Topaz (246)	◆	◆	◆	◆	◆	◆	
Light Peach (362)		■	■	■	■	■	
Light Rose (223)	◆	◆	◆	◆	◆	◆	
Light Sapphire (211)		■	■	■	■	■	
Light Siam (227)		■	■	■	■	■	
Light Silk (261)		■	■	■	■	■	
Light Topaz (226)		■	■	■	■	■	
Light Turquoise (263)		■	■	■	■	■	
Majestic Blue (296)		■	■	■	■	■	
Montana (207)		■	■	■	■	■	
Padparadscha (542)		■	■	■	■	■	
Peridot (214)		■	■	■	■	■	
Rose (209)		■	■	■	■	■	

* All colors with a 4-digit color code (i.e. Golden Topaz) are fully customizable with shorter lead times and lower MOQs compared to our 3-digit colors. Please get in touch with the Customer Service for a time and quantity estimation of your desired variant.

◆ Core Assortment

	Size						
	2.5 mm	3 mm	4 mm	5 mm	6 mm	8 mm	10 mm
5328							
Ruby (501)		■	■	■	■		
Sapphire (206)		■	■	■	■	■	
Scarlet (276)	◆	◆	◆	◆	◆	◆	
Siam (208)		■	■	■	■	■	
Silk (391)		■	■	■	■		
Smoked Amber (1001)*		■	■	■	■		
Tanzanite (539)		■	■	■	■		
Topaz (203)		■	■	■	■		
Vintage Rose (319)		■	■	■	■		
Violet (371)		■	■	■	■		
Opal Colors							
White Opal (234)		■	■	■	■		
Crystal Effects							
Transparent Effects							
Crystal Antique Pink (001 ANTP)		■	■	■	■		
Crystal Aurore Boreale (001 AB)	■	■	■	■	■	■	■
Crystal Aurore Boreale 2x (001 AB2)		■	■	■	■		
Crystal Blue Shade (001 BLSH)		■	■	■	■		
Crystal Golden Shadow (001 GSHA)	■	■	■	■	■	■	
Crystal Moonlight (001 MOL)		■	■	■	■		
Crystal Paradise Shine (001 PARSH)		■	■	■	■		
Crystal Paradise Shine 2x (001 PARS2)			■				
Crystal Shimmer (001 SHIM)		■	■	■	■		
Crystal Shimmer 2x (001 SHIM2)		■	■				
Crystal Silver Night (001 SINI)		■	■	■	■	■	
Crystal Silver Shade (001 SSHA)	■	■	■	■	■	■	
Crystal Vitrail Medium (001 VM)		■	■				
Metallic Effects							
Crystal Comet Argent Light (001 CAL)		■	■	■	■		
Crystal Light Chrome (001 LTCH)		■	■	■	■		
Crystal Light Chrome 2x (001 LTCH2)			■				
Crystal Metallic Sunshine (001 METSH)		■	■	■	■		
Crystal Metallic Sunshine 2x (001 MTSH2)			■				
Crystal Rose Gold (001 ROGL)		■	■	■	■		
Crystal Rose Gold 2x (001 ROGL2)		■	■	■	■		

* All colors with a 4-digit color code (i.e. Golden Topaz) are fully customizable with shorter lead times and lower MOQs compared to our 3-digit colors. Please get in touch with the Customer Service for a time and quantity estimation of your desired variant.

◆ Core Assortment

5328	Size						
	2.5 mm	3 mm	4 mm	5 mm	6 mm	8 mm	10 mm
Color Effects							
Transparent Effects							
Amethyst Aurore Boreale (204 AB)		■	■				
Amethyst Shimmer (204 SHIM)		■	■	■	■		
Amethyst Shimmer 2x (204 SHIM2)		■	■				
Aquamarine Aurore Boreale (202 AB)		■	■				
Aquamarine Shimmer (202 SHIM)		■	■	■	■		
Aquamarine Shimmer 2x (202 SHIM2)		■	■				
Black Diamond Shimmer (215 SHIM)		■	■	■	■		
Black Diamond Shimmer 2x (215 SHIM2)		■	■				
Capri Blue Aurore Boreale (243 AB)		■	■				
Chrysolite Opal Shimmer (294 SHIM)		■	■	■	■		
Chrysolite Opal Shimmer 2x (294 SHIM2)		■	■				
Cyclamen Opal Shimmer (398 SHIM)		■	■	■	■		
Cyclamen Opal Shimmer 2x (398 SHIM2)		■	■				
Iris Aurore Boreale (219 AB)		■	■	■	■		
Iris Aurore Boreale 2x (219 AB2)		■	■				
Jet Aurore Boreale (280 AB)		■	■	■	■		
Jet Aurore Boreale 2x (280 AB2)		■	■				
Light Amethyst Shimmer (212 SHIM)		■	■	■	■		
Light Amethyst Shimmer 2x (212 SHIM2)		■	■				
Light Rose Aurore Boreale (223 AB)		■	■	■	■		
Light Rose Aurore Boreale 2x (223 AB2)		■	■				
Light Rose Shimmer (223 SHIM)		■	■	■	■		
Light Rose Shimmer 2x (223 SHIM2)		■	■				
Light Sapphire Aurore Boreale (211 AB)		■	■				
Light Sapphire Shimmer 2x (211 SHIM2)		■	■				
Light Siam Aurore Boreale (227 AB)		■	■				
Light Siam Shimmer 2x (227 SHIM2)		■	■				
Pacific Opal Shimmer (390 SHIM)		■	■	■	■		
Pacific Opal Shimmer 2x (390 SHIM2)		■	■				
Peridot Aurore Boreale (214 AB)			■				
Peridot Shimmer (214 SHIM)		■	■	■	■		
Peridot Shimmer 2x (214 SHIM2)		■	■				
Rose Aurore Boreale (209 AB)		■	■				

	5328							
	Size	2.5 mm	3 mm	4 mm	5 mm	6 mm	8 mm	10 mm
Rose Shimmer (209 SHIM)			■	■	■	■		
Rose Shimmer 2x (209 SHIM2)			■	■				
Rose Water Opal Shimmer (395 SHIM)			■	■	■	■		
Rose Water Opal Shimmer 2x (395 SHIM2)			■	■				
Sapphire Aurore Boreale (206 AB)			■	■				
Siam Shimmer (208 SHIM)			■	■	■	■		
Siam Shimmer 2x (208 SHIM2)			■	■				
Violet Aurore Boreale (371 AB)			■	■				
White Opal Shimmer (234 SHIM)			■	■	■	■		
White Opal Shimmer 2x (234 SHIM2)			■	■				
Yellow Opal Shimmer (231 SHIM)			■	■	■	■		
Yellow Opal Shimmer 2x (231 SHIM2)			■	■				
Metallic Effects								
Jet Hematite (280 HEM)			■	■				
Jet Hematite 2x (280 HEM2)			■	■				

5500 Drop Bead



Size

9x6 mm

12x8 mm

Crystal

Crystal (001)

Colors

Plain Colors

Amethyst (204)

Aquamarine (202)

Jet (280)

Light Colorado Topaz (246)

Light Rose (223)

Light Siam (227)

Siam (208)

Crystal Effects

Transparent Effects

Crystal Aurore Boreale (001 AB)

Crystal Shimmer 2x (001 SHIM2)

Color Effects

Transparent Effects

Amethyst Shimmer 2x (204 SHIM2)

Aquamarine Shimmer 2x (202 SHIM2)

Light Colorado Topaz Shimmer 2x (246 SHIM2)

Light Siam Shimmer 2x (227 SHIM2)

5542 Dome Bead small



Size

8 mm

Crystal

Crystal (001)

Crystal Effects

Transparent Effects

Crystal Aurore Boreale (001 AB)

Crystal Golden Shadow (001 GSHA)

5601 Cube Bead

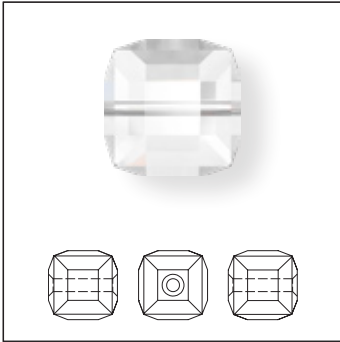

Size	4 mm	6 mm	8 mm	10 mm	12 mm
------	------	------	------	-------	-------

Crystal

Crystal (001)

Colors

Plain Colors

- Amethyst (204)
- Aquamarine (202)
- Black Diamond (215)
- Blush Rose (257)
- Emerald (205)
- Erinite (360)
- Fuchsia (502)
- Iris (219)
- Jet (280)
- Light Colorado Topaz (246)
- Light Sapphire (211)
- Light Siam (227)
- Light Topaz (226)
- Light Turquoise (263)
- Majestic Blue (296)
- Peridot (214)
- Sapphire (206)
- Siam (208)
- Tanzanite (539)
- Topaz (203)

Crystal Effects

Transparent Effects

- Crystal Aurore Boreale B (001 ABB)
- Crystal Blue Shade B (001 BLSB)
- Crystal Golden Shadow B (001 GSHAB)
- Crystal Shimmer B (001 SHIMB)
- Crystal Silver Night B (001 SINIB)
- Crystal Vitrail Medium B (001 VMB)

Metallic Effects

- Crystal Light Chrome B (001 LTCHB)
- Crystal Metallic Sunshine B (001 MTSHB)
- Crystal Rose Gold B 2x (001 ROGB2)

Crystal (001)	■	■	■	■	■
Amethyst (204)	■	■	■		
Aquamarine (202)	■	■	■		
Black Diamond (215)	■	■	■		
Blush Rose (257)	■	■	■		
Emerald (205)	■	■	■		
Erinite (360)	■	■	■		
Fuchsia (502)	■	■	■		
Iris (219)	■	■	■		
Jet (280)	■	■	■		
Light Colorado Topaz (246)	■	■	■		
Light Sapphire (211)	■	■	■		
Light Siam (227)	■	■	■		
Light Topaz (226)		■	■		
Light Turquoise (263)	■	■	■		
Majestic Blue (296)	■	■	■		
Peridot (214)	■	■	■		
Sapphire (206)	■	■	■		
Siam (208)	■	■	■		
Tanzanite (539)	■	■	■		
Topaz (203)	■	■	■		
Crystal Aurore Boreale B (001 ABB)	■	■	■	■	■
Crystal Blue Shade B (001 BLSB)	■	■	■		
Crystal Golden Shadow B (001 GSHAB)	■	■	■		
Crystal Shimmer B (001 SHIMB)	■	■	■		
Crystal Silver Night B (001 SINIB)	■	■	■		
Crystal Vitrail Medium B (001 VMB)	■	■	■		
Crystal Light Chrome B (001 LTCHB)	■	■	■		
Crystal Metallic Sunshine B (001 MTSHB)	■	■	■		
Crystal Rose Gold B 2x (001 ROGB2)	■	■			

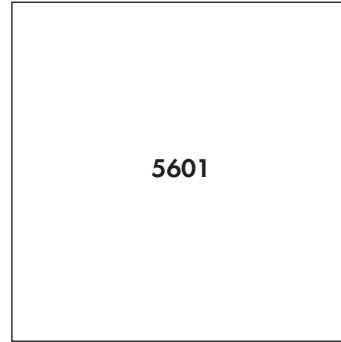

Size	4 mm	6 mm	8 mm	10 mm	12 mm
------	------	------	------	-------	-------

Color Effects

Transparent Effects

- Black Diamond Shimmer B (215 SHIMB)
- Chrysolite Opal Shimmer B (294 SHIMB)
- Erinite Shimmer B (360 SHIMB)
- Light Colorado Topaz Shimmer B (246 SHIMB)
- Light Sapphire Shimmer B (211 SHIMB)
- Light Siam Shimmer B (227 SHIMB)
- Pacific Opal Shimmer B (390 SHIMB)
- Rose Water Opal Shimmer B (395 SHIMB)
- White Opal Shimmer B (234 SHIMB)

Black Diamond Shimmer B (215 SHIMB)	■	■	■		
Chrysolite Opal Shimmer B (294 SHIMB)	■	■	■		
Erinite Shimmer B (360 SHIMB)	■	■	■		
Light Colorado Topaz Shimmer B (246 SHIMB)	■	■	■		
Light Sapphire Shimmer B (211 SHIMB)	■	■	■		
Light Siam Shimmer B (227 SHIMB)	■	■	■		
Pacific Opal Shimmer B (390 SHIMB)	■	■			
Rose Water Opal Shimmer B (395 SHIMB)	■	■			
White Opal Shimmer B (234 SHIMB)	■	■			

5714 Star Bead

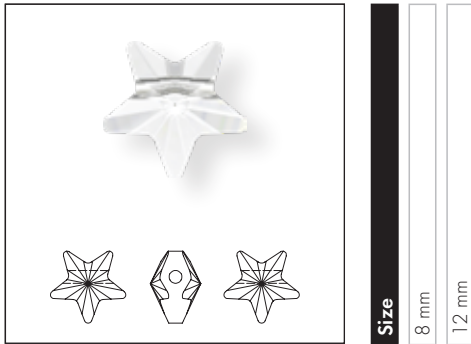

Size
8 mm
12 mm

Crystal

Crystal (001)

Crystal Effects

Transparent Effects

Crystal Aurore Boreale (001 AB)

5741 Love Bead

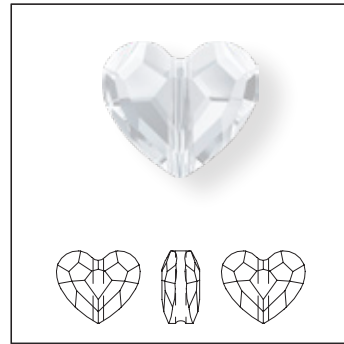

Size
8 mm
12 mm

Crystal

Crystal (001)

Colors

Plain Colors

Blush Rose (257)

Light Siam (227)

Crystal Effects

Transparent Effects

Crystal Aurore Boreale (001 AB)

Crystal Silver Night 2x (001 SINI2)

5742 Heart Bead

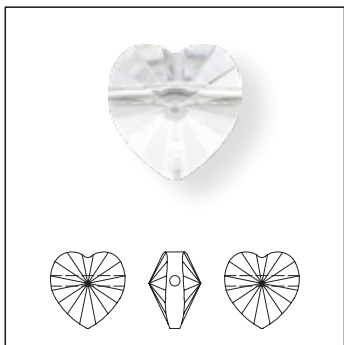

Size
8 mm
10 mm

Crystal

Crystal (001)

Crystal Effects

Transparent Effects

Crystal Aurore Boreale (001 AB)

5750 Skull Bead



Size
13 mm
19 mm

Crystal

Crystal (001)

Colors

Plain Colors

Jet (280)

Crystal Effects

Transparent Effects

Crystal Silver Night (001 SINI)

Crystal Silver Night 2x (001 SINI2)

5752 Clover Bead

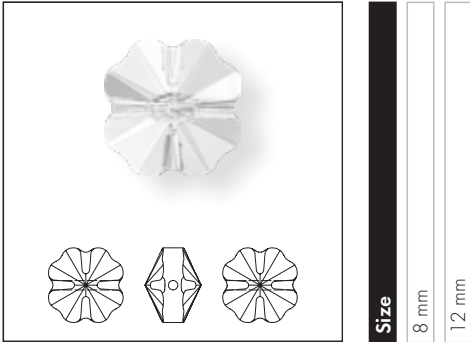

Size
8 mm
12 mm

Crystal

Crystal (001)

Crystal Effects

Transparent Effects

Crystal Aurore Boreale (001 AB)

Crystal Golden Shadow (001 GSHA)

5754 Butterfly Bead

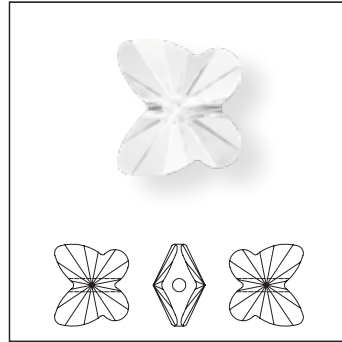

Size
6 mm
8 mm
10 mm

Crystal

Crystal (001)

Colors

Plain Colors

Jet (280)

Light Rose (223)

Light Siam (227)

Crystal Effects

Transparent Effects

Crystal Aurore Boreale (001 AB)

Crystal Golden Shadow (001 GSHA)

Product Details

Article Size	Packing Unit = Minimum Order Quantity in Pieces	Average Net Weight in Gram per Packing Unit Crystal (001)	Average Gross Weight in Gram per Packing Unit Crystal (001)
5000			
2 mm	1,440	11.5	20.8
3 mm	720	23.6	33.4
4 mm	720	53.5	62.6
5 mm	720	105.3	116.3
6 mm	360	81.6	92.5
8 mm	288	193.5	200.8
10 mm	144	180.6	199.4
12 mm	72	144.2	166.1
5003			
6 mm	360	109.9	120.8
8 mm	144	100.4	118.6
10 mm	144	195.9	219.2
12 mm	72	158.5	179.2
5020			
6 mm	360	74.5	85.2
8 mm	288	146.6	178.2
10 mm	144	116.4	139.2
5028/4			
6 mm	360	75.791	83.4
8 mm	144	74.714	85.6
10 mm	72	70.763	76.5
5040			
4 mm	720	41.3	50.4
6 mm	360	71.8	82.9
8 mm	288	135.6	163.7
12 mm	144	214.4	242.4
5042			
6 mm	288	45.7	69.3
8 mm	216	93.4	120.2
5043			
11 mm	12	13.2	31.8
5045			
6 mm	288	60.7	70.9
8 mm	216	117.5	145.9
5305			
5 mm	720	52.7	63.9
6 mm	360	50.5	61.4
5328			
2.5 mm	1,440	23.8	31.4
3 mm	1,440	34.1	45.2
4 mm	1,440	81.8	89.2
5 mm	720	89.3	100.0
6 mm	360	73.7	84.6
8 mm	288	141.8	173.4
10 mm	144	140.4	154.0

Article Size	Packing Unit = Minimum Order Quantity in Pieces	Average Net Weight in Gram per Packing Unit Crystal (001)	Average Gross Weight in Gram per Packing Unit Crystal (001)
5500			
9x6 mm	144	59.0	69.9
12x8 mm	144	144.0	164.1
5542			
8 mm	96	81.4	102.9
5601			
4 mm	288	43.9	65.2
6 mm	144	70.6	88.9
8 mm	96	100.2	118.4
10 mm	72	138.0	156.5
12 mm	36	129.6	147.7
5714			
8 mm	288	73.3	102.1
12 mm	108	72.3	102.2
5741			
8 mm	144	43.3	66.24
12 mm	72	66.2	89.58
5742			
8 mm	288	120.5	154.5
10 mm	288	233.1	266.5
5750			
13 mm	12	24.2	43.8
19 mm	12	73.7	100.0
5752			
8 mm	288	106.1	136.9
12 mm	96	117.7	137.5
5754			
6 mm	360	42.3	53.0
8 mm	288	77.9	109.8
10 mm	288	156.9	188.9