



























Fancy Stones







Fancy Stones are available in numerous shapes, ranging from classical gemstone inspired cuts to progressive trend cuts. They come in a huge assortment of different sizes and colors. Showing either a faceted or flat reverse side, Fancy Stones can be glued into pre cast cavities or used in metal settings. Their precision cut facets ensure the highest brilliance and lend design ideas a unique sparkle.

Colors & Effects













Colors

-  Crystal 001
-  White Opal 234
-  Silk 391
-  Vintage Rose 319
-  Light Rose 223
-  Rose 209
-  Light Siam 227
-  Scarlet 276
-  Siam 208
-  Amethyst 204
-  Iris 219
-  Light Amethyst 212
-  Tanzanite 539
-  Light Sapphire 211
-  Aquamarine 202
-  Sapphire 206
-  Majestic Blue¹ 296
-  Montana 207
-  Black Diamond 215
-  Peridot 214
-  Emerald 205
-  Light Colorado Topaz 246
-  Light Topaz 226
-  Golden Topaz 1003
-  Light Amber 1002
-  Smoked Amber 1001
-  Jet 280







Effects

-  Crystal Silver Shade 001 SSHA
-  Crystal Aurore Boreale 001 AB
-  Crystal Golden Shadow 001 GSHA
-  Crystal Paradise Shine* 001 PARSH
-  Crystal Vitrail Medium** 001 VM
-  Crystal Silver Night** 001 SINI
-  Jet Hematite* 280 HEM

Crystal Lacquer^{Pro} Effects

-  Crystal Lacquer^{Pro} DeLite Effects
-  Crystal Ivory Cream DeLite* 001 L106D
-  Crystal Orange Glow DeLite* 001 L146D
-  Crystal Lotus Pink DeLite* 001 L145D
-  Crystal Royal Red DeLite* 001 L107D
-  Crystal Dusty Pink DeLite* 001 L149D
-  Crystal Lavender DeLite* 001 L144D
-  Crystal Ocean DeLite* 001 L143D
-  Crystal Royal Blue DeLite* 001 L110D
-  Crystal Laguna DeLite* 001 L142D
-  Crystal Silky Sage DeLite* 001 L147D
-  Crystal Serene Gray DeLite* 001 L150D

Ignite Effects

-  Crystal Ignite 001 IGNIT
-  Light Rose Ignite 223 IGNIT
-  Scarlet Ignite 276 IGNIT
-  Amethyst Ignite 204 IGNIT
-  Aquamarine Ignite 202 IGNIT
-  Emerald Ignite 205 IGNIT
-  Light Colorado Topaz Ignite 246 IGNIT

Shimmer Effects

-  Light Topaz Shimmer 226 SHIM

Numerical Order

001	Crystal
001 AB	Crystal Aurore Boreale
001 GSHA	Crystal Golden Shadow
001 IGNIT	Crystal Ignite
001 LI06D	Crystal Ivory Cream DeLite*
001 LI07D	Crystal Royal Red DeLite*
001 LI10D	Crystal Royal Blue DeLite*
001 LI42D	Crystal Laguna DeLite*
001 LI43D	Crystal Ocean DeLite*
001 LI44D	Crystal Lavender DeLite*
001 LI45D	Crystal Lotus Pink DeLite*
001 LI46D	Crystal Orange Glow DeLite*
001 LI47D	Crystal Silky Sage DeLite*
001 LI49D	Crystal Dusty Pink DeLite*
001 LI50D	Crystal Serene Gray DeLite*
001 PARSH	Crystal Paradise Shine*
001 SINI	Crystal Silver Night**
001 SSHA	Crystal Silver Shade
001 VM	Crystal Vitrail Medium**
202	Aquamarine
202 IGNIT	Aquamarine Ignite
204	Amethyst
204 IGNIT	Amethyst Ignite
205	Emerald
205 IGNIT	Emerald Ignite
206	Sapphire
207	Montana
208	Siam
209	Rose
211	Light Sapphire
212	Light Amethyst
214	Peridot
215	Black Diamond
219	Iris
223	Light Rose
223 IGNIT	Light Rose Ignite
226	Light Topaz
226 SHIM	Light Topaz Shimmer
227	Light Siam
234	White Opal
246	Light Colorado Topaz
246 IGNIT	Light Colorado Topaz Ignite
276	Scarlet
276 IGNIT	Scarlet Ignite
280	Jet
280 HEM	Jet Hematite*
296	Majestic Blue ¹
319	Vintage Rose
391	Silk
539	Tanzanite
1001	Smoked Amber
1002	Light Amber
1003	Golden Topaz

For details on available colors and effects for each article within the product groups, please see the product matrix of the respective item in the Collection 2021. For color and effect samples, please see the corresponding color chart.

The plating resistance of effects is tested according to Swarovski's plating guidelines (SWAROVSKI.COM/S-PROFESSIONALS). Customers are advised to carry out their own tests if their plating parameters diverge from Swarovski plating guidelines.

* Crystals are not resistant to plating and similar processing.

** Crystals are resistant to plating only if they are F-foiled.

¹ Majestic Blue's intense ultramarine hue is difficult to recreate accurately in print due to the fact that the CMYK color spectrum is used in the printing process. In order to get a truer impression of its color, please use RGB digital pictures or, ideally, ask for actual samples.

Alphabetical Order

Amethyst (204)
<u>Amethyst Ignite (204 IGNIT)</u>
Aquamarine (202)
<u>Aquamarine Ignite (202 IGNIT)</u>
Black Diamond (215)
Crystal (001)
Crystal Aurore Boreale (001 AB)
<u>Crystal Dusty Pink DeLite (001 LI49D)*</u>
<u>Crystal Golden Shadow (001 GSHA)</u>
<u>Crystal Ignite (001 IGNIT)</u>
<u>Crystal Ivory Cream DeLite (001 LI06D)*</u>
<u>Crystal Laguna DeLite (001 LI42D)*</u>
<u>Crystal Lavender DeLite (001 LI44D)*</u>
<u>Crystal Lotus Pink DeLite (001 LI45D)*</u>
<u>Crystal Ocean DeLite (001 LI43D)*</u>
<u>Crystal Orange Glow DeLite (001 LI46D)*</u>
<u>Crystal Paradise Shine (001 PARSH)*</u>
<u>Crystal Royal Blue DeLite (001 LI10D)*</u>
<u>Crystal Royal Red DeLite (001 LI07D)*</u>
<u>Crystal Serene Gray DeLite (001 LI50D)*</u>
<u>Crystal Silky Sage DeLite (001 LI47D)*</u>
<u>Crystal Silver Night (001 SINI)**</u>
<u>Crystal Silver Shade (001 SSHA)</u>
<u>Crystal Vitrail Medium (001 VM)**</u>
Emerald (205)
<u>Emerald Ignite (205 IGNIT)</u>
<u>Golden Topaz (1003)</u>
<u>Iris (219)</u>
Jet (280)
<u>Jet Hematite (280 HEM)*</u>
<u>Light Amber (1002)</u>
<u>Light Amethyst (212)</u>
<u>Light Colorado Topaz (246)</u>
<u>Light Colorado Topaz Ignite (246 IGNIT)</u>
<u>Light Rose (223)</u>
<u>Light Rose Ignite (223 IGNIT)</u>
<u>Light Sapphire (211)</u>
<u>Light Siam (227)</u>
<u>Light Topaz (226)</u>
<u>Light Topaz Shimmer (226 SHIM)</u>
<u>Majestic Blue (296)¹</u>
Montana (207)
Peridot (214)
Rose (209)
Sapphire (206)
<u>Scarlet (276)</u>
<u>Scarlet Ignite (276 IGNIT)</u>
Siam (208)
Silk (391)
<u>Smoked Amber (1001)</u>
Tanzanite (539)
<u>Vintage Rose (319)</u>
<u>White Opal (234)</u>

Classic Colors/Effects: This color range offers a wide choice of traditional Swarovski crystal colors and effects.

Exclusive Colors/Effects: This color range is offered exclusively by Swarovski.

Colors and effects can appear different when illuminated with different light sources. Swarovski uses standard light source D50 for color decision and comparison. Slight changes in shades are unavoidable. Colors may vary according to cut and foiling.

The composition of Advanced Crystal is compliant with regulatory industry norms and laws regarding the restriction or prohibition of certain substances in the most relevant segments of our customers. Please note that the compliance of the crystal colors Light Siam and Siam varies according to certain industry regulations. Those regulations are indicated with * in the compliance overview. Scarlet (option to Lt. Siam) conform to all CLEAR-lists. For further information please visit swarovski.com/s-professionals

Summary

1 2 3

CORE ASSORTMENT
4120
 6x4, 8x6, 14x10,
 18x13 mm

1 2 3

4122
 8x6, 14x10.5,
 18x13.5 mm

1 2 3

4127
 30x22 mm

1 2 3

4128
 6x4, 8x6 mm

1 2 3

4160
 8x6, 10x8, 14x10,
 18x13 mm

1 2 3

4161
 15x5 mm

1 2 3

4162
 10x5.5, 14x7.5,
 18x9.5 mm

1 2 3

CORE ASSORTMENT
4228
 4x2, 5x2.5,
 6x3, 8x4, 10x5,
 15x7 mm

1 2 3

CORE ASSORTMENT
4320
 6x4, 8x6, 10x7,
 14x10, 18x13 mm

1 2 3

4322
 10x5 mm

1 2 3

4327
 30x20 mm

1 2 3

4328
 6x3.6, 8x4.8 mm

1 2 3

CORE ASSORTMENT
4428
 1.5, 2, 3, 4, 8 mm

1 2 3

4447
 6, 8, 10, 12 mm

1 2 3

4460
 8, 10, 14, 18 mm

1 2 3

CORE ASSORTMENT
4470
 10, 12 mm

1 2 3

4471
 8, 10, 12 mm

1 2 3

4480
 6, 8, 10, 14, 18 mm

1 2 3

4483
 8, 10, 12, 14 mm

1 2 3

4499
 6, 10, 14, 20 mm

1 2 3

4500
 3x2, 6x2 mm

1 2 3

CORE ASSORTMENT
4501
 4x2, 5x2, 5x2.5,
 7x3 mm

1 2 3

4502
 3x1 mm

1 2 3

4547
 15x5, 21x7 mm

1 2 3

4568
 14x10, 18x13 mm

1 2 3

4595
 8x4, 12x6, 16x8,
 20x10 mm

1 2 3

4600
 10x8 mm

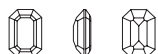
1 2 3

4610
 14x10, 18x13 mm

1 2 3

4627
 27x18.5 mm

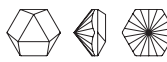
1 2 3

4683
 7.8x8.7, 10x11.2,
 12x13.5,
 14x15.8 mm

1 2 3

4699
 6x6.9,
 9.4x10.8, 14x16,
 20x22.9 mm

1 2 3

4706
 7, 12, 17 mm

1 2 3

4722
 4, 6 mm

1 2 3

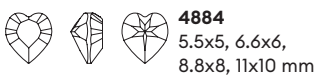
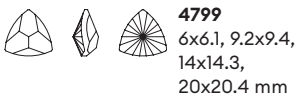

Summary

CORE ASSORTMENT

4120 Oval Fancy Stone



Crystal	6x4 mm	8x6 mm	14x10 mm	18x13 mm
Crystal F (001)	◆	◆	◆	◆
Colors				
Plain Colors				
Amethyst F (204)	◆	◆	◆	◆
Aquamarine F (202)	◆	◆	◆	◆
Black Diamond F (215)			■	■
Emerald F (205)	◆	◆	◆	◆
Golden Topaz F (1003)*	■	■	■	■
Iris F (219)	■	■	■	■
Jet (280)	◆	◆	◆	◆
Light Amber F (1002)*	■	■	■	■
Light Amethyst F (212)	■	■	■	■
Light Colorado Topaz F (246)	◆	◆	◆	◆
Light Rose F (223)	◆	◆	◆	◆
Montana F (207)		■	■	■
Rose F (209)	■	■	■	■
Sapphire F (206)	■	■	■	■
Scarlet F (276)	◆	◆	◆	◆
Siam F (208)	■	■	■	■
Smoked Amber F (1001)*	■	■	■	■
Tanzanite F (539)	■	■	■	■
Vintage Rose F (319)	■	■	■	■
Opal Colors				
White Opal F (234)		■	■	■
Crystal Effects				
Transparent Effects				
Crystal Aureore Boreale F (001 AB)		■	■	■
Crystal Golden Shadow F (001 GSHA)		■	■	■
Crystal Ignite (001 IGNIT)		■	■	■
Crystal Silver Night F (001 SINI)		■	■	■
Crystal Silver Shade F (001 SSHA)		■	■	■

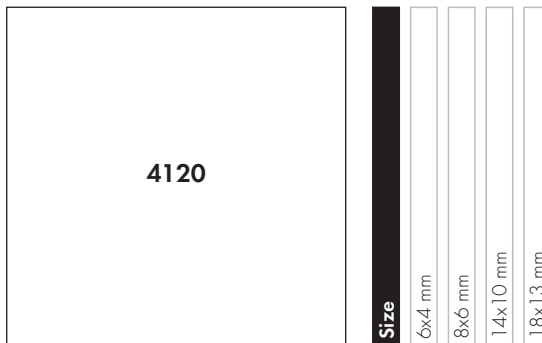

Crystal Lacquer ^{PRO} Effects	6x4 mm	8x6 mm	14x10 mm	18x13 mm
Crystal Lacquer^{PRO} DeLite Effects				
Crystal Dusty Pink DeLite (001 L149D)			■	■
Crystal Ivory Cream DeLite (001 L106D)			■	■
Crystal Laguna DeLite (001 L142D)			■	■
Crystal Lavender DeLite (001 L144D)			■	■
Crystal Lotus Pink DeLite (001 L145D)			■	■
Crystal Ocean DeLite (001 L143D)			■	■
Crystal Orange Glow DeLite (001 L146D)			■	■
Crystal Royal Blue DeLite (001 L110D)			■	■
Crystal Royal Red DeLite (001 L107D)			■	■
Crystal Serene Gray DeLite (001 L150D)			■	■
Crystal Silky Sage DeLite (001 L147D)			■	■
Color Effects				
Transparent Effects				
Amethyst Ignite (204 IGNIT)		■	■	■
Aquamarine Ignite (202 IGNIT)		■	■	■
Emerald Ignite (205 IGNIT)		■	■	■
Light Colorado Topaz Ignite (246 IGNIT)		■	■	■
Light Rose Ignite (223 IGNIT)		■	■	■
Scarlet Ignite (276 IGNIT)		■	■	■

02

* All colors with a 4-digit color code (i.e. Golden Topaz) are fully customizable with shorter lead times and lower MOQs compared to our 3-digit colors. Please get in touch with the Customer Service for a time and quantity estimation of your desired variant.

◆ Core Assortment

4122 Oval Rivoli Fancy Stone

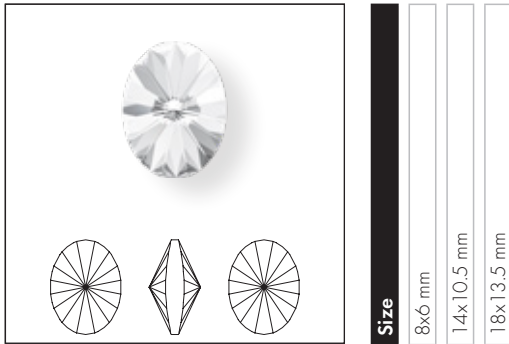

Size

8x6 mm

14x 10.5 mm

18x 13.5 mm

Crystal Effects

Crystal Lacquer^{PRO} Effects

Crystal Lacquer^{PRO} DeLite Effects

- Crystal Dusty Pink DeLite (001 L149D)
- Crystal Ivory Cream DeLite (001 L106D)
- Crystal Serene Gray DeLite (001 L150D)

4127 Big Oval Fancy Stone

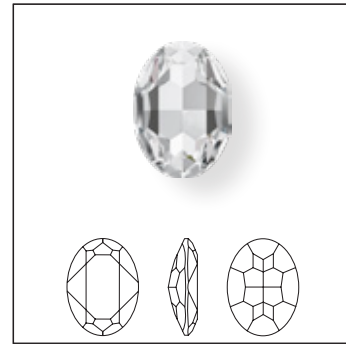

Size

30x22 mm

Crystal

- Crystal F (001)

Colors

Plain Colors

- Amethyst F (204)
- Aquamarine F (202)
- Black Diamond F (215)
- Jet (280)
- Light Colorado Topaz F (246)
- Light Rose F (223)
- Montana F (207)
- Tanzanite F (539)

Opal Colors

- White Opal F (234)

Crystal Effects

Transparent Effects

- Crystal Aurore Boreale F (001 AB)
- Crystal Golden Shadow F (001 GSHA)
- Crystal Silver Shade F (001 SSHA)

Crystal Lacquer^{PRO} Effects

Crystal Lacquer^{PRO} DeLite Effects

- Crystal Dusty Pink DeLite (001 L149D)
- Crystal Ivory Cream DeLite (001 L106D)
- Crystal Laguna DeLite (001 L142D)
- Crystal Lavender DeLite (001 L144D)
- Crystal Lotus Pink DeLite (001 L145D)
- Crystal Ocean DeLite (001 L143D)
- Crystal Orange Glow DeLite (001 L146D)
- Crystal Royal Blue DeLite (001 L110D)
- Crystal Royal Red DeLite (001 L107D)
- Crystal Serene Gray DeLite (001 L150D)
- Crystal Silky Sage DeLite (001 L147D)

4128 XILION Oval Fancy Stone



Size
6x4 mm
8x6 mm

Crystal	
Crystal F (001)	<input type="checkbox"/>
Colors	
Plain Colors	
Amethyst F (204)	<input type="checkbox"/>
Aquamarine F (202)	<input type="checkbox"/>
Black Diamond F (215)	<input type="checkbox"/>
Emerald F (205)	<input type="checkbox"/>
Light Amethyst F (212)	<input type="checkbox"/>
Light Rose F (223)	<input type="checkbox"/>
Montana F (207)	<input type="checkbox"/>
Rose F (209)	<input type="checkbox"/>
Scarlet F (276)	<input type="checkbox"/>
Siam F (208)	<input type="checkbox"/>
Crystal Effects	
Transparent Effects	
Crystal Golden Shadow F (001 GSHA)	<input type="checkbox"/>

4160 Mystic Oval Fancy Stone

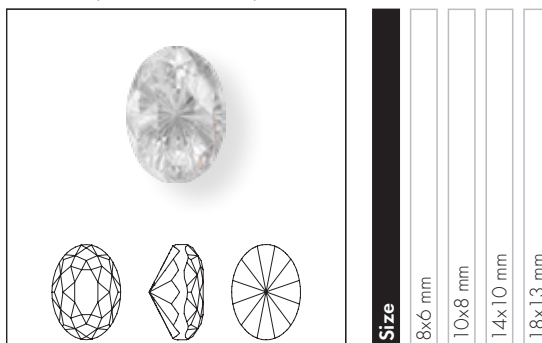

Size
8x6 mm
10x8 mm
14x10 mm
18x13 mm

Crystal	
Crystal F (001)	<input type="checkbox"/>
Colors	
Plain Colors	
Amethyst F (204)	<input type="checkbox"/>
Aquamarine F (202)	<input type="checkbox"/>
Emerald F (205)	<input type="checkbox"/>
Iris F (219)	<input type="checkbox"/>
Light Colorado Topaz F (246)	<input type="checkbox"/>
Scarlet F (276)	<input type="checkbox"/>
Crystal Effects	
Transparent Effects	
Crystal Astral Pink F (001 API)	<input type="checkbox"/>
Crystal Aurore Boreale F (001 AB)	<input type="checkbox"/>
Crystal Luminous Green F (001 LUMG)	<input type="checkbox"/>
Crystal Paradise Shine F (001 PARSH)	<input type="checkbox"/>
Crystal Vitrail Medium F (001 VM)	<input type="checkbox"/>
Color Effects	
Transparent Effects	
Light Topaz Shimmer F (226 SHIM)	<input type="checkbox"/>

4161 Long Classic Oval Fancy Stone

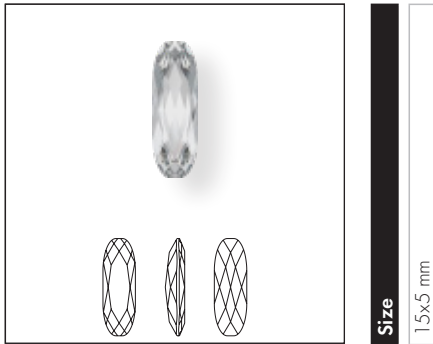

Size

15x5 mm

Crystal

Crystal F (001)

4162 Elongated Oval Fancy Stone

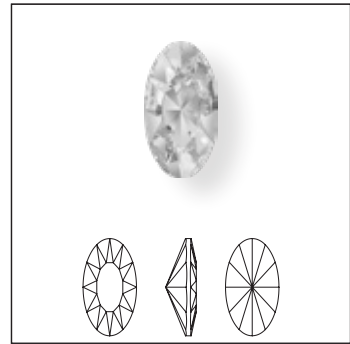

Size

10x5.5 mm

14x7.5 mm

18x9.5 mm

Crystal

Crystal F (001)

Colors

Plain Colors

Amethyst F (204)

Aquamarine F (202)

Emerald F (205)

Iris F (219)

Jet (280)

Light Colorado Topaz F (246)

Majestic Blue F (296)

Montana F (207)

Scarlet F (276)

Vintage Rose F (319)

Crystal Effects

Transparent Effects

Crystal Aurore Boreale F (001 AB)

Crystal Golden Shadow F (001 GSHA)

Crystal Silver Shade F (001 SSHA)

CORE ASSORTMENT

4228 XILION Navette Fancy Stone



Size 4x2, 5x2.5 mm

4228 XILION Navette Fancy Stone



















Size 6x3, 8x4, 10x5, 15x7 mm

4228	Size					
	4x2 mm	5x2.5 mm	6x3 mm	8x4 mm	10x5 mm	15x7 mm
Crystal						
Crystal F (001)	◆	◆	◆	◆	◆	◆
Colors						
Plain Colors						
Amethyst F (204)	◆	◆	◆	◆	◆	◆
Aquamarine F (202)	◆	◆	◆	◆	◆	◆
Black Diamond F (215)	■	■	■	■	■	■
Emerald F (205)	◆	◆	◆	◆	◆	◆
Golden Topaz F (1003)*	■	■	■	■	■	■
Iris F (219)			■	■	■	■
Jet (280)	◆	◆	◆	◆	◆	◆
Light Amber F (1002)*	■	■	■	■	■	■
Light Amethyst F (212)	■	■	■	■	■	■
Light Colorado Topaz F (246)	◆	◆	◆	◆	◆	◆
Light Rose F (223)	◆	◆	◆	◆	◆	◆
Light Sapphire F (211)	■	■	■	■	■	■
Light Siam F (227)	■	■	■	■	■	■
Light Topaz F (226)			■	■	■	■
Montana F (207)	■		■	■	■	■
Peridot F (214)	■		■	■	■	■
Rose F (209)	■		■	■	■	■
Sapphire F (206)			■	■	■	■
Scarlet F (276)	◆	◆	◆	◆	◆	◆
Siam F (208)	■		■	■	■	■
Smoked Amber F (1001)*	■	■	■	■	■	■
Tanzanite F (539)	■		■	■	■	■
Opal Colors						
White Opal F (234)	■		■	■	■	■
Crystal Effects						
Transparent Effects						
Crystal Aurore Boreale F (001 AB)	■		■	■	■	■
Crystal Golden Shadow F (001 GSHA)	■	■	■	■	■	■
Crystal Ignite (001 IGNIT)			■	■	■	■
Crystal Silver Night F (001 SINI)	■		■	■	■	■
Crystal Silver Shade F (001 SSHA)	■	■	■	■	■	■

* All colors with a 4-digit color code (i.e. Golden Topaz) are fully customizable with shorter lead times and lower MOQs compared to our 3-digit colors. Please get in touch with the Customer Service for a time and quantity estimation of your desired variant.

◆ Core Assortment

4228		Size	4x2 mm	5x2.5 mm	6x3 mm	8x4 mm	10x5 mm	15x7 mm
Crystal Lacquer^{PRO} Effects								
Crystal Lacquer^{PRO} DeLite Effects								
 Crystal Dusty Pink DeLite (001 L149D)							■	
 Crystal Ivory Cream DeLite (001 L106D)							■	
 Crystal Laguna DeLite (001 L142D)							■	
 Crystal Lavender DeLite (001 L144D)							■	
 Crystal Lotus Pink DeLite (001 L145D)							■	
 Crystal Ocean DeLite (001 L143D)							■	
 Crystal Orange Glow DeLite (001 L146D)							■	
 Crystal Royal Blue DeLite (001 L110D)							■	
 Crystal Royal Red DeLite (001 L107D)							■	
 Crystal Serene Gray DeLite (001 L150D)							■	
 Crystal Silky Sage DeLite (001 L147D)							■	
Color Effects								
Transparent Effects								
 Amethyst Ignite (204 IGNIT)				■	■	■	■	
 Aquamarine Ignite (202 IGNIT)				■	■	■	■	
 Emerald Ignite (205 IGNIT)				■	■	■	■	
 Light Colorado Topaz Ignite (246 IGNIT)				■	■	■	■	
 Light Rose Ignite (223 IGNIT)				■	■	■	■	
 Scarlet Ignite (276 IGNIT)				■	■	■	■	

CORE ASSORTMENT

4320 Pear Fancy Stone

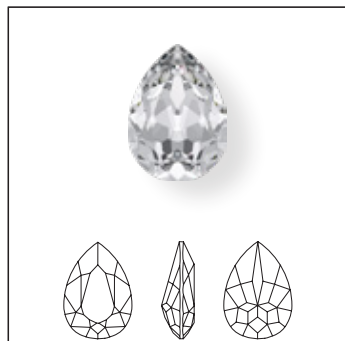

Size	6x4 mm	8x6 mm	10x7 mm	14x10 mm	18x13 mm
------	--------	--------	---------	----------	----------

Crystal

Crystal F (001)

Colors

Plain Colors

Amethyst F (204)

Aquamarine F (202)

Black Diamond F (215)

Emerald F (205)

Golden Topaz F (1003)*

Iris F (219)

Jet (280)

Light Amber F (1002)*

Light Colorado Topaz F (246)

Light Rose F (223)

Montana F (207)

Rose F (209)

Scarlet F (276)

Siam F (208)

Smoked Amber F (1001)*

Tanzanite F (539)

Vintage Rose F (319)

Opal Colors

White Opal F (234)

Crystal Effects

Transparent Effects

Crystal Aurore Boreale F (001 AB)

Crystal Golden Shadow F (001 GSHA)

Crystal Ignite (001 IGNIT)

Crystal Silver Night F (001 SINI)

Crystal Silver Shade F (001 SSHA)

Crystal F (001)	◆	◆	◆	◆	◆
Amethyst F (204)	◆	◆	◆	◆	◆
Aquamarine F (202)	◆	◆	◆	◆	◆
Black Diamond F (215)	■	■	■	■	■
Emerald F (205)	◆	◆	◆	◆	◆
Golden Topaz F (1003)*	■	■	■	■	■
Iris F (219)	■	■	■	■	■
Jet (280)	◆	◆	◆	◆	◆
Light Amber F (1002)*	■	■	■	■	■
Light Colorado Topaz F (246)	◆	◆	◆	◆	◆
Light Rose F (223)	◆	◆	◆	◆	◆
Montana F (207)	■	■	■	■	■
Rose F (209)	■	■	■	■	■
Scarlet F (276)	◆	◆	◆	◆	◆
Siam F (208)	■	■	■	■	■
Smoked Amber F (1001)*	■	■	■	■	■
Tanzanite F (539)	■	■	■	■	■
Vintage Rose F (319)	■	■	■	■	■
White Opal F (234)	■	■	■	■	■
Crystal Aurore Boreale F (001 AB)	■	■	■	■	■
Crystal Golden Shadow F (001 GSHA)	■	■	■	■	■
Crystal Ignite (001 IGNIT)	■	■	■	■	■
Crystal Silver Night F (001 SINI)	■	■	■	■	■
Crystal Silver Shade F (001 SSHA)	■	■	■	■	■

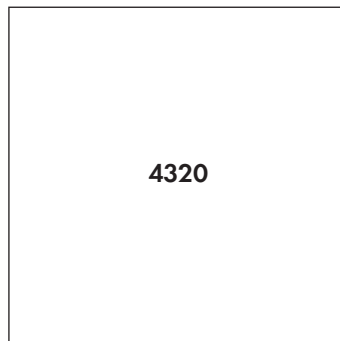

Size	6x4 mm	8x6 mm	10x7 mm	14x10 mm	18x13 mm
------	--------	--------	---------	----------	----------

Crystal Lacquer^{PRO} Effects

Crystal Lacquer^{PRO} DeLite Effects

Crystal Dusty Pink DeLite (001 L149D)

Crystal Ivory Cream DeLite (001 L106D)

Crystal Laguna DeLite (001 L142D)

Crystal Lavender DeLite (001 L144D)

Crystal Lotus Pink DeLite (001 L145D)

Crystal Ocean DeLite (001 L143D)

Crystal Orange Glow DeLite (001 L146D)

Crystal Royal Blue DeLite (001 L110D)

Crystal Royal Red DeLite (001 L107D)

Crystal Serene Gray DeLite (001 L150D)

Crystal Silky Sage DeLite (001 L147D)

Color Effects

Transparent Effects

Amethyst Ignite (204 IGNIT)

Aquamarine Ignite (202 IGNIT)

Emerald Ignite (205 IGNIT)

Light Colorado Topaz Ignite (246 IGNIT)

Light Rose Ignite (223 IGNIT)

Scarlet Ignite (276 IGNIT)

Crystal Dusty Pink DeLite (001 L149D)				■	■
Crystal Ivory Cream DeLite (001 L106D)				■	■
Crystal Laguna DeLite (001 L142D)				■	■
Crystal Lavender DeLite (001 L144D)				■	■
Crystal Lotus Pink DeLite (001 L145D)				■	■
Crystal Ocean DeLite (001 L143D)				■	■
Crystal Orange Glow DeLite (001 L146D)				■	■
Crystal Royal Blue DeLite (001 L110D)				■	■
Crystal Royal Red DeLite (001 L107D)				■	■
Crystal Serene Gray DeLite (001 L150D)				■	■
Crystal Silky Sage DeLite (001 L147D)				■	■
Amethyst Ignite (204 IGNIT)		■	■	■	■
Aquamarine Ignite (202 IGNIT)		■	■	■	■
Emerald Ignite (205 IGNIT)		■	■	■	■
Light Colorado Topaz Ignite (246 IGNIT)		■	■	■	■
Light Rose Ignite (223 IGNIT)		■	■	■	■
Scarlet Ignite (276 IGNIT)		■	■	■	■

02

* All colors with a 4-digit color code (i.e. Golden Topaz) are fully customizable with shorter lead times and lower MOQs compared to our 3-digit colors. Please get in touch with the Customer Service for a time and quantity estimation of your desired variant.

◆ Core Assortment

4322 Teardrop Fancy Stone

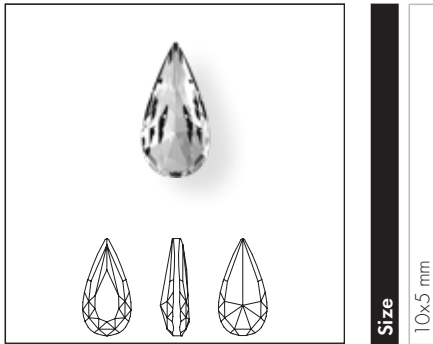

Size
10x5 mm

Crystal

Crystal F (001)

Colors

Plain Colors

Amethyst F (204)

Aquamarine F (202)

Black Diamond F (215)

Emerald F (205)

Jet (280)

Light Colorado Topaz F (246)

Montana F (207)

Scarlet F (276)

Tanzanite F (539)

Vintage Rose F (319)

Crystal Effects

Transparent Effects

Crystal Aurore Boreale F (001 AB)

Crystal Golden Shadow F (001 GSHA)

Crystal Silver Night (001 SINI)

Crystal Silver Shade F (001 SSHA)

4327 Large Pear Fancy Stone



Size
30x20 mm

Crystal

Crystal F (001)

Colors

Plain Colors

Amethyst F (204)

Aquamarine F (202)

Black Diamond F (215)

Jet (280)

Light Colorado Topaz F (246)

Light Rose F (223)

Montana F (207)

Tanzanite F (539)

Opal Colors

White Opal F (234)

Crystal Effects

Transparent Effects

Crystal Aurore Boreale F (001 AB)

Crystal Golden Shadow F (001 GSHA)

Crystal Silver Shade F (001 SSHA)

Crystal Lacquer^{PRO} Effects

Crystal Lacquer^{PRO} DeLite Effects

Crystal Dusty Pink DeLite (001 L149D)

Crystal Ivory Cream DeLite (001 L106D)

Crystal Laguna DeLite (001 L142D)

Crystal Lavender DeLite (001 L144D)

Crystal Lotus Pink DeLite (001 L145D)

Crystal Ocean DeLite (001 L143D)

Crystal Orange Glow DeLite (001 L146D)

Crystal Royal Blue DeLite (001 L110D)

Crystal Royal Red DeLite (001 L107D)

Crystal Serene Gray DeLite (001 L150D)

Crystal Silky Sage DeLite (001 L147D)

4328 XILION Pear Fancy Stone



Size	6x3.6 mm	8x4.8 mm
-------------	----------	----------

Crystal

Crystal F (001)

Colors

Plain Colors

Amethyst F (204)

Aquamarine F (202)

Black Diamond F (215)

Emerald F (205)

Jet (280)

Light Amethyst F (212)

Light Colorado Topaz F (246)

Light Rose F (223)

Montana F (207)

Rose F (209)

Scarlet F (276)

Siam F (208)

Tanzanite F (539)

Crystal Effects

Transparent Effects

Crystal Golden Shadow F (001 GSHA)

CORE ASSORTMENT

4428 XILION Square Fancy Stone

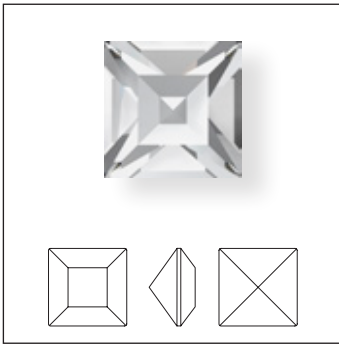

Size 1.5, 2 mm

4428 XILION Square Fancy Stone

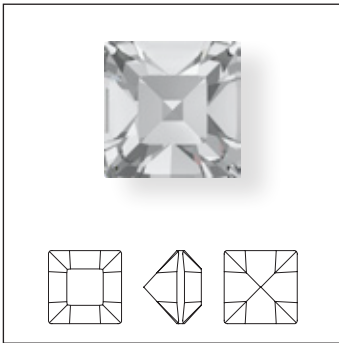

Size 3, 4 mm

4428 XILION Square Fancy Stone

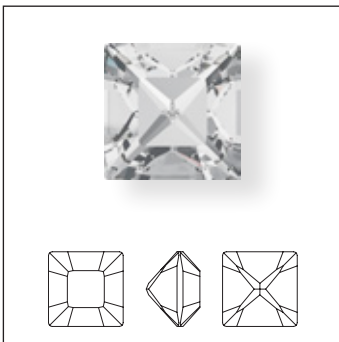

Size 8 mm

4428	Size	1.5 mm	2 mm	3 mm	4 mm	8 mm
Crystal						
Crystal F (001)		◆	◆	◆	◆	◆
Colors						
Plain Colors						
Amethyst F (204)		◆	◆	◆	◆	◆
Aquamarine F (202)		◆	◆	◆	◆	◆
Black Diamond F (215)		■	■	■	■	■
Emerald F (205)		◆	◆	◆	◆	◆
Iris F (219)		■	■	■	■	■
Jet (280)		◆	◆	◆	◆	◆
Light Amethyst F (212)		■	■	■	■	■
Light Colorado Topaz F (246)		◆	◆	◆	◆	◆
Light Rose F (223)		◆	◆	◆	◆	◆
Light Sapphire F (211)		■	■	■	■	■
Light Siam F (227)		■	■	■	■	■
Montana F (207)		■	■	■	■	■
Peridot F (214)		■	■	■	■	■
Rose F (209)		■	■	■	■	■
Sapphire F (206)		■	■	■	■	■
Scarlet F (276)		◆	◆	◆	◆	◆
Siam F (208)		■	■	■	■	■
Tanzanite F (539)		■	■	■	■	■
Opal Colors						
White Opal F (234)		■	■	■	■	■
Crystal Effects						
Transparent Effects						
Crystal Aurore Boreale F (001 AB)		■	■	■	■	■
Crystal Golden Shadow F (001 GSHA)		■	■	■	■	■
Crystal Silver Night F (001 SINI)		■	■	■	■	■
Crystal Silver Shade F (001 SSHA)		■	■	■	■	■

4447 Princess Square Fancy Stone

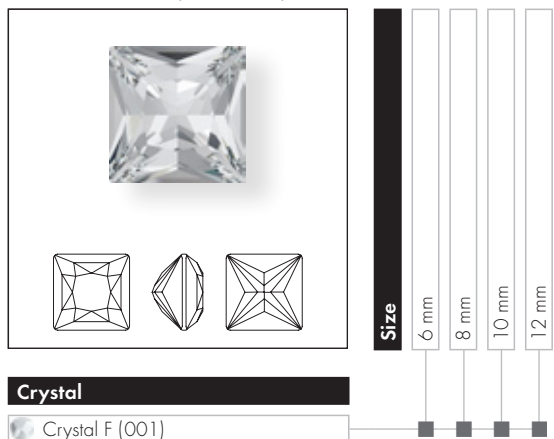

Technical diagrams for the Princess Square Fancy Stone include a top-down view of the stone, a side profile view, and a bottom-up view showing the pavilion facets. To the right, a vertical bar labeled 'Size' indicates four size options: 6 mm, 8 mm, 10 mm, and 12 mm. Below the diagrams, a 'Crystal' section lists 'Crystal F (001)' with a corresponding selection box.

4460 Mystic Square Fancy Stone

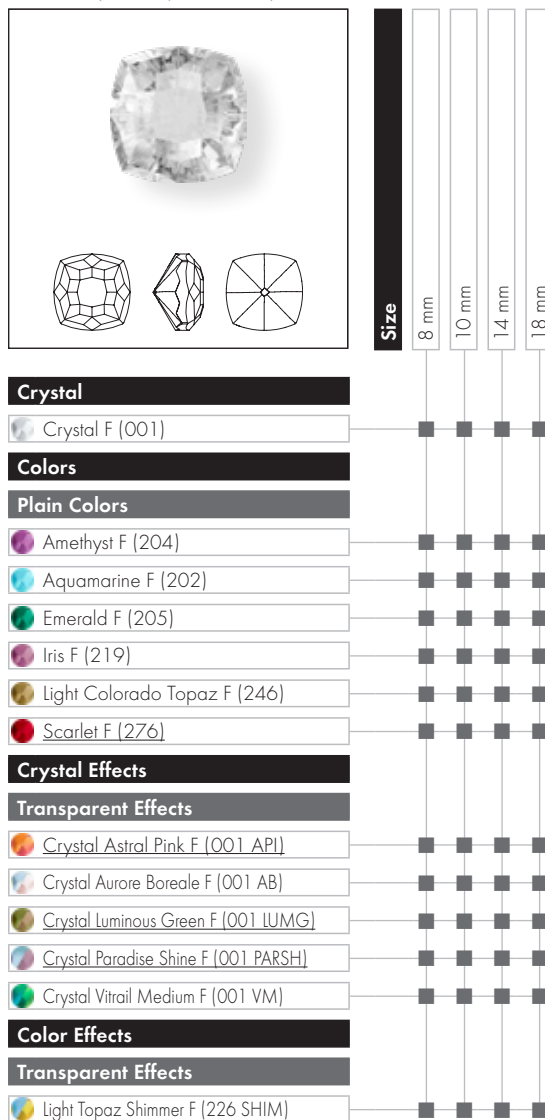

Technical diagrams for the Mystic Square Fancy Stone include a top-down view of the stone, a side profile view, and a bottom-up view showing the pavilion facets. To the right, a vertical bar labeled 'Size' indicates four size options: 8 mm, 10 mm, 14 mm, and 18 mm. Below the diagrams, a 'Crystal' section lists 'Crystal F (001)'. A 'Colors' section is titled 'Plain Colors' and includes: Amethyst F (204), Aquamarine F (202), Emerald F (205), Iris F (219), Light Colorado Topaz F (246), and Scarlet F (276). A 'Crystal Effects' section is titled 'Transparent Effects' and includes: Crystal Astral Pink F (001 API), Crystal Aurore Boreale F (001 AB), Crystal Luminous Green F (001 LUMG), Crystal Paradise Shine F (001 PARSH), and Crystal Vitrail Medium F (001 VM). A 'Color Effects' section is titled 'Transparent Effects' and includes: Light Topaz Shimmer F (226 SHIM). Selection boxes with checkboxes are provided for each option.

CORE ASSORTMENT

4470 Cushion Square Fancy Stone



Size
10 mm
12 mm

Crystal	10 mm	12 mm
Crystal F (001)	◆	◆
Colors		
Plain Colors		
Amethyst F (204)	◆	◆
Aquamarine F (202)	◆	◆
Black Diamond F (215)	■	■
Emerald F (205)	◆	◆
Golden Topaz F (1003)*	■	■
Iris F (219)	■	■
Jet (280)	◆	◆
Light Amber F (1002)*	■	■
Light Colorado Topaz F (246)	◆	◆
Light Rose F (223)	◆	◆
Light Sapphire F (211)	■	■
Light Siam F (227)	■	■
Light Topaz F (226)	■	■
Scarlet F (276)	◆	◆
Siam F (208)	■	■
Smoked Amber F (1001)*	■	■
Tanzanite F (539)	■	■
Vintage Rose F (319)	■	■
Opal Colors		
White Opal F (234)	■	■
Crystal Effects		
Transparent Effects		
Crystal Aurore Boreale F (001 AB)	■	■
Crystal Golden Shadow F (001 GSHA)	■	■
Crystal Ignite (001 IGNIT)	■	■
Crystal Silver Night F (001 SINI)	■	■
Crystal Silver Shade F (001 SSHA)	■	■

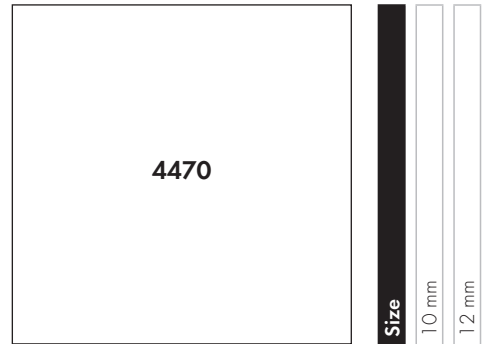

Size
10 mm
12 mm

Crystal Lacquer ^{PRO} Effects	10 mm	12 mm
Crystal Lacquer ^{PRO} DeLite Effects		
Crystal Dusty Pink DeLite (001 L149D)	■	■
Crystal Ivory Cream DeLite (001 L106D)	■	■
Crystal Laguna DeLite (001 L142D)	■	■
Crystal Lavender DeLite (001 L144D)	■	■
Crystal Lotus Pink DeLite (001 L145D)	■	■
Crystal Ocean DeLite (001 L143D)	■	■
Crystal Orange Glow DeLite (001 L146D)	■	■
Crystal Royal Blue DeLite (001 L110D)	■	■
Crystal Royal Red DeLite (001 L107D)	■	■
Crystal Serene Gray DeLite (001 L150D)	■	■
Crystal Silky Sage DeLite (001 L147D)	■	■
Color Effects		
Transparent Effects		
Amethyst Ignite (204 IGNIT)	■	■
Aquamarine Ignite (202 IGNIT)	■	■
Emerald Ignite (205 IGNIT)	■	■
Light Colorado Topaz Ignite (246 IGNIT)	■	■
Light Rose Ignite (223 IGNIT)	■	■
Scarlet Ignite (276 IGNIT)	■	■

* All colors with a 4-digit color code (i.e. Golden Topaz) are fully customizable with shorter lead times and lower MOQs compared to our 3-digit colors. Please get in touch with the Customer Service for a time and quantity estimation of your desired variant.

◆ Core Assortment

4471 Rose Cut Cushion Fancy Stone



Size
8 mm
10 mm
12 mm

Crystal	8 mm	10 mm	12 mm
Crystal F (001)	■	■	■
Colors			
Plain Colors			
Amethyst F (204)	■	■	■
Aquamarine F (202)	■	■	■
Emerald F (205)	■	■	■
Jet (280)	■	■	■
Light Colorado Topaz F (246)	■	■	■
Montana F (207)	■	■	■
Scarlet F (276)	■	■	■
Tanzanite F (539)	■	■	■
Vintage Rose F (319)	■	■	■
Opal Colors			
Rose Water Opal F (395)	■	■	■
White Opal F (234)	■	■	■
Crystal Effects			
Transparent Effects			
Crystal Aurore Boreale F (001 AB)	■	■	■
Crystal Golden Shadow F (001 GSHA)	■	■	■
Crystal Ignite (001 IGNIT)	■	■	■
Crystal Silver Shade F (001 SSHA)	■	■	■
Color Effects			
Transparent Effects			
Amethyst Ignite (204 IGNIT)	■	■	■
Aquamarine Ignite (202 IGNIT)	■	■	■
Emerald Ignite (205 IGNIT)	■	■	■
Light Colorado Topaz Ignite (246 IGNIT)	■	■	■
Light Rose Ignite (223 IGNIT)	■	■	■
Scarlet Ignite (276 IGNIT)	■	■	■

4480 Imperial Fancy Stone



Size
6 mm
8 mm
10 mm
14 mm
18 mm

Crystal	6 mm	8 mm	10 mm	14 mm	18 mm
Crystal F (001)	■	■	■	■	■
Colors					
Plain Colors					
Amethyst F (204)	■	■	■	■	■
Aquamarine F (202)	■	■	■	■	■
Emerald F (205)	■	■	■	■	■
Iris F (219)	■	■	■	■	■
Jet (280)	■	■	■	■	■
Light Colorado Topaz F (246)	■	■	■	■	■
Light Rose F (223)	■	■	■	■	■
Montana F (207)	■	■	■	■	■
Scarlet F (276)	■	■	■	■	■
Crystal Effects					
Transparent Effects					
Crystal Aurore Boreale F (001 AB)	■	■	■	■	■
Crystal Golden Shadow F (001 GSHA)	■	■	■	■	■
Crystal Ignite (001 IGNIT)	■	■	■	■	■
Crystal Silver Night (001 SINI)	■	■	■	■	■
Crystal Silver Shade F (001 SSHA)	■	■	■	■	■
Color Effects					
Transparent Effects					
Amethyst Ignite (204 IGNIT)	■	■	■	■	■
Aquamarine Ignite (202 IGNIT)	■	■	■	■	■
Emerald Ignite (205 IGNIT)	■	■	■	■	■
Light Colorado Topaz Ignite (246 IGNIT)	■	■	■	■	■
Light Rose Ignite (223 IGNIT)	■	■	■	■	■
Scarlet Ignite (276 IGNIT)	■	■	■	■	■

4483 Fantasy Cushion Fancy Stone



Size
8 mm
10 mm
12 mm
14 mm

Crystal

Crystal F (001)

Colors

Plain Colors

Amethyst F (204)

Aquamarine F (202)

Emerald F (205)

Iris F (219)

Jet (280)

Light Colorado Topaz F (246)

Majestic Blue F (296)

Scarlet F (276)

Tanzanite F (539)

Vintage Rose F (319)

Opal Colors

White Opal F (234)

Crystal Effects

Transparent Effects

Crystal Golden Shadow F (001 GSHA)

Crystal Silver Night (001 SINI)

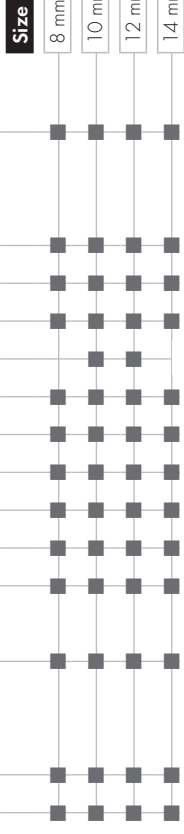

4499 Kaleidoscope Square Fancy Stone

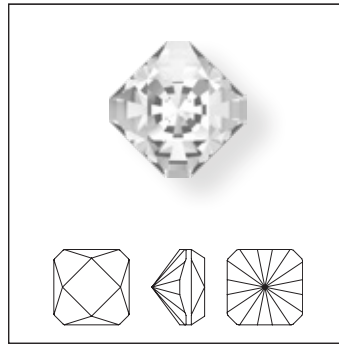

Size
6 mm
10 mm
14 mm
20 mm

Crystal Effects

Crystal Lacquer^{PRO} Effects

Crystal Lacquer^{PRO} DeLite Effects

Crystal Dusty Pink DeLite (001 L149D)

Crystal Ivory Cream DeLite (001 L106D)

Crystal Serene Gray DeLite (001 L150D)

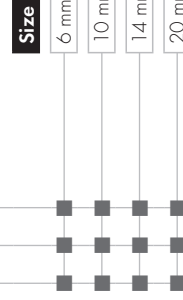

4500 Thin Baguette Fancy Stone

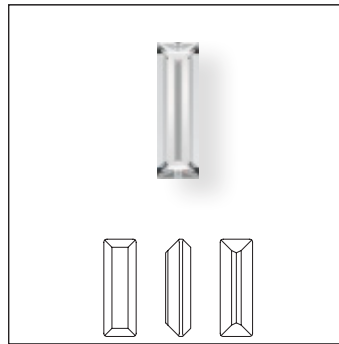

Size
3x2 mm
6x2 mm

Crystal

Crystal F (001)

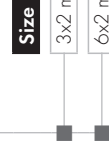

CORE ASSORTMENT

4501 Baguette Fancy Stone

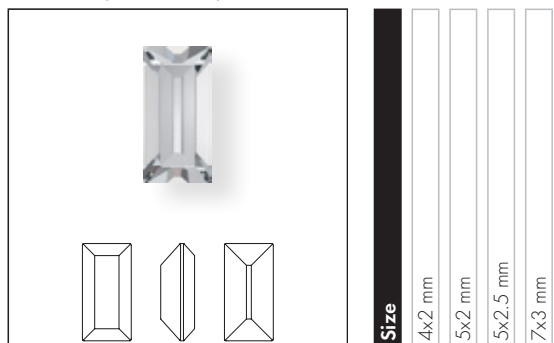

Crystal

Crystal F (001)

Colors

Plain Colors

Amethyst F (204)

Aquamarine F (202)

Black Diamond F (215)

Emerald F (205)

Jet (280)

Light Amethyst F (212)

Light Colorado Topaz F (246)

Light Rose F (223)

Light Sapphire F (211)

Montana F (207)

Rose F (209)

Sapphire F (206)

Scarlet F (276)

Siam F (208)

Tanzanite F (539)

Crystal Effects

Transparent Effects

Crystal Aurore Boreale F (001 AB)

Crystal Golden Shadow F (001 GSXA)

Crystal Silver Night F (001 SINI)

Crystal Silver Shade F (001 SSHA)

4502 Small Baguette Fancy Stone

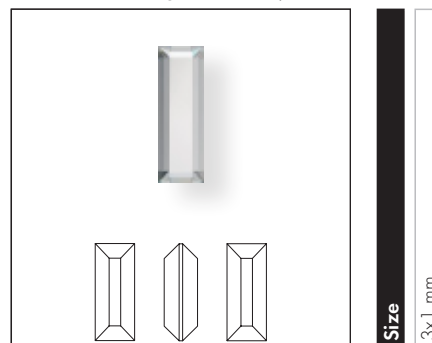

Crystal

Crystal F (001)

02

4547 Princess Baguette Fancy Stone



Crystal

Crystal F (001)

4568 Cushion Fancy Stone

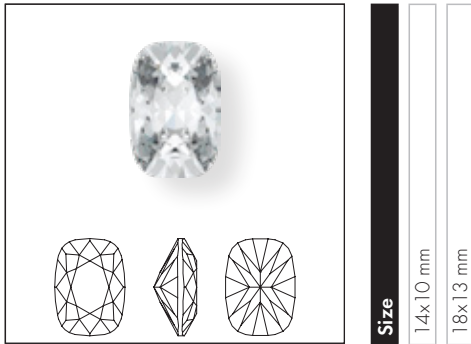

Size

14x10 mm

18x13 mm

Crystal

Crystal F (001)

Colors

Plain Colors

Aquamarine F (202)

Jet (280)

Light Colorado Topaz F (246)

Light Siam F (227)

Rose F (209)

Tanzanite F (539)

Crystal Effects

Transparent Effects

Crystal Golden Shadow F (001 GSHA)

Crystal Silver Night (001 SINI)

Crystal Silver Shade F (001 SSHA)

4595 Elongated Imperial Fancy Stone

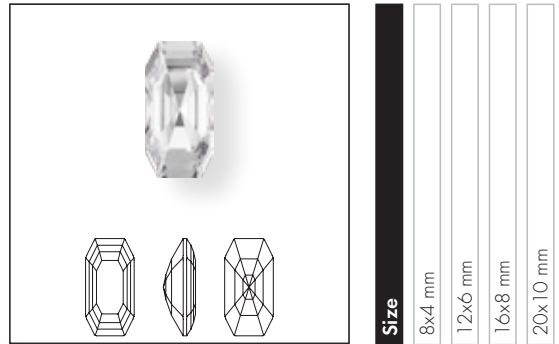

Size

8x4 mm

12x6 mm

16x8 mm

20x10 mm

Crystal

Crystal F (001)

Colors

Plain Colors

Amethyst F (204)

Aquamarine F (202)

Emerald F (205)

Iris F (219)

Jet (280)

Light Colorado Topaz F (246)

Majestic Blue F (296)

Scarlet F (276)

Crystal Effects

Transparent Effects

Crystal Aurore Boreale F (001 AB)

Crystal Golden Shadow F (001 GSHA)

Crystal Silver Night (001 SINI)

Crystal Silver Shade F (001 SSHA)

Color Effects

Metallic Effects

Jet Hematite (280 HEM)

4600 Octagon Fancy Stone

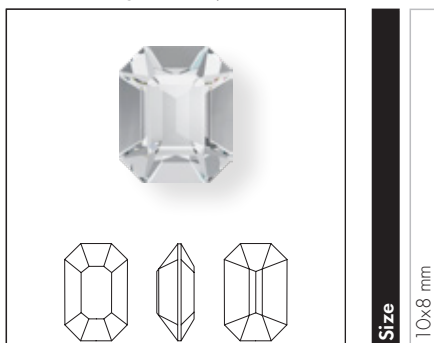

Size
10x8 mm

- Crystal**
- Crystal F (001)
- Colors**
- Plain Colors**
- Jet (280)
- Montana F (207)
- Rose F (209)
- Crystal Effects**
- Transparent Effects**
- Crystal Golden Shadow F (001 GSHA)
- Crystal Silver Shade F (001 SSHA)

4610 Curved Back Octagon Fancy Stone



Size
14x10 mm
18x13 mm

- Crystal**
- Crystal F (001)
- Colors**
- Plain Colors**
- Amethyst F (204)
- Aquamarine F (202)
- Black Diamond F (215)
- Emerald F (205)
- Jet (280)
- Light Colorado Topaz F (246)
- Montana F (207)
- Peridot F (214)
- Siam F (208)
- Tanzanite F (539)
- Crystal Effects**
- Transparent Effects**
- Crystal Golden Shadow F (001 GSHA)
- Crystal Ignite (001 IGNIT)
- Crystal Silver Shade F (001 SSHA)

4627 Thin Octagon Fancy Stone



Size
27x18.5 mm

Crystal

Crystal F (001)

Colors

Plain Colors

Amethyst F (204)

Aquamarine F (202)

Black Diamond F (215)

Emerald F (205)

Jet (280)

Light Colorado Topaz F (246)

Montana F (207)

Tanzanite F (539)

Crystal Effects

Transparent Effects

Crystal Aurore Boreale F (001 AB)

Crystal Golden Shadow F (001 GSHA)

Crystal Silver Shade F (001 SSHA)

4683 Fantasy Hexagon Fancy Stone



Size
7.8x8.7 mm
10x11.2 mm
12x13.5 mm
14x15.8 mm

Crystal

Crystal F (001)

Colors

Plain Colors

Amethyst F (204)

Aquamarine F (202)

Emerald F (205)

Iris F (219)

Jet (280)

Light Colorado Topaz F (246)

Majestic Blue F (296)

Scarlet F (276)

Tanzanite F (539)

Vintage Rose F (319)

Opal Colors

White Opal F (234)

Crystal Effects

Transparent Effects

Crystal Golden Shadow F (001 GSHA)

Crystal Silver Night (001 SINI)

4699 Kaleidoscope Hexagon Fancy Stone

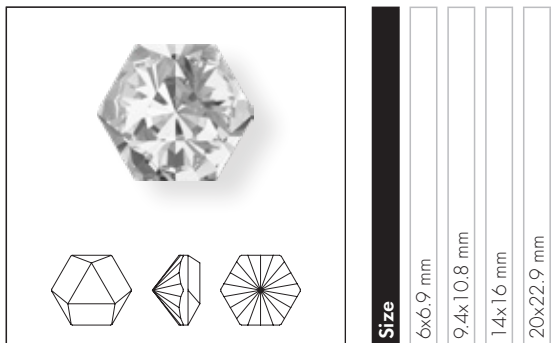

Size

- 6x6.9 mm
- 9.4x10.8 mm
- 14x 16 mm
- 20x22.9 mm

Crystal Effects

Crystal Lacquer^{PRO} Effects

Crystal Lacquer^{PRO} DeLite Effects

- Crystal Dusty Pink DeLite (001 L149D)
- Crystal Ivory Cream DeLite (001 L106D)
- Crystal Serene Gray DeLite (001 L150D)

4706 Trilliant Fancy Stone



Size

- 7 mm
- 12 mm
- 17 mm

Crystal

- Crystal F (001)

Colors

- Plain Colors
- Amethyst F (204)
- Aquamarine F (202)
- Iris F (219)
- Light Colorado Topaz F (246)
- Rose F (209)
- Scarlet F (276)
- Tanzanite F (539)
- Vintage Rose F (319)

Crystal Effects

Transparent Effects

- Crystal Aurore Boreale F (001 AB)
- Crystal Golden Shadow F (001 GSHA)
- Crystal Ignite (001 IGNIT)
- Crystal Silver Night (001 SINI)
- Crystal Silver Shade F (001 SSHA)

4722 Triangle Fancy Stone

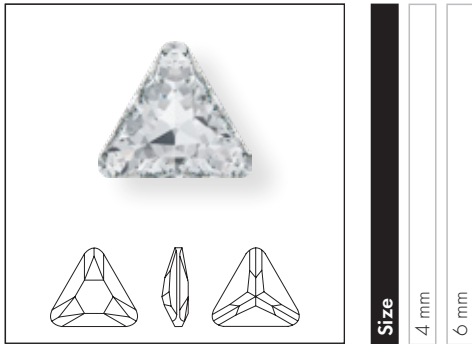

Size
4 mm
6 mm

Crystal

Crystal F (001)

4745 Rivoli Star Fancy Stone



Size
5 mm
10 mm

Crystal

Crystal F (001)

Colors

Plain Colors

Jet (280)

Crystal Effects

Transparent Effects

Crystal Aurore Boreale F (001 AB)

Crystal Golden Shadow F (001 GSHA)

Crystal Silver Shade F (001 SSHA)

4799 Kaleidoscope Triangle Fancy Stone



Size
6x6.1 mm
9.2x9.4 mm
14x14.3 mm
20x20.4 mm

Crystal Effects

Crystal Lacquer^{PRO} Effects

Crystal Lacquer^{PRO} DeLite Effects

Crystal Dusty Pink DeLite (001 L149D)

Crystal Ivory Cream DeLite (001 L106D)

Crystal Serene Gray DeLite (001 L150D)

4809 Sweet Heart Fancy Stone

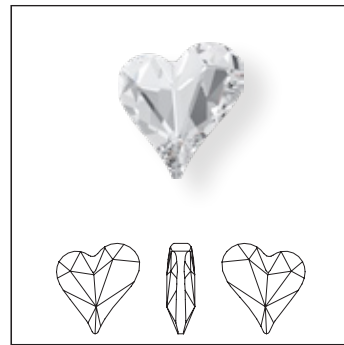

Size
13x12 mm

Crystal

Crystal F (001)

Colors

Plain Colors

Amethyst F (204)

Light Siam F (227)

Rose F (209)

Crystal Effects

Transparent Effects

Crystal Aurore Boreale F (001 AB)

Crystal Golden Shadow F (001 GSHA)

Crystal Silver Night (001 SINI)

4841 Cube Fancy Stone



Size
4 mm
6 mm
8 mm

- Crystal**
- Crystal Comet Argent Light V Z (001 CAVZ)
- Colors**
- Plain Colors**
- Aquamarine Comet Argent Light V Z (202 CAVZ)
- Light Rose Comet Argent Light V Z (223 CAVZ)
- Light Siam Comet Argent Light V Z (227 CAVZ)
- Crystal Effects**
- Transparent Effects**
- Crystal Aurore Boreale CAL V Z (001 ABCVZ)
- Crystal Golden Shadow CAL V Z (001 GSCVZ)

4869 Disco Fancy Stone

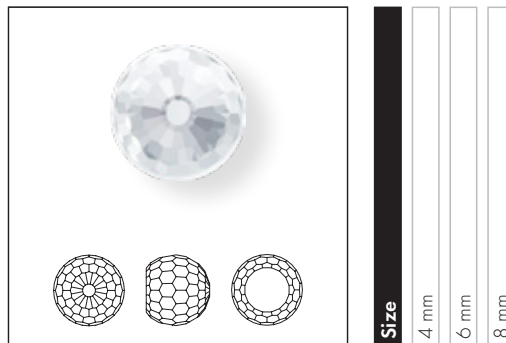

Size
4 mm
6 mm
8 mm

- Crystal**
- Crystal Comet Argent Light V Z (001 CAVZ)
- Colors**
- Plain Colors**
- Aquamarine Comet Argent Light V Z (202 CAVZ)
- Light Rose Comet Argent Light V Z (223 CAVZ)
- Crystal Effects**
- Transparent Effects**
- Crystal Aurore Boreale CAL V Z (001 ABCVZ)

4884 XILLION Heart Fancy Stone



Size	5.5x5 mm	6.6x6 mm	8.8x8 mm	11x10 mm
------	----------	----------	----------	----------

Crystal

Crystal F (001)

Colors

Plain Colors

Aquamarine F (202)

Light Amethyst F (212)

Light Rose F (223)

Light Siam F (227)

Montana F (207)

Peridot F (214)

Rose F (209)

Crystal Effects

Transparent Effects

Crystal Golden Shadow F (001 GSHA)

Crystal Ignite (001 IGNIT)

Crystal F (001)	■	■	■	■
Aquamarine F (202)	■	■	■	
Light Amethyst F (212)	■	■	■	
Light Rose F (223)	■	■	■	
Light Siam F (227)	■	■	■	
Montana F (207)	■	■	■	
Peridot F (214)	■	■	■	
Rose F (209)	■	■	■	
Crystal Golden Shadow F (001 GSHA)	■	■	■	
Crystal Ignite (001 IGNIT)	■	■	■	■

Product Details

Article Size	Packing Unit = Minimum Order Quantity in Pieces	Average Net Weight in Gram per Packing Unit Crystal (001)	Average Gross Weight in Gram per Packing Unit Crystal (001)
4120			
6x4 mm	360	31.2	42.1
8x6 mm	180	44.7	45.2
14x10 mm	144	170.2	193.8
18x13 mm	48	112.3	132.9
4122			
8x6 mm	180	41.1	42.5
14x10.5 mm	108	127.0	150.5
18x13.5 mm	48	95.6	115.0
4127			
30x22 mm	24	173.6	218.7
4128			
6x4 mm	360	26.8	37.6
8x6 mm	360	76.5	87.3
4160			
8x6 mm	90	23.9	43.5
10x8 mm	72	40.1	59.8
14x10 mm	48	65.9	85.6
18x13 mm	24	70.7	90.3
4161			
15x5 mm	72	29.5	51.6
4162			
10x5.5 mm	144	23.8	34.9
14x7.5 mm	72	36.0	56.4
18x9.5 mm	48	49.6	70.5
4228			
4x2 mm	720	9.2	18.3
5x2.5 mm	720	18.9	28.0
6x3 mm	720	30.5	39.6
8x4 mm	360	32.9	42.0
10x5 mm	360	60.7	72.1
15x7 mm	144	63.9	88.1
4320			
6x4 mm	360	25.7	34.8
8x6 mm	180	30.7	39.8
10x7 mm	144	48.6	68.9
14x10 mm	144	126.6	150.2
18x13 mm	48	85.2	105.8
4322			
10x5 mm	72	13.95	33.93
4327			
30x20 mm	24	161.8	206.8
4328			
6x3.6 mm	720	40.0	50.5
8x4.8 mm	360	42.1	53.0

Article Size	Packing Unit = Minimum Order Quantity in Pieces	Average Net Weight in Gram per Packing Unit Crystal (001)	Average Gross Weight in Gram per Packing Unit Crystal (001)
4428			
1.5 mm	1,440	4.32	15.1
2 mm	1,440	12.2	23.0
3 mm	1,440	34.8	57.6
4 mm	1,440	108.5	119.5
8 mm	144	84.5	99.6
4447			
6 mm	360	87.5	98.3
8 mm	144	71.5	91.9
10 mm	144	133.9	157.2
12 mm	72	117.6	137.9
4460			
8 mm	72	32.1	49.2
10 mm	48	41.1	58.8
14 mm	24	55.1	70.4
18 mm	15	70.5	88.7
4470			
10 mm	144	91.6	111.9
12 mm	72	74.7	92.9
4471			
8 mm	144	41.3	66.4
10 mm	96	54.3	77.5
12 mm	48	43.3	67.6
4480			
6 mm	288	50.02	73.28
8 mm	144	65.95	87.79
10 mm	96	86.30	110.13
14 mm	48	115.2	136.1
18 mm	15	75.0	92.9
4483			
8 mm	144	63.3	88.4
10 mm	96	77.76	104.6
12 mm	48	66.7	91.1
14 mm	24	53.0	72.8
4499			
6 mm	144	29.4	50.1
10 mm	48	54.0	73.7
14 mm	24	69.9	91.2
20 mm	12	103.6	128.0
4500			
3x2 mm	1,440	20.5	32.0
6x2 mm	720	18.4	27.5
4501			
4x2 mm	720	16.8	25.9
5x2 mm	720	18.1	27.2
5x2.5 mm	720	20.9	30.0
7x3 mm	720	60.2	71.1

Article Size	Packing Unit = Minimum Order Quantity in Pieces	Average Net Weight in Gram per Packing Unit Crystal (001)	Average Gross Weight in Gram per Packing Unit Crystal (001)
4502			
3x1 mm	720	2.2	11.4
4547			
15x5 mm	72	37.4	58.9
21x7 mm	48	65.3	98.7
4568			
14x10 mm	72	74.9	103.1
18x13 mm	24	46.2	64.7
4595			
8 mm	144	22.6	47.7
12 mm	72	31.3	54.9
16 mm	48	41.7	65.4
20 mm	30	59.6	89.9
4600			
10x8 mm	144	84.0	104.0
4610			
14x10 mm	144	171.3	194.9
18x13 mm	48	124.9	145.5
4627			
27x18.5 mm	24	125.3	170.8
4683			
7.8x8.7 mm	144	57.3	80.5
10x11.2 mm	96	75.8	99.4
12x13.5 mm	48	61.0	84.7
14x15.8 mm	24	46.4	67.0
4699			
6x6.9 mm	144	26.5	51.2
9.4x10.8 mm	48	39.1	59.7
14x16 mm	24	71.3	92.0
20 x22.9 mm	12	86.3	110.6
4706			
7 mm	144	23.7	44.4
12 mm	72	61.5	83.9
17 mm	48	96.4	119.8
4722			
4 mm	480	12.0	21.1
6 mm	180	16.4	25.5
4745			
5 mm	720	35.6	46.4
10 mm	144	48.5	71.3
4799			
6x6.1 mm	144	18.6	42.9
9.2x9.4 mm	48	24.3	44.5
14x14.3 mm	24	38.5	59.2
20 x20.4 mm	12	48.7	78.2

Article Size	Packing Unit = Minimum Order Quantity in Pieces	Average Net Weight in Gram per Packing Unit Crystal (001)	Average Gross Weight in Gram per Packing Unit Crystal (001)
4809			
13x12 mm	72	47.8	68.5
4841			
4 mm	288	45.3	66.6
6 mm	144	77.2	95.3
8 mm	72	89.2	107.4
4869			
4 mm	480	36.2	45.3
6 mm	180	47.2	56.4
8 mm	144	90.8	109.0
4884			
5.5x5 mm	360	39.0	49.7
6.6x6 mm	360	67.2	78.0
8.8x8 mm	288	111.4	138.1
11x10 mm	144	107.3	127.4

