



Flat Backs Hotfix

Flat Backs Hotfix are loose crystal elements with a flat reverse side that has been pre coated with a heat sensitive glue. These Flat Backs can be easily applied to a large range of textile carrier materials using heat to produce a durable and long lasting crystal effect.























Flat Backs Hotfix are available in a multitude of colors, shapes, and cuts. The increased light reflection and warmer appearance of the Flat Back Rose are achieved through a special silver mirror on the reverse side.























The most innovative single item in this product group is art 2078 XIRIUS Rose, with the most progressive and unique cut on the market multilayer cut technology, producing the inspiring XIRIUS star design. Superior shine and rich, well balanced refraction of light redefine the market standard.

Swarovski's outstanding quality in crystal elements is underlined by the highest precision in table size and diameter.















Colors & Effects

Colors

-  Crystal 001
-  Crystal Hotfix Transparent² 001 HFT
-  White Opal 234
-  Light Silk 261
-  Silk 391
-  Light Peach 362
-  Vintage Rose 319
-  Light Rose 223
-  Rose 209
-  Blush Rose 257
-  Padparadscha 542
-  Light Siam 227
-  Scarlet 276
-  Indian Siam² 327
-  Ruby 501
-  Siam 208
-  Fuchsia 502
-  Amethyst 204
-  Iris 219
-  Light Amethyst 212
-  Tanzanite 539
-  Light Sapphire 211

-  Aquamarine 202
-  Sapphire 206
-  Capri Blue 243
-  Majestic Blue¹ 296
-  Montana 207
-  Light Turquoise 263
-  Blue Zircon 229
-  Denim Blue 266
-  Black Diamond 215
-  Peridot 214
-  Erinite 360
-  Emerald 205
-  Greige 284
-  Light Colorado Topaz 246
-  Jonquill 213
-  Light Topaz 226
-  Golden Topaz 1003
-  Topaz 203
-  Light Amber 1002
-  Smoked Amber 1001
-  Graphite 253
-  Jet 280

Effects







-  Crystal Silver Shade 001 SSHA
-  Crystal Moonlight 001 MOL
-  Crystal Transmission Hotfix Transparent 001 TRA HFT
-  Crystal Aurore Boreale 001 AB
-  Crystal Shimmer 001 SHIM
-  Crystal Golden Shadow 001 GSHA
-  Crystal Metallic Sunshine 001 METSH
-  Crystal Rose Gold 001 ROGL
-  Crystal Volcano 001 VOL
-  Crystal Paradise Shine 001 PARSH
-  Crystal Blue Shade 001 BLSH
-  Crystal Light Chrome 001 LTCH
-  Crystal Silver Night 001 SINI
-  Jet Hematite 280 HEM

Crystal Lacquer^{Pro} Effects

Crystal Lacquer^{Pro} DeLite Effects

-  Crystal Ivory Cream DeLite
001 L106D
-  Crystal Orange Glow DeLite
001 L146D
-  Crystal Lotus Pink DeLite
001 L145D
-  Crystal Royal Red DeLite
001 L107D
-  Crystal Dusty Pink DeLite
001 L149D
-  Crystal Lavender DeLite
001 L144D
-  Crystal Ocean DeLite
001 L143D
-  Crystal Royal Blue DeLite
001 L110D
-  Crystal Laguna DeLite
001 L142D
-  Crystal Silky Sage DeLite
001 L147D
-  Crystal Serene Gray DeLite
001 L150D





Crystal Electric Lacquer^{Pro} Effects

-  Crystal Electric White
001 L139S
-  Crystal Electric Orange
001 L136S
-  Crystal Electric Pink
001 L137S
-  Crystal Electric Violet
001 L148S
-  Crystal Electric Blue
001 L134S
-  Crystal Electric Green
001 L135S
-  Crystal Electric Yellow
001 L138S

Shimmer Effects

-  Silk Shimmer
391 SHIM
-  Light Rose Shimmer
223 SHIM
-  Light Siam Shimmer
227 SHIM
-  Fuchsia Shimmer
502 SHIM
-  Tanzanite Shimmer
539 SHIM
-  Light Sapphire Shimmer
211 SHIM
-  Blue Zircon Shimmer
229 SHIM
-  Black Diamond Shimmer
215 SHIM
-  Peridot Shimmer
214 SHIM
-  Topaz Shimmer
203 SHIM

AB Effects

-  Light Siam Aurore Boreale
227 AB
-  Light Rose Aurore Boreale
223 AB
-  Sapphire Aurore Boreale
206 AB
-  Jonquil Aurore Boreale
213 AB
-  Jet Aurore Boreale
280 AB



Nightfall Effects

-  Siam Nightfall
208 NIFA
-  Capri Blue Nightfall
243 NIFA
-  Emerald Nightfall
205 NIFA
-  Graphite Nightfall
253 NIFA

Cabochons

-  Crystal White Pearl
001 650
-  Crystal Nacre
001 191
-  Crystal Creampearl
001 291
-  Crystal Golden Shadow
001 GSHA
-  Crystal Rosaline Pearl
001 294
-  Crystal Dark Grey Pearl
001 617
-  Jet
280
-  Jet Hematite
280 HEM

Rimmed Flat Backs

-  Light Siam Light Chrome Z
227 LTCHZ
-  Black Diamond Light Chrome Z
215 LTCHZ
-  Jet Light Chrome Z
280 LTCHZ

Numerical Order

001	Crystal	001 SSHA	<u>Crystal Silver Shade</u>	229 SHIM	Blue Zircon Shimmer
001 191	Crystal Nacre	001 TRAHFT	Crystal Transmission Hotfix Transparent	234	White Opal
001 291	Crystal Creampearl	001 VOL	Crystal Volcano	243	Capri Blue
001 294	Crystal Rosaline Pearl	202	Aquamarine	<u>243 NIFA</u>	<u>Capri Blue Nightfall</u>
001 617	Crystal Dark Grey Pearl	203	Topaz	246	Light Colorado Topaz
001 650	Crystal White Pearl	203 SHIM	Topaz Shimmer	253	Graphite
001 AB	Crystal Aurore Boreale	204	Amethyst	<u>253 NIFA</u>	<u>Graphite Nightfall</u>
001 BLSH	Crystal Blue Shade	205	Emerald	257	Blush Rose
001 GSHA	Crystal Golden Shadow	<u>205 NIFA</u>	<u>Emerald Nightfall</u>	261	Light Silk
001 HFT	Crystal Hotfix Transparent ²	206	Sapphire	263	Light Turquoise
<u>001 LI06D</u>	<u>Crystal Ivory Cream DeLite</u>	206 AB	Sapphire Aurore Boreale	<u>266</u>	<u>Denim Blue</u>
<u>001 LI07D</u>	<u>Crystal Royal Red DeLite</u>	207	Montana	<u>276</u>	<u>Scarlet</u>
<u>001 LI10D</u>	<u>Crystal Royal Blue DeLite</u>	208	Siam	280	Jet
<u>001 LI34S</u>	<u>Crystal Electric Blue</u>	<u>208 NIFA</u>	<u>Siam Nightfall</u>	280 AB	Jet Aurore Boreale
<u>001 LI35S</u>	<u>Crystal Electric Green</u>	209	Rose	280 HEM	Jet Hematite
<u>001 LI36S</u>	<u>Crystal Electric Orange</u>	211	Light Sapphire	280 LTCHZ	Jet Light Chrome Z
<u>001 LI37S</u>	<u>Crystal Electric Pink</u>	211 SHIM	Light Sapphire Shimmer	<u>284</u>	Greige
<u>001 LI38S</u>	<u>Crystal Electric Yellow</u>	212	Light Amethyst	<u>296</u>	<u>Majestic Blue¹</u>
<u>001 LI39S</u>	<u>Crystal Electric White</u>	213	Jonquil	319	Vintage Rose
<u>001 LI42D</u>	<u>Crystal Laguna DeLite</u>	213 AB	Jonquil Aurore Boreale	<u>327</u>	<u>Indian Siam²</u>
<u>001 LI43D</u>	<u>Crystal Ocean DeLite</u>	214	Peridot	360	Erinite
<u>001 LI44D</u>	<u>Crystal Lavender DeLite</u>	214 SHIM	Peridot Shimmer	362	Light Peach
<u>001 LI45D</u>	<u>Crystal Lotus Pink DeLite</u>	215	Black Diamond	391	Silk
<u>001 LI46D</u>	<u>Crystal Orange Glow DeLite</u>	215 LTCHZ	Black Diamond Light Chrome Z	391 SHIM	Silk Shimmer
<u>001 LI47D</u>	<u>Crystal Silky Sage DeLite</u>	215 SHIM	Black Diamond Shimmer	501	Ruby
<u>001 LI48S</u>	<u>Crystal Electric Violet</u>	219	Iris	502	Fuchsia
<u>001 LI49D</u>	<u>Crystal Dusty Pink DeLite</u>	223	Light Rose	502 SHIM	Fuchsia Shimmer
<u>001 LI50D</u>	<u>Crystal Serene Gray DeLite</u>	223 AB	Light Rose Aurore Boreale	539	Tanzanite
<u>001 LTCH</u>	<u>Crystal Light Chrome</u>	223 SHIM	Light Rose Shimmer	539 SHIM	Tanzanite Shimmer
001 METSH	Crystal Metallic Sunshine	226	Light Topaz	542	Padparadscha
001 MOL	Crystal Moonlight	227	Light Siam	<u>1001</u>	<u>Smoked Amber</u>
<u>001 PARSH</u>	<u>Crystal Paradise Shine</u>	227 AB	Light Siam Aurore Boreale	<u>1002</u>	<u>Light Amber</u>
<u>001 ROGL</u>	<u>Crystal Rose Gold</u>	227 LTCHZ	Light Siam Light Chrome Z	<u>1003</u>	<u>Golden Topaz</u>
001 SHIM	Crystal Shimmer	227 SHIM	Light Siam Shimmer		
001 SINI	Crystal Silver Night	229	Blue Zircon		

Alphabetical Order

Amethyst (204)
 Aquamarine (202)
 Black Diamond (215)
 Black Diamond Light Chrome Z (215 LTCHZ)
 Black Diamond Shimmer (215 SHIM)
 Blue Zircon (229)
 Blue Zircon Shimmer (229 SHIM)
 Blush Rose (257)
 Capri Blue (243)
 Capri Blue Nightfall (243 1051)
 Crystal (001)
 Crystal Shimmer (001 SHIM)
 Crystal Aurore Boreale (001 AB)
 Crystal Blue Shade (001 BLSH)
 Crystal Creampearl (001 291)
 Crystal Dark Grey Pearl (001 617)
 Crystal Dusty Pink DeLite (001 L149D)
 Crystal Electric Blue (001 L134S)
 Crystal Electric Green (001 L135S)
 Crystal Electric Orange (001 L136S)
 Crystal Electric Pink (001 L137S)
 Crystal Electric Violet (001 L148S)
 Crystal Electric White (001 L139S)
 Crystal Electric Yellow (001 L138S)
 Crystal Golden Shadow (001 GSHA)
 Crystal Hotfix Transparent (001 HFT)²
 Crystal Ivory Cream DeLite (001 L106D)
 Crystal Laguna DeLite (001 L142D)
 Crystal Lavender DeLite (001 L144D)
 Crystal Light Chrome (001 LTCH)
 Crystal Lotus Pink DeLite (001 L145D)
 Crystal Metallic Sunshine (001METSH)
 Crystal Moonlight (001 MOL)
 Crystal Nacre (001 191)
 Crystal Ocean DeLite (001 L143D)

Crystal Orange Glow DeLite (001 L146D)
 Crystal Paradise Shine (001 PARSH)
 Crystal Rosaline Pearl (001 294)
 Crystal Rose Gold (001 ROGL)
 Crystal Royal Blue DeLite (001 L110D)
 Crystal Royal Red DeLite (001 L107D)
 Crystal Serene Gray DeLite (001 L150D)
 Crystal Silky Sage DeLite (001 L147D)
 Crystal Silver Night (001 SINI)
 Crystal Silver Shade (001 SSHA)
 Crystal Transmission Hotfix Transparent (001 TRA HFT)
 Crystal Volcano (001 VOL)
 Crystal White Pearl (001 650)
 Denim Blue (266)
 Emerald (205)
 Emerald Nightfall (205 1051)
 Erinite (360)
 Fuchsia (502)
 Fuchsia Shimmer (502 SHIM)
 Golden Topaz (1003)
 Graphite (253)
 Graphite Nightfall (253 1051)
 Greige (284)
 Indian Siam (327)²
 Iris (219)
 Jet (280)
 Jet Aurore Boreale (280 AB)
 Jet Hematite (280 HEM)
 Jet Light Chrome Z (280 LTCHZ)
 Jonquil (213)
 Jonquil Aurore Boreale (213 AB)
 Light Amber (1002)
 Light Amethyst (212)
 Light Colorado Topaz (246)
 Light Peach (362)

Light Rose (223)
 Light Rose Aurore Boreale (223 AB)
 Light Rose Shimmer (223 SHIM)
 Light Sapphire (211)
 Light Sapphire Shimmer (211 SHIM)
 Light Siam (227)
 Light Siam Aurore Boreale (227 AB)
 Light Siam Light Chrome Z (227 LTCHZ)
 Light Siam Shimmer (227 SHIM)
 Light Silk (261)
 Light Topaz (226)
 Light Turquoise (263)
 Majestic Blue (296)¹
 Montana (207)
 Padparadscha (542)
 Peridot (214)
 Peridot Shimmer (214 SHIM)
 Rose (209)
 Ruby (501)
 Sapphire (206)
 Sapphire Aurore Boreale (206 AB)
 Scarlet (276)
 Siam (208)
 Siam Nightfall (208 1051)
 Silk (391)
 Silk Shimmer (391 SHIM)
 Smoked Amber (1001)
 Tanzanite (539)
 Tanzanite Shimmer (539 SHIM)
 Topaz (203)
 Topaz Shimmer (203 SHIM)
 Vintage Rose (319)
 White Opal (234)

For details on available colors and effects for each article within the product groups, please see the product matrix of the respective item in the Collection 2021. For color and effect samples, please see the corresponding color chart.

The plating resistance of effects is tested according to Swarovski's plating guidelines (SWAROVSKI.COM/S-PROFESSIONALS). Customers are advised to carry out their own tests if their plating parameters diverge from Swarovski plating guidelines.

¹ Majestic Blue's intense ultramarine hue is difficult to recreate accurately in print due to the fact that the CMYK color spectrum is used in the printing process. In order to get a truer impression of its color, please use RGB digital pictures or, ideally, ask for actual samples.

² Only available in limited sizes.

Classic Colors/Effects: This color range offers a wide choice of traditional Swarovski crystal colors and effects.

Exclusive Colors/Effects: This color range is offered exclusively by Swarovski.

Colors and effects can appear different when illuminated with different light sources. Swarovski uses standard light source D50 for color decision and comparison. Slight changes in shades are unavoidable. Colors may vary according to cut and foiling.

The composition of Advanced Crystal is compliant with regulatory industry norms and laws regarding the restriction or prohibition of certain substances in the most relevant segments of our customers. Please note that the compliance of the crystal colors Light Siam and Siam varies according to certain industry regulations. Those regulations are indicated with * in the compliance overview. Indian Siam and Scarlet (option to Lt. Siam) conform to all CLEAR-lists. For further information please visit swarovski.com/s-professionals

Summary

1 2



2000 A HF
SS 3

CORE ASSORTMENT



2038 A HF
SS 5, 6, 8, 10



2038/1 A HF
SS 10

CORE ASSORTMENT



2078 A HF
SS 12, 16, 20, 30, 34,
40, 48



2078/1 A HF
SS 16, 20



2080/4 HF
SS 10, 16, 34

CORE ASSORTMENT



2200 M HF
4x2, 8x4 mm



2201 M HF
8x3.5, 14x6 mm



2205 M HF
7.5, 10, 14 mm

CORE ASSORTMENT



2300 M HF
8x4.8 mm

1 2



2303 M HF
8x5, 14x9 mm



2304 M HF
10x2.8 mm



2364 M HF
6x3.7, 10x6, 14x8.5 mm



2365 M HF
6x3.7, 10x6, 14x8.5 mm

CORE ASSORTMENT



2400 M HF
2.2, 3, 4, 6 mm



2471 M HF
5, 7, 10 mm



2472 M HF
5, 7, 10 mm



2510 M HF
3.7x1.9, 5x2.5 mm



2555 M HF
8x2.6, 12x4 mm



2602 M HF
8x5.5, 14x10 mm

1 2



2603 M HF
4x3, 8x6, 14x10 mm



2709 M HF
10x6 mm



2715 M HF
3, 4, 6 mm



2716 M HF
5 mm



2738 M HF
10x5, 12x6 mm



2739 M HF
5.8x5.3, 7x6.5 mm



2740 M HF
8.3x8.3, 10x10 mm



2770 M HF
6x3.5 mm



2771 M HF
6.4x4.2, 8.6x5.6,
12.9x8.3 mm



2772 M HF
6.5x2.1, 8.6x2.8,
12.9x4.2 mm

1 2



2773 M HF
5x3, 6.6x3.9,
9.9x5.9 mm

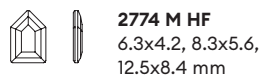

2774 M HF
6.3x4.2, 8.3x5.6,
12.5x8.4 mm

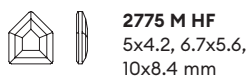

2775 M HF
5x4.2, 6.7x5.6,
10x8.4 mm

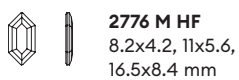

2776 M HF
8.2x4.2, 11x5.6,
16.5x8.4 mm



2777 M HF
5x4.2, 6.7x5.6,
10x8.4 mm



2788 M HF
8, 10 mm



2808 M HF
3.6, 6, 10 mm



2813 M HF
8x5.5 mm

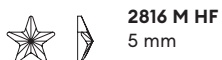

2816 M HF
5 mm

2000 Rose Hoflix

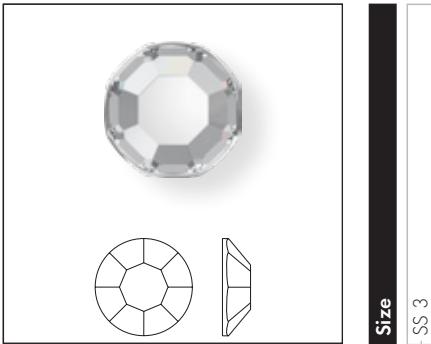

- Crystal**
- Crystal A HF (001)
- Colors**
- Plain Colors**
- Aquamarine A HF (202)
- Black Diamond A HF (215)
- Golden Topaz A HF (1003)*
- Jet A HF (280)
- Light Amber A HF (1002)*
- Light Colorado Topaz A HF (246)
- Light Rose A HF (223)
- Montana A HF (207)
- Smoked Amber A HF (1001)*
- Crystal Effects**
- Transparent Effects**
- Crystal Aurore Boreale A HF (001 AB)
- Crystal Golden Shadow A HF (001 GSHA)
- Crystal Silver Shade A HF (001 SSHA)
- Color Effects**
- Metallic Effects**
- Jet Hematite A HF (280 HEM)

* All colors with a 4-digit color code (i.e. Golden Topaz) are fully customizable with shorter lead times and lower MOQs compared to our 3-digit colors. Please get in touch with the Customer Service for a time and quantity estimation of your desired variant.

CORE ASSORTMENT

2038 XILION Rose Hotfix

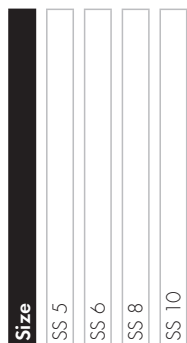
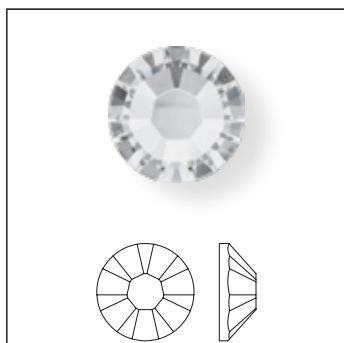

Crystal

- Crystal Hotfix Transparent (001 HFT)
- Crystal A HF (001)

Colors

Plain Colors

- Amethyst A HF (204)
- Aquamarine A HF (202)
- Black Diamond A HF (215)
- Blue Zircon A HF (229)
- Blush Rose A HF (257)
- Capri Blue A HF (243)
- Denim Blue A HF (266)
- Emerald A HF (205)
- Erinite A HF (360)
- Fuchsia A HF (502)
- Golden Topaz A HF (1003)*
- Graphite A HF (253)
- Greige A HF (284)
- Indian Siam A HF (327)
- Iris A HF (219)
- Jet A HF (280)
- Jonquil A HF (213)
- Light Amber A HF (1002)*
- Light Amethyst A HF (212)
- Light Colorado Topaz A HF (246)
- Light Peach A HF (362)
- Light Rose A HF (223)
- Light Sapphire A HF (211)
- Light Siam A HF (227)
- Light Silk A HF (261)
- Light Topaz A HF (226)
- Light Turquoise A HF (263)
- Majestic Blue A HF (296)

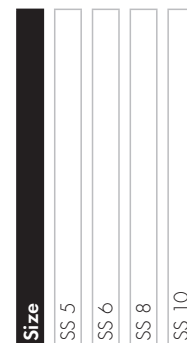
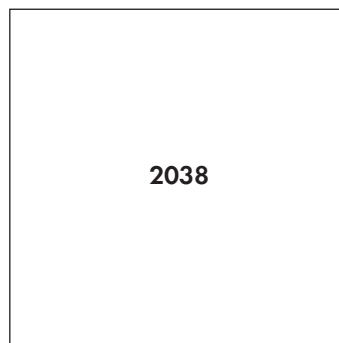

- Montana A HF (207)
 - Padparadscha A HF (542)
 - Peridot A HF (214)
 - Rose A HF (209)
 - Ruby A HF (501)
 - Sapphire A HF (206)
 - Scarlet A HF (276)
 - Siam A HF (208)
 - Silk A HF (391)
 - Smoked Amber A HF (1001)*
 - Tanzanite A HF (539)
 - Topaz A HF (203)
 - Vintage Rose A HF (319)
- Opal Colors**
- White Opal A HF (234)
- Crystal Effects**
- Transparent Effects**
- Crystal Aurore Boreale A HF (001 AB)
 - Crystal Blue Shade A HF (001 BLSH)
 - Crystal Golden Shadow A HF (001 GSHA)
 - Crystal Moonlight A HF (001 MOL)
 - Crystal Paradise Shine A HF (001 PARSH)
 - Crystal Shimmer A HF (001 SHIM)
 - Crystal Silver Night A HF (001 SINI)
 - Crystal Silver Shade A HF (001 SSHA)
 - Crystal Transmission HFT (001 TRA HFT)
 - Crystal Volcano A HF (001 VOL)
- Metallic Effects**
- Crystal Light Chrome A HF (001 LTCH)
 - Crystal Metallic Sunshine A HF (001 METSH)
 - Crystal Rose Gold A HF (001 ROGL)

07

* All colors with a 4-digit color code (i.e. Golden Topaz) are fully customizable with shorter lead times and lower MOQs compared to our 3-digit colors. Please get in touch with the Customer Service for a time and quantity estimation of your desired variant.

◆ Core Assortment

2038		Size	SS 5	SS 6	SS 8	SS 10
Crystal Lacquer^{PRO} Effects						
Crystal Shiny Lacquer^{PRO} Effects						
	Crystal Electric Blue HFT (001 L134S)					■
	Crystal Electric Green HFT (001 L135S)					■
	Crystal Electric Orange HFT (001 L136S)					■
	Crystal Electric Pink HFT (001 L137S)					■
	Crystal Electric Violet HFT (001 L148S)					■
	Crystal Electric White HFT (001 L139S)					■
	Crystal Electric Yellow HFT (001 L138S)					■
Crystal Lacquer^{PRO} DeLite Effects						
	Crystal Dusty Pink DeLite HFT (001 L149D)					■
	Crystal Ivory Cream DeLite HFT (001 L106D)					■
	Crystal Laguna DeLite HFT (001 L142D)					■
	Crystal Lavender DeLite HFT (001 L144D)					■
	Crystal Lotus Pink DeLite HFT (001 L145D)					■
	Crystal Ocean DeLite HFT (001 L143D)					■
	Crystal Orange Glow DeLite HFT (001 L146D)					■
	Crystal Royal Blue DeLite HFT (001 L110D)					■
	Crystal Royal Red DeLite HFT (001 L107D)					■
	Crystal Serene Gray DeLite HFT (001 L150D)					■
	Crystal Silky Sage DeLite HFT (001 L147D)					■
Color Effects						
Transparent Effects						
	Black Diamond Shimmer A HF (215 SHIM)		■			■
	Blue Zircon Shimmer A HF (229 SHIM)		■			■
	Capri Blue Nightfall A HF (243 1051)		■			■
	Emerald Nightfall A HF (205 1051)		■			■
	Fuchsia Shimmer A HF (502 SHIM)		■			■
	Graphite Nightfall A HF (253 1051)		■			■
	Jet Aurore Boreale A HF (280 AB)		■	■		■
	Jonquil Aurore Boreale A HF (213 AB)		■	■		■
	Light Rose Aurore Boreale A HF (223 AB)		■	■		■
	Light Rose Shimmer A HF (223 SHIM)		■			■
	Light Sapphire Shimmer A HF (211 SHIM)		■			■

2038		Size	SS 5	SS 6	SS 8	SS 10
	Light Siam Aurore Boreale A HF (227 AB)			■	■	■
	Light Siam Shimmer A HF (227 SHIM)			■		■
	Peridot Shimmer A HF (214 SHIM)			■		■
	Sapphire Aurore Boreale A HF (206 AB)			■	■	■
	Siam Nightfall A HF (208 1051)			■		■
	Silk Shimmer A HF (391 SHIM)			■		■
	Tanzanite Shimmer A HF (539 SHIM)			■		■
	Topaz Shimmer A HF (203 SHIM)			■		■
Metallic Effects						
	Jet Hematite A HF (280 HEM)			■	■	■

* All colors with a 4-digit color code (i.e. Golden Topaz) are fully customizable with shorter lead times and lower MOQs compared to our 3-digit colors. Please get in touch with the Customer Service for a time and quantity estimation of your desired variant.

2038/I Rimmed Flat Back

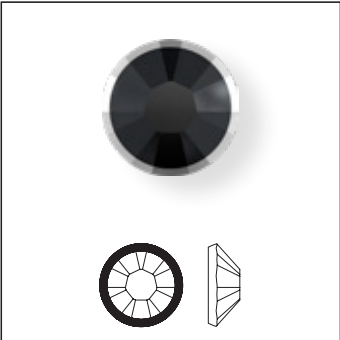

Size
SS 10

Color Effects

Metallic Effects

Jet & Light Chrome Z A HF (280 ITCHZ)

CORE ASSORTMENT

2078 XIRIUS Rose Hotfix

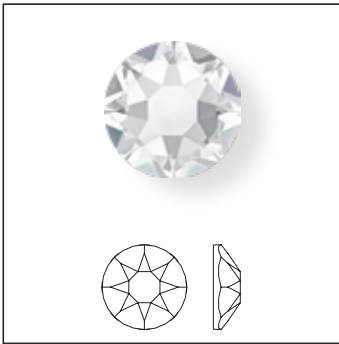

Size	SS 12	SS 16	SS 20	SS 30	SS 34	SS 40	SS 48
------	-------	-------	-------	-------	-------	-------	-------

Crystal

- Crystal Hotfix Transparent (001 HFT)
- Crystal A HF (001)

Colors

Plain Colors

- Amethyst A HF (204)
- Aquamarine A HF (202)
- Black Diamond A HF (215)
- Blue Zircon A HF (229)
- Blush Rose A HF (257)
- Capri Blue A HF (243)
- Denim Blue A HF (266)
- Emerald A HF (205)
- Erinite A HF (360)
- Fuchsia A HF (502)
- Golden Topaz A HF (1003)*
- Graphite A HF (253)
- Greige A HF (284)
- Indian Siam A HF (327)
- Iris A HF (219)
- Jet A HF (280)
- Jonquil A HF (213)
- Light Amber A HF (1002)*
- Light Amethyst A HF (212)
- Light Colorado Topaz A HF (246)
- Light Peach A HF (362)
- Light Rose A HF (223)
- Light Sapphire A HF (211)
- Light Siam A HF (227)
- Light Silk A HF (261)
- Light Topaz A HF (226)
- Light Turquoise A HF (263)
- Majestic Blue A HF (296)

Crystal Hotfix Transparent (001 HFT)		■					
Crystal A HF (001)	◆	◆	◆	◆	◆	◆	◆
Amethyst A HF (204)	◆	◆	◆		◆		
Aquamarine A HF (202)	◆	◆	◆		◆		
Black Diamond A HF (215)	■	■	■		■		
Blue Zircon A HF (229)	■	■	■		■		
Blush Rose A HF (257)	■	■	■		■		
Capri Blue A HF (243)	■	■	■		■		
Denim Blue A HF (266)	■	■	■		■		
Emerald A HF (205)	◆	◆	◆		◆		
Erinite A HF (360)	■	■	■		■		
Fuchsia A HF (502)	■	■	■		■		
Golden Topaz A HF (1003)*	■	■	■		■		
Graphite A HF (253)	■	■	■		■		
Greige A HF (284)	■	■	■		■		
Indian Siam A HF (327)	■	■	■		■		
Iris A HF (219)	■	■	■		■		
Jet A HF (280)	◆	◆	◆	■	◆		
Jonquil A HF (213)	■	■	■		■		
Light Amber A HF (1002)*	■	■	■		■		
Light Amethyst A HF (212)	■	■	■		■		
Light Colorado Topaz A HF (246)	◆	◆	◆		◆		
Light Peach A HF (362)	■	■	■		■		
Light Rose A HF (223)	◆	◆	◆		◆		
Light Sapphire A HF (211)	■	■	■		■		
Light Siam A HF (227)	■	■	■		■		
Light Silk A HF (261)	■	■	■		■		
Light Topaz A HF (226)	■	■	■		■		
Light Turquoise A HF (263)	■	■	■		■		
Majestic Blue A HF (296)	■	■	■		■		

* All colors with a 4-digit color code (i.e. Golden Topaz) are fully customizable with shorter lead times and lower MOQs compared to our 3-digit colors. Please get in touch with the Customer Service for a time and quantity estimation of your desired variant.

◆ Core Assortment

2078		Size						
		SS 12	SS 16	SS 20	SS 30	SS 34	SS 40	SS 48
Montana A HF (207)		■	■	■		■		
Padparadscha A HF (542)		■	■	■		■		
Peridot A HF (214)		■	■	■		■		
Rose A HF (209)		■	■	■		■		
Ruby A HF (501)		■	■	■		■		
Sapphire A HF (206)		■	■	■		■		
Scarlet A HF (276)		◆	◆	◆		◆		
Siam A HF (208)		■	■	■		■		
Silk A HF (391)		■	■	■		■		
Smoked Amber A HF (1001)*		■	■	■		■		
Tanzanite A HF (539)		■	■	■		■		
Topaz A HF (203)		■	■	■		■		
Vintage Rose A HF (319)		■	■	■		■		
Opal Colors								
White Opal A HF (234)		■	■	■		■		
Crystal Effects								
Transparent Effects								
Crystal Aurore Boreale A HF (001 AB)		■	■	■	■	■	■	■
Crystal Blue Shade A HF (001 BLSH)		■	■	■		■		
Crystal Golden Shadow A HF (001 GSHA)		■	■	■		■		
Crystal Moonlight A HF (001 MOL)		■	■	■		■		
Crystal Paradise Shine A HF (001 PARSH)		■	■	■		■		
Crystal Shimmer A HF (001 SHIM)			■	■		■		
Crystal Silver Night A HF (001 SINI)		■	■	■		■		
Crystal Silver Shade A HF (001 SSHA)		■	■	■		■		
Crystal Transmission HFT (001 TRA HFT)		■	■	■		■		
Crystal Volcano A HF (001 VOL)		■	■	■		■		
Metallic Effects								
Crystal Light Chrome A HF (001 LTCH)		■	■	■		■		
Crystal Metallic Sunshine A HF (001 METSH)		■	■	■		■		
Crystal Rose Gold A HF (001 ROGL)		■	■	■		■		

* All colors with a 4-digit color code (i.e. Golden Topaz) are fully customizable with shorter lead times and lower MOQs compared to our 3-digit colors. Please get in touch with the Customer Service for a time and quantity estimation of your desired variant.

◆ Core Assortment

2078		Size	SS 12	SS 16	SS 20	SS 30	SS 34	SS 40	SS 48
Crystal Lacquer^{PRO} Effects									
Crystal Shiny Lacquer^{PRO} Effects									
	Crystal Electric Blue HFT (001 L134S)		■	■			■		
	Crystal Electric Green HFT (001 L135S)		■	■			■		
	Crystal Electric Orange HFT (001 L136S)		■	■			■		
	Crystal Electric Pink HFT (001 L137S)		■	■			■		
	Crystal Electric Violet HFT (001 L148S)		■	■			■		
	Crystal Electric White HFT (001 L139S)		■	■			■		
	Crystal Electric Yellow HFT (001 L138S)		■	■			■		
Crystal Lacquer^{PRO} DeLite Effects									
	Crystal Dusty Pink DeLite HFT (001 L149D)		■	■			■		
	Crystal Ivory Cream DeLite HFT (001 L106D)		■	■			■		
	Crystal Laguna DeLite HFT (001 L142D)		■				■		
	Crystal Lavender DeLite HFT (001 L144D)		■				■		
	Crystal Lotus Pink DeLite HFT (001 L145D)		■				■		
	Crystal Ocean DeLite HFT (001 L143D)		■				■		
	Crystal Orange Glow DeLite HFT (001 L146D)		■				■		
	Crystal Royal Blue DeLite HFT (001 L110D)		■				■		
	Crystal Royal Red DeLite HFT (001 L107D)		■				■		
	Crystal Serene Gray DeLite HFT (001 L150D)		■	■			■		
	Crystal Silky Sage DeLite HFT (001 L147D)		■				■		
Color Effects									
Transparent Effects									
	Black Diamond Shimmer A HF (215 SHIM)			■	■			■	
	Blue Zircon Shimmer A HF (229 SHIM)			■	■			■	
	Capri Blue Nightfall A HF (243 1051)			■	■			■	
	Emerald Nightfall A HF (205 1051)			■	■			■	
	Fuchsia Shimmer A HF (502 SHIM)			■	■			■	
	Graphite Nightfall A HF (253 1051)			■	■			■	
	Jet Aurore Boreale A HF (280 AB)		■	■	■			■	
	Jonquil Aurore Boreale A HF (213 AB)		■	■	■			■	
	Light Rose Aurore Boreale A HF (223 AB)		■	■	■			■	
	Light Rose Shimmer A HF (223 SHIM)			■	■			■	

* All colors with a 4-digit color code (i.e. Golden Topaz) are fully customizable with shorter lead times and lower MOQs compared to our 3-digit colors. Please get in touch with the Customer Service for a time and quantity estimation of your desired variant.

2078		Size	SS 12	SS 16	SS 20	SS 30	SS 34	SS 40	SS 48
	Light Sapphire Shimmer A HF (211 SHIM)			■	■				
	Light Siam Aurore Boreale A HF (227 AB)		■	■	■		■		
	Light Siam Shimmer A HF (227 SHIM)			■	■		■		
	Peridot Shimmer A HF (214 SHIM)			■	■		■		
	Sapphire Aurore Boreale A HF (206 AB)		■	■	■		■		
	Siam Nightfall A HF (208 1051)			■	■		■		
	Silk Shimmer A HF (391 SHIM)			■	■		■		
	Tanzanite Shimmer A HF (539 SHIM)			■	■		■		
	Topaz Shimmer A HF (203 SHIM)			■	■		■		
Metallic Effects									
	Jet Hematite A HF (280 HEM)		■	■	■		■		

2078/I Rimmed Flat Back

2078/I Rimmed Flat Back		Size	SS 16	SS 20
	Color Effects			
Metallic Effects				
	Jet & Light Chrome Z A HF (280 LTCHZ)		■	■
	Light Siam & Light Chrome Z A HF (227 LTCHZ)		■	■

CABOCHON

2080/4 Cabochon



Size	SS 10	SS 16	SS 34
------	-------	-------	-------

Colors

Plain Colors

● Jet M HF (280)

Crystal Pearl Colors

● Crystal Nacre HF (001 191)

● Crystal Creampearl HF (001 291)

● Crystal Dark Grey Pearl HF (001 617)

● Crystal Rosaline Pearl HF (001 294)

● Crystal White Pearl HF (001 650)

Crystal Effects

Transparent Effects

● Crystal Golden Shadow HF (001 GSHA)

Crystal Color Effects

Metallic Effects

● Jet Hematite M HF (280 HEM)

Jet M HF (280)	■	■	■
Crystal Nacre HF (001 191)	■	■	■
Crystal Creampearl HF (001 291)	■	■	■
Crystal Dark Grey Pearl HF (001 617)	■	■	■
Crystal Rosaline Pearl HF (001 294)	■	■	■
Crystal White Pearl HF (001 650)	■	■	■
Crystal Golden Shadow HF (001 GSHA)	■	■	■
Jet Hematite M HF (280 HEM)	■	■	■

2200 Navette Flat Back

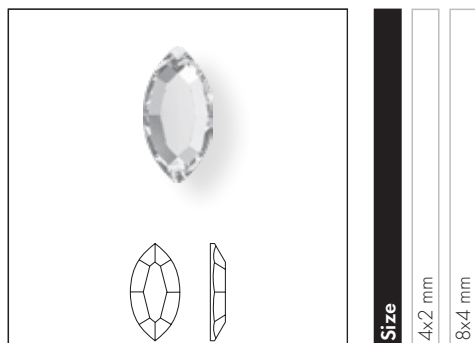

Size
4x2 mm
8x4 mm

Crystal

Crystal M HF (001)

Crystal Effects

Transparent Effects

Crystal Aurore Boreale M HF (001 AB)

Crystal Golden Shadow M HF (001 GSHA)

Crystal Silver Shade M HF (001 SSHA)

2201 Marquise Flat Back

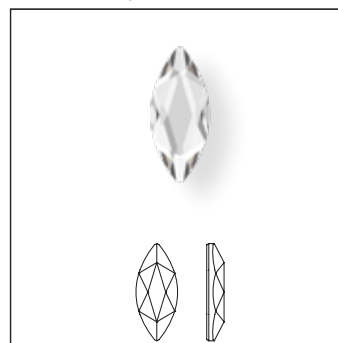

Size
8x3.5 mm
14x6 mm

Crystal

Crystal M HF (001)

Crystal Effects

Transparent Effects

Crystal Aurore Boreale M HF (001 AB)

Crystal Golden Shadow M HF (001 GSHA)

2205 Flame Flat Back

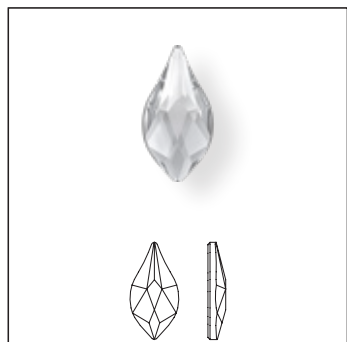

Size
7.5 mm
10 mm
14 mm

Crystal

Crystal M HF (001)

Crystal Effects

Transparent Effects

Crystal Aurore Boreale M HF (001 AB)

Crystal Golden Shadow M HF (001 GSHA)

2300 Drop Flat Back



Size
8x4.8 mm

Crystal

Crystal M HF (001)

Crystal Effects

Transparent Effects

Crystal Aurore Boreale M HF (001 AB)

Crystal Golden Shadow M HF (001 GSHA)

2303 Pear Flat Back

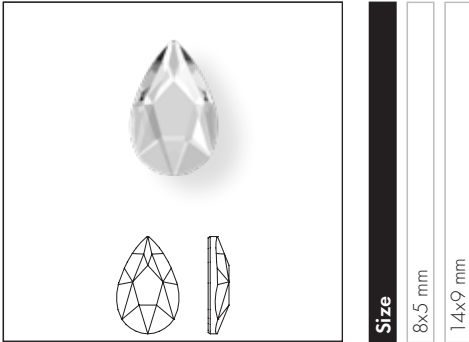

Size

8x5 mm

14x9 mm

Crystal

Crystal M HF (001)

Crystal Effects

Transparent Effects

Crystal Aurore Boreale M HF (001 AB)

Crystal Golden Shadow M HF (001 GSHA)

2304 Raindrop Flat Back

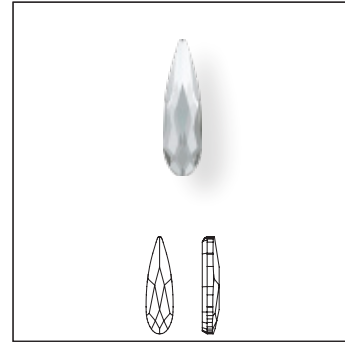

Size

10x2.8 mm

Crystal

Crystal M HF (001)

Crystal Effects

Transparent Effects

Crystal Aurore Boreale M HF (001 AB)

Crystal Golden Shadow M HF (001 GSHA)

Crystal Silver Night M HF (001 SINI)

PAISLEY FLAT BACKS

2364 Paisley X Flat Back



Size

6x3.7 mm

10x6 mm

14x8.5 mm

Crystal

Crystal M HF (001)

Colors

Plain Colors

Jet M HF (280)

Light Colorado Topaz M HF (246)

Majestic Blue M HF (296)

Scarlet M HF (276)

Crystal Effects

Transparent Effects

Crystal Aurore Boreale M HF (001 AB)

Crystal Golden Shadow M HF (001 GSHA)

Crystal Silver Night M HF (001 SINI)

Crystal Silver Shade M HF (001 SSHA)

2365 Paisley Y Flat Back



Size

6x3.7 mm

10x6 mm

14x8.5 mm

Crystal

Crystal M HF (001)

Colors

Plain Colors

Jet M HF (280)

Light Colorado Topaz M HF (246)

Majestic Blue M HF (296)

Scarlet M HF (276)

Crystal Effects

Transparent Effects

Crystal Aurore Boreale M HF (001 AB)

Crystal Golden Shadow M HF (001 GSHA)

Crystal Silver Night M HF (001 SINI)

Crystal Silver Shade M HF (001 SSHA)

CORE ASSORTMENT

2400 Square Flat Back

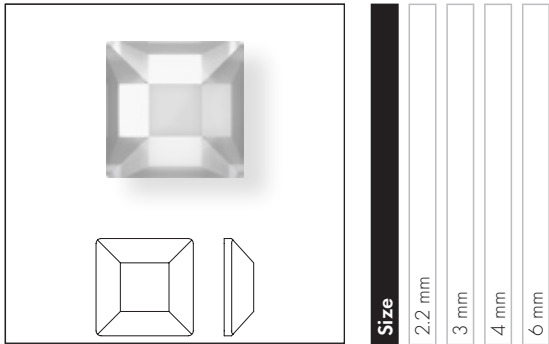

Size
2.2 mm
3 mm
4 mm
6 mm

Crystal

Crystal M HF (001)

Colors

Plain Colors

Amethyst M HF (204)

Aquamarine M HF (202)

Emerald M HF (205)

Jet M HF (280)

Light Colorado Topaz M HF (246)

Light Rose M HF (223)

Scarlet M HF (276)

Crystal Effects

Transparent Effects

Crystal Aurore Boreale M HF (001 AB)

Crystal Golden Shadow M HF (001 GSHA)

Crystal Silver Night M HF (001 SINI)

Metallic Effects

Crystal Light Chrome M HF (001 LTCH)

Color Effects

Metallic Effects

Jet Hematite M HF (280 HEM)

2471 Cushion Flat Back

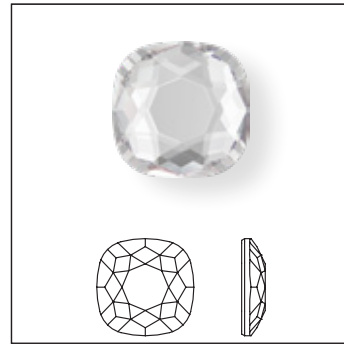

Size
5 mm
7 mm
10 mm

Crystal

Crystal M HF (001)

Colors

Plain Colors

Aquamarine M HF (202)

Emerald M HF (205)

Graphite M HF (253)

Jet M HF (280)

Sapphire M HF (206)

Scarlet M HF (276)

Vintage Rose M HF (319)

Crystal Effects

Transparent Effects

Crystal Aurore Boreale M HF (001 AB)

Crystal Golden Shadow M HF (001 GSHA)

2472 Trilliant Flat Back



Size
5 mm
7 mm
10 mm

- Crystal**
- Crystal M HF (001)
- Colors**
- Plain Colors**
- Aquamarine M HF (202)
- Emerald M HF (205)
- Graphite M HF (253)
- Jet M HF (280)
- Scarlet M HF (276)
- Sapphire M HF (206)
- Vintage Rose M HF (319)
- Crystal Effects**
- Transparent Effects**
- Crystal AB M HF (001 AB)
- Crystal Golden Shadow M HF (001 GSHA)

2510 Baguette Flat Back

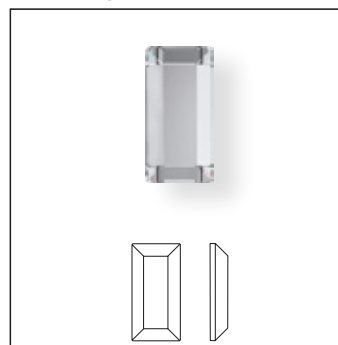

Size
3.7x1.9 mm
5x2.5 mm

- Crystal**
- Crystal M HF (001)
- Colors**
- Plain Colors**
- Jet M HF (280)
- Crystal Effects**
- Transparent Effects**
- Crystal Aurore Boreale M HF (001 AB)
- Crystal Golden Shadow M HF (001 GSHA)
- Color Effects**
- Metallic Effects**
- Jet Hematite M HF (280 HEM)

2555 Cosmic Baguette Flat Back

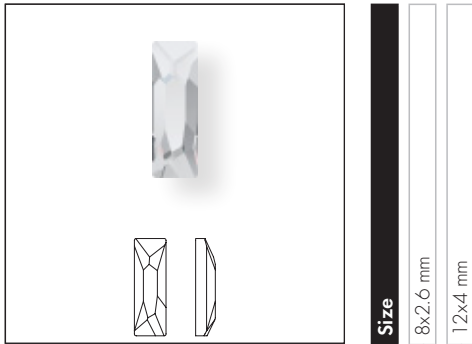

Size
8x2.6 mm
12x4 mm

Crystal

Crystal M HF (001)

Crystal Effects

Transparent Effects

Crystal Aurore Boreale M HF (001 AB)

Crystal Golden Shadow M HF (001 GSHA)

2602 Emerald Cut Flat Back

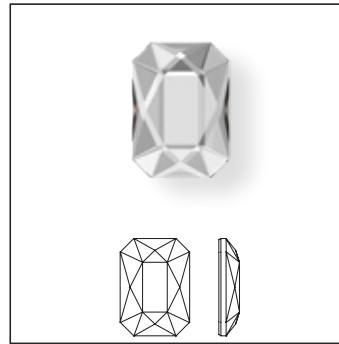

Size
8x5.5 mm
14x10 mm

Crystal

Crystal M HF (001)

Crystal Effects

Transparent Effects

Crystal Aurore Boreale M HF (001 AB)

Crystal Golden Shadow M HF (001 GSHA)

2603 Oval Flat Back



Size
4x3 mm
8x6 mm
14x10 mm

Crystal

Crystal M HF (001)

Colors

Plain Colors

Aquamarine M HF (202)

Emerald M HF (205)

Graphite M HF (253)

Jet M HF (280)

Scarlet M HF (276)

Sapphire M HF (206)

Vintage Rose M HF (319)

Crystal Effects

Transparent Effects

Crystal AB M HF (001 AB)

Crystal Golden Shadow M HF (001 GSHA)

2709 Rhombus Flat Back

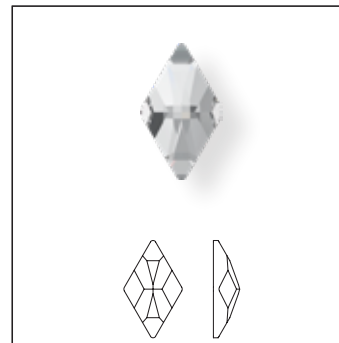

Size
10x6 mm

Crystal

Crystal M HF (001)

Crystal Effects

Transparent Effects

Crystal Aurore Boreale M HF (001 AB)

Crystal Golden Shadow M HF (001 GSHA)

2715 Connector Flat Back

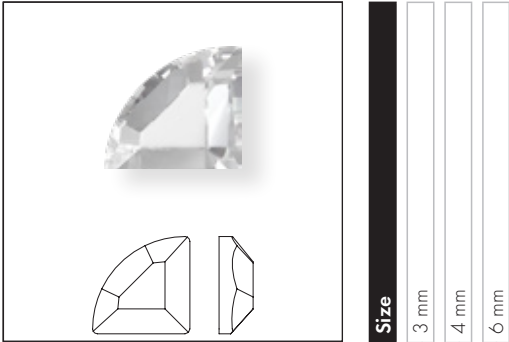

Size
3 mm
4 mm
6 mm

Crystal			
Crystal M HF (001)	■	■	■
Colors			
Plain Colors			
Amethyst M HF (204)	■	■	
Aquamarine M HF (202)	■	■	
Emerald M HF (205)	■	■	
Jet M HF (280)	■	■	■
Light Colorado Topaz M HF (246)	■	■	
Scarlet M HF (276)	■	■	
Crystal Effects			
Transparent Effects			
Crystal Aurore Boreale M HF (001 AB)	■	■	■
Crystal Golden Shadow M HF (001 GSHA)	■	■	■
Crystal Silver Night M HF (001 SINI)		■	■
Metallic Effects			
Crystal Light Chrome M HF (001 LTCH)	■	■	■
Color Effects			
Metallic Effects			
Jet Hematite M HF (280 HEM)	■	■	■

2716 Rivoli Triangle Flat Back

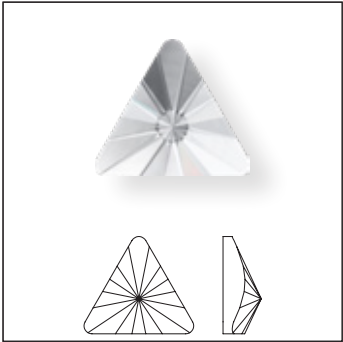

Size
5 mm

Crystal	
Crystal M HF (001)	■
Crystal Effects	
Transparent Effects	
Crystal Aurore Boreale M HF (001 AB)	■

TRIANGLE FAMILY

2738 Triangle Alpha Flat Back

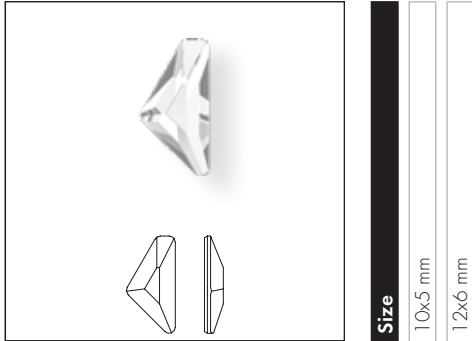

Size

10x5 mm

12x6 mm

Crystal

Crystal M HF (001)

Crystal Effects

Transparent Effects

Crystal Aurore Boreale M HF (001 AB)

Crystal Golden Shadow M HF (001 GSHA)

Crystal Silver Night M HF (001 SINI)

2739 Triangle Beta Flat Back



Size

5.8x5.3 mm

7x6.5 mm

Crystal

Crystal M HF (001)

Crystal Effects

Transparent Effects

Crystal Aurore Boreale M HF (001 AB)

Crystal Golden Shadow M HF (001 GSHA)

Crystal Silver Night M HF (001 SINI)

2740 Triangle Gamma Flat Back

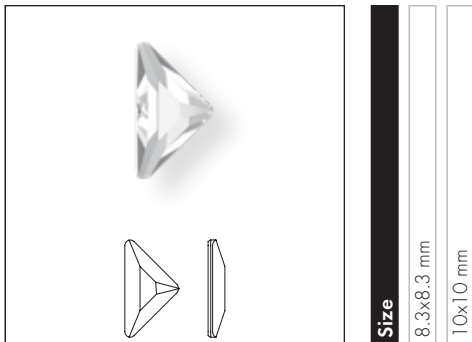

Size

8.3x8.3 mm

10x10 mm

Crystal

Crystal M HF (001)

Crystal Effects

Transparent Effects

Crystal Aurore Boreale M HF (001 AB)

Crystal Golden Shadow M HF (001 GSHA)

Crystal Silver Night M HF (001 SINI)

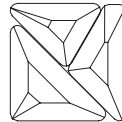

When Alpha, Beta, and Gamma Flat Backs are arranged together, they form a square.

2770 Wing Flat Back

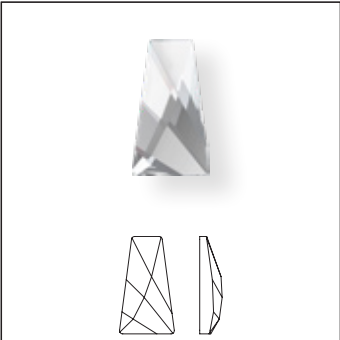

Size
6x3.5 mm

Crystal

Crystal M HF (001)

Crystal Effects

Transparent Effects

Crystal Aurore Boreale M HF (001 AB)

GEOMETRIC FLAT BACKS

2771 Kite Flat Back

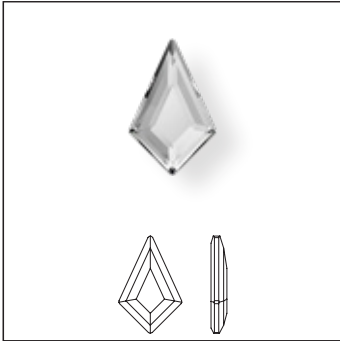

Size
6.4x4.2 mm
8.6x5.6 mm
12.9x8.3 mm

Crystal
Crystal M HF (001)
Colors
Plain Colors
Black Diamond M HF (215)
Light Rose M HF (223)
Light Siam M HF (227)
Crystal Effects
Transparent Effects
Crystal Aurore Boreale M HF (001 AB)
Crystal Golden Shadow M HF (001 GSHA)
Color Effects
Metallic Effects
Jet Hematite M HF (280 HEM)

2772 Trapeze Flat Back

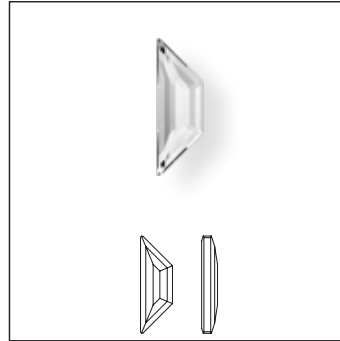

Size
6.5x2.1 mm
8.6x2.8 mm
12.9x4.2 mm

Crystal
Crystal M HF (001)
Colors
Plain Colors
Black Diamond M HF (215)
Crystal Effects
Transparent Effects
Crystal Aurore Boreale M HF (001 AB)
Crystal Golden Shadow M HF (001 GSHA)
Color Effects
Metallic Effects
Jet Hematite M HF (280 HEM)

2773 Diamond Shape Flat Back

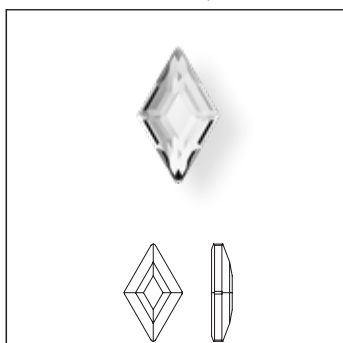

Size
5x3 mm
6.6x3.9 mm
9.9x5.9 mm

- Crystal**
- Crystal M HF (001)
- Colors**
- Plain Colors**
- Black Diamond M HF (215)
- Light Rose M HF (223)
- Light Siam M HF (227)
- Crystal Effects**
- Transparent Effects**
- Crystal Aurore Boreale M HF (001 AB)
- Crystal Golden Shadow M HF (001 GSHA)
- Color Effects**
- Metallic Effects**
- Jet Hematite M HF (280 HEM)

2774 Elongated Pentagon Flat Back

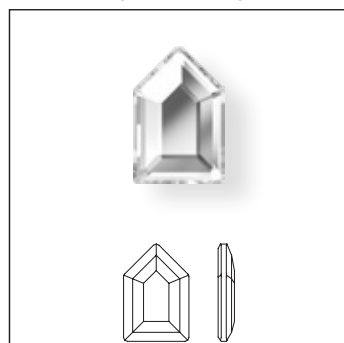

Size
6.3x4.2 mm
8.3x5.6 mm
12.5x8.4 mm

- Crystal**
- Crystal M HF (001)
- Colors**
- Plain Colors**
- Black Diamond M HF (215)
- Light Siam M HF (227)
- Crystal Effects**
- Transparent Effects**
- Crystal Aurore Boreale M HF (001 AB)
- Color Effects**
- Metallic Effects**
- Jet Hematite M HF (280 HEM)

2775 Concise Pentagon Flat Back

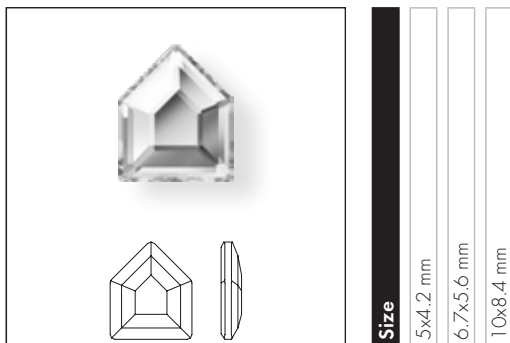

Size

5x4.2 mm

6.7x5.6 mm

10x8.4 mm

Crystal

Crystal M HF (001)

Colors

Plain Colors

Black Diamond M HF (215)

Light Siam M HF (227)

Crystal Effects

Transparent Effects

Crystal Aurore Boreale M HF (001 AB)

Color Effects

Metallic Effects

Jet Hematite M HF (280 HEM)

2776 Elongated Hexagon Flat Back

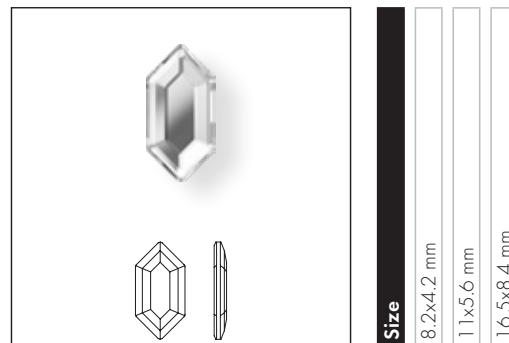

Size

8.2x4.2 mm

11x5.6 mm

16.5x8.4 mm

Crystal

Crystal M HF (001)

Colors

Plain Colors

Black Diamond M HF (215)

Light Siam M HF (227)

Crystal Effects

Transparent Effects

Crystal Aurore Boreale M HF (001 AB)

Color Effects

Metallic Effects

Jet Hematite M HF (280 HEM)

2777 Concise Hexagon Flat Back

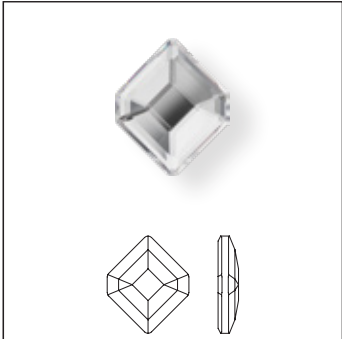

Size
5x4.2 mm
6.7x5.6 mm
10x8.4 mm

- Crystal**
- Crystal M HF (001)
- Colors**
- Plain Colors**
- Black Diamond M HF (215)
- Light Siam M HF (227)
- Crystal Effects**
- Transparent Effects**
- Crystal Aurore Boreale M HF (001 AB)
- Color Effects**
- Metallic Effects**
- Jet Hematite M HF (280 HEM)

2788 Wave Flat Back

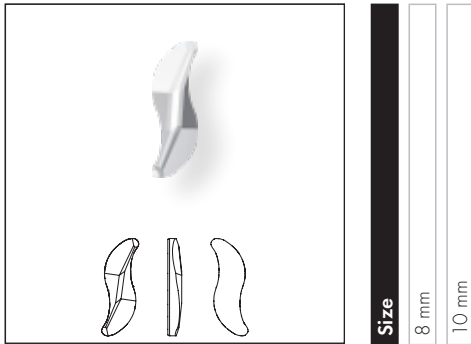

Size
8 mm
10 mm

Crystal

Crystal M HF (001)

Crystal Effects

Transparent Effects

Crystal Aurore Boreale M HF (001 AB)

2808 Heart Flat Back

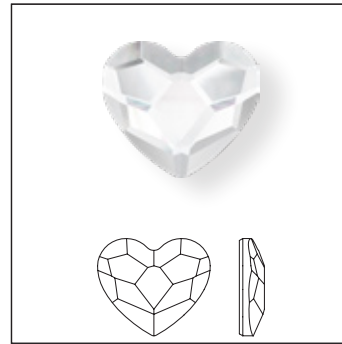

Size
3.6 mm
6 mm
10 mm

Crystal

Crystal M HF (001)

Colors

Plain Colors

Fuchsia M HF (502)

Jet M HF (280)

Light Siam M HF (227)

Crystal Effects

Transparent Effects

Crystal Aurore Boreale M HF (001 AB)

Crystal Golden Shadow M HF (001 GSHA)

2813 Moon Flat Back Halfix



Size
8x5.5 mm

Crystal

Crystal M HF (001)

Crystal Effects

Transparent Effects

Crystal Aurore Boreale M HF (001 AB)

2816 Rivoli Star Flat Back

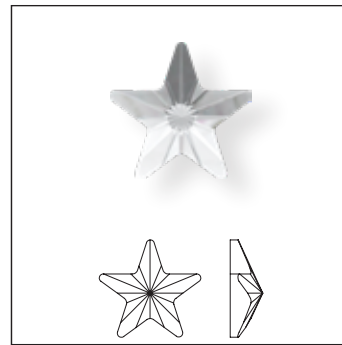

Size
5 mm

Crystal

Crystal M HF (001)

Colors

Plain Colors

Jet M HF (280)

Crystal Effects

Transparent Effects

Crystal Aurore Boreale M HF (001 AB)

Color Effects

Metallic Effects

Jet Hematite M HF (280 HEM)

Product Details

Article Size	Packing Unit = Minimum Order Quantity in Pieces	Average Net Weight in Gram per Packing Unit Crystal (001)	Average Gross Weight in Gram per Packing Unit Crystal (001)
2000 A HF			
SS 3	1,440	1.8	12.7
2038 A HF			
SS 5	1,440	4.2	12.1
SS 6	1,440	5.4	17.7
SS 8	1,440	9.96	18.2
SS 10	1,440	15.54	24.3
2038/I			
SS 10	1440	15.7	24.4
2078 A HF			
SS 12	1,440	21.6	30.4
SS 16	1,440	39.1	47.1
SS 20	1,440	72.0	79.6
SS 30	288	34.6	63.0
SS 34	144	26.0	48.6
SS 40	144	43.2	66.9
SS 48	96	61.4	87.4
2078/I A HF			
SS 16	1,440	39.1	47.1
SS 20	1,440	72.0	79.6
2080/4 HF			
SS 10	1,440	17.1	28.3
SS 16	1,440	43.4	54.9
SS 34	144	23.2	34.1
2200 M HF			
4x2 mm	720	6.5	18.5
8x4 mm	360	24.8	35.8
2201 M HF			
8x3.5 mm	144	10.03	31.11
14x6 mm	72	21.67	45.27
2205 M HF			
7.5 mm	288	20.3	30.5
10 mm	144	17.6	42.4
14 mm	72	22.3	45.9
2300 M HF			
8x4.8 mm	360	41.9	51.0
2303 M HF			
8x5 mm	144	15.70	39.60
14x9 mm	72	36.65	60.25
2304 M HF			
10x2.8 mm	180	10.2	20.4
2364			
6x3.7 mm	288	13.9	37.1
10x6 mm	72	14.8	37.9
14x8.5 mm	72	34.9	59.7

Article Size	Packing Unit = Minimum Order Quantity in Pieces	Average Net Weight in Gram per Packing Unit Crystal (001)	Average Gross Weight in Gram per Packing Unit Crystal (001)
2365 M HF			
6x3.7 mm	288	13.9	37.0
10x7 mm	72	14.8	37.9
14x8.5 mm	72	34.9	59.7
2400 M HF			
2.2 mm	1,440	9.65	18.5
3 mm	1,440	25.3	36.8
4 mm	720	30.0	41.0
6 mm	144	21.9	32.7
2471 M HF			
5 mm	288	17.3	25.6
7 mm	72	11.9	35.1
10 mm	72	30.2	51.6
2472 M HF			
5 mm	288	17.4	27.6
7 mm	144	20.8	42.8
10 mm	96	34.5	56.5
2510 M HF			
3.7x1.9 mm	720	8.2	10.6
5x2.5 mm	720	23.2	32.3
2555 M HF			
8x2.6 mm	240	18.4	27.5
12x4 mm	144	28.8	33.6
2602 M HF			
8x5.5 mm	144	17.89	41.79
14x10 mm	72	58.61	82.21
2603 M HF			
4x3 mm	288	6.8	17.0
8x6 mm	144	21.7	43.7
14x10 mm	72	50.3	72.3
2709 M HF			
10x6 mm	288	28.9	67.2
2715 M HF			
3 mm	288	4.0	14.2
4 mm	288	8.2	18.4
6 mm	144	18.4	28.6
2716 M HF			
5 mm	720	35.8	75.1
2738 M HF			
10x5 mm	144	16.7	35.1
12x6 mm	96	20.2	38.3
2739 M HF			
5.8x5.3 mm	216	19.2	41.9
7x6.5 mm	144	22.6	39.8

Article Size	Packing Unit = Minimum Order Quantity in Pieces	Average Net Weight in Gram per Packing Unit Crystal (001)	Average Gross Weight in Gram per Packing Unit Crystal (001)
2740 M HF			
8.3x8.3 mm	216	35.1	54.2
10x10 mm	96	25.1	41.1
2770 M HF			
6x3.5 mm	1,440	60.3	70.3
2771 M HF			
6.4x4.2 mm	288	9.04	17.87
8.6x5.6 mm	216	16.84	43.02
12.9x8.3 mm	144	36.29	61.39
2772 M HF			
6.5x2.1 mm	288	6.39	15.17
8.6x2.8 mm	288	16.29	40.71
12.9x4.2 mm	144	25.57	53.86
2773 M HF			
5x3 mm	288	4.83	13.66
6.6x3.9 mm	288	11.23	35.65
9.9x5.9 mm	144	19.30	43.39
2774 M HF			
6.3x4.2 mm	288	18.7	29.6
8.3x5.6 mm	144	19.5	39.4
12.5x8.4 mm	96	39.0	60.3
2775 M HF			
5x4.2 mm	288	13.9	24.7
6.7x5.6 mm	144	15.0	34.3
10x8.4 mm	144	43.6	66.4
2776 M HF			
8.2x4.2 mm	144	11.2	30.1
11x5.6 mm	72	11.3	28.8
16.5x8.4 mm	72	35.6	55.8
2777 M HF			
5x4.2 mm	288	10.4	21.3
6.7x5.6 mm	144	10.5	29.7
10x8.4 mm	144	32.8	52.7
2788 M HF			
8 mm	288	7.5	18.4
10 mm	216	10.5	37.7
2808 M HF			
3.6 mm	720	18.4	20.8
6 mm	288	19.8	28.9
10 mm	144	38.8	55.9
2813 M HF			
8x5.5 mm	144	13.1	37.7
2816 M HF			
5 mm	720	23.6	30.7