

Flat Backs No Hotfix























Flat Backs No Hotfix are loose crystal elements backed with platinum foiling for extra brilliance and protection. These Flat Backs are easy to apply to a variety of carrier materials using standard one or two component glues. They are available in a multitude of sizes, colors, shapes and cuts.





















The most innovative single item in this product group is art 2088 XIRIUS Rose, with the most progressive and unique cut on the market multilayer cut technology creates the inspiring XIRIUS star design. Superior shine and rich, well balanced refraction of light redefine the market standard.

Swarovski's outstanding quality in crystal elements is underlined by the highest precision in table size and diameter.

Colors & Effects

Colors

-  Crystal
001
-  White Opal
234
-  Light Silk
261
-  Silk
391
-  Light Peach
362
-  Vintage Rose
319
-  Light Rose
223
-  Rose
209
-  Blush Rose
257
-  Padparadscha
542
-  Light Siam
227
-  Scarlet
276
-  Indian Siam²
327
-  Ruby
501
-  Siam
208
-  Fuchsia
502
-  Amethyst
204
-  Iris
219
-  Light Amethyst
212
-  Tanzanite
539
-  Light Sapphire
211
-  Aquamarine
202

-  Sapphire
206
-  Capri Blue
243
-  Majestic Blue¹
296
-  Montana
207
-  Light Turquoise
263
-  Blue Zircon
229
-  Denim Blue
266
-  Black Diamond
215
-  Peridot
214
-  Erinite
360
-  Emerald
205
-  Greige
284
-  Light Colorado Topaz
246
-  Jonquil
213
-  Light Topaz
226
-  Golden Topaz
1003
-  Topaz
203
-  Light Amber
1002
-  Smoked Amber
1001
-  Graphite
253
-  Jet³
280

Effects







-  Crystal Silver Shade
001 SSHA
-  Crystal Moonlight
001 MOL
-  Crystal Aurore Boreale
001 AB
-  Crystal Shimmer
001 SHIM
-  Crystal Golden Shadow
001 GSHA
-  Crystal Metallic Sunshine*
001 METSH
-  Crystal Rose Gold*
001 ROGL
-  Crystal Antique Pink*
001 ANTP
-  Crystal Volcano**
001 VOL
-  Crystal Paradise Shine*
001 PARSH
-  Crystal Blue Shade*
001 BLSH
-  Crystal Light Chrome*
001 LTCH
-  Crystal Comet Argent Light*
001 CAL
-  Crystal Silver Night**
001 SINI
-  Jet Hematite*/³
280 HEM

Crystal Lacquer^{Pro} Effects

Crystal Lacquer^{Pro} DeLite Effects

-  Crystal Ivory Cream DeLite*
001 L106D
-  Crystal Orange Glow DeLite*
001 L146D
-  Crystal Lotus Pink DeLite*
001 L145D
-  Crystal Royal Red DeLite*
001 L107D
-  Crystal Dusty Pink DeLite*
001 L149D
-  Crystal Lavender DeLite*
001 L144D
-  Crystal Ocean DeLite*
001 L143D
-  Crystal Royal Blue DeLite*
001 L110D
-  Crystal Laguna DeLite*
001 L142D
-  Crystal Silky Sage DeLite*
001 L147D
-  Crystal Serene Gray DeLite*
001 L150D





Crystal Electric Lacquer^{Pro} Effects

-  Crystal Electric White*
001 L139S
-  Crystal Electric Orange*
001 L136S
-  Crystal Electric Pink*
001 L137S
-  Crystal Electric Violet*
001 L148S
-  Crystal Electric Blue*
001 L134S
-  Crystal Electric Green*
001 L135S
-  Crystal Electric Yellow*
001 L138S

Shimmer Effects

-  Silk Shimmer
391 SHIM
-  Vintage Rose Shimmer
319 SHIM
-  Light Rose Shimmer
223 SHIM
-  Light Siam Shimmer
227 SHIM
-  Scarlet Shimmer
276 SHIM
-  Fuchsia Shimmer
502 SHIM
-  Tanzanite Shimmer
539 SHIM
-  Light Sapphire Shimmer
211 SHIM
-  Cobalt Shimmer
369 SHIM
-  Aquamarine Shimmer
202 SHIM
-  Blue Zircon Shimmer
229 SHIM
-  Black Diamond Shimmer
215 SHIM
-  Peridot Shimmer
214 SHIM
-  Light Topaz Shimmer
226 SHIM
-  Topaz Shimmer
203 SHIM



AB Effects

-  Light Siam Aurore Boreale
227 AB
-  Light Rose Aurore Boreale
223 AB
-  Sapphire Aurore Boreale
206 AB
-  Jonquil Aurore Boreale
213 AB

Nightfall Effects

-  Siam Nightfall
208 NIFA
-  Capri Blue Nightfall
243 NIFA
-  Emerald Nightfall
205 NIFA
-  Graphite Nightfall
253 NIFA

Cabochons

-  Crystal Peony Pink*
001 L113S
-  Crystal Mint Green*
001 L115S
-  Crystal Ocean DeLite*
001 L143D
-  Crystal Golden Shadow
001 GSHA
-  Crystal Powder Grey
001 L105A
-  Crystal Satin Tapak
001 SATTA
-  Crystal Satin Moroda
001 SATMO

Numerical Order

001	Crystal	001 SINI	<u>Crystal Silver Night**</u>	229 SHIM	<u>Blue Zircon Shimmer</u>
001 AB	<u>Crystal Aurore Boreale</u>	001 SSHA	<u>Crystal Silver Shade</u>	234	<u>White Opal</u>
001 ANTP	<u>Crystal Antique Pink*</u>	001 VOL	<u>Crystal Volcano**</u>	243	<u>Capri Blue</u>
001 BLSH	<u>Crystal Blue Shade*</u>	202	<u>Aquamarine</u>	<u>243 NIFA</u>	<u>Capri Blue Nightfall</u>
001 CAL	<u>Crystal Comet Argent Light*</u>	202 SHIM	<u>Aquamarine Shimmer</u>	246	<u>Light Colorado Topaz</u>
001 GSHA	<u>Crystal Golden Shadow</u>	203	<u>Topaz</u>	253	<u>Graphite</u>
001 LI05A	<u>Crystal Powder Grey</u>	203 SHIM	<u>Topaz Shimmer</u>	<u>253 NIFA</u>	<u>Graphite Nightfall</u>
001 LI06D	<u>Crystal Ivory Cream DeLite*</u>	204	<u>Amethyst</u>	257	<u>Blush Rose</u>
001 LI07D	<u>Crystal Royal Red DeLite*</u>	205	<u>Emerald</u>	261	<u>Light Silk</u>
001 LI10D	<u>Crystal Royal Blue DeLite*</u>	<u>205 NIFA</u>	<u>Emerald Nightfall</u>	263	<u>Light Turquoise</u>
001 LI13S	<u>Crystal Peony Pink*</u>	206	<u>Sapphire</u>	266	<u>Denim Blue</u>
001 LI15S	<u>Crystal Mint Green*</u>	206 AB	<u>Sapphire Aurore Boreale</u>	276	<u>Scarlet</u>
001 LI34S	<u>Crystal Electric Blue*</u>	207	<u>Montana</u>	276 SHIM	<u>Scarlet Shimmer</u>
001 LI35S	<u>Crystal Electric Green*</u>	208	<u>Siam</u>	280	<u>Jet³</u>
001 LI36S	<u>Crystal Electric Orange*</u>	<u>208 NIFA</u>	<u>Siam Nightfall</u>	280 HEM	<u>Jet Hematite*/³</u>
001 LI37S	<u>Crystal Electric Pink*</u>	209	<u>Rose</u>	284	<u>Greige</u>
001 LI38S	<u>Crystal Electric Yellow*</u>	211	<u>Light Sapphire</u>	296	<u>Majestic Blue¹</u>
001 LI39S	<u>Crystal Electric White*</u>	211 SHIM	<u>Light Sapphire Shimmer</u>	319	<u>Vintage Rose</u>
001 LI42D	<u>Crystal Laguna DeLite*</u>	212	<u>Light Amethyst</u>	<u>319 SHIM</u>	<u>Vintage Rose Shimmer</u>
001 LI43D	<u>Crystal Ocean DeLite*</u>	213	<u>Jonquil</u>	327	<u>Indian Siam²</u>
001 LI44D	<u>Crystal Lavender DeLite*</u>	213 AB	<u>Jonquil Aurore Boreale</u>	360	<u>Erinite</u>
001 LI45D	<u>Crystal Lotus Pink DeLite*</u>	214	<u>Peridot</u>	362	<u>Light Peach</u>
001 LI46D	<u>Crystal Orange Glow DeLite*</u>	214 SHIM	<u>Peridot Shimmer</u>	369 SHIM	<u>Cobalt Shimmer</u>
001 LI47D	<u>Crystal Silky Sage DeLite*</u>	215	<u>Black Diamond</u>	391	<u>Silk</u>
001 LI48S	<u>Crystal Electric Violet*</u>	215 SHIM	<u>Black Diamond Shimmer</u>	391 SHIM	<u>Silk Shimmer</u>
001 LI49D	<u>Crystal Dusty Pink DeLite*</u>	219	<u>Iris</u>	501	<u>Ruby</u>
001 LI50D	<u>Crystal Serene Gray DeLite*</u>	223	<u>Light Rose</u>	502	<u>Fuchsia</u>
001 LTCH	<u>Crystal Light Chrome*</u>	223 AB	<u>Light Rose Aurore Boreale</u>	502 SHIM	<u>Fuchsia Shimmer</u>
001 METSH	<u>Crystal Metallic Sunshine*</u>	223 SHIM	<u>Light Rose Shimmer</u>	539	<u>Tanzanite</u>
001 MOL	<u>Crystal Moonlight</u>	226	<u>Light Topaz</u>	539 SHIM	<u>Tanzanite Shimmer</u>
001 PARSH	<u>Crystal Paradise Shine*</u>	226 SHIM	<u>Light Topaz Shimmer</u>	<u>542</u>	<u>Padparadscha</u>
001 ROGL	<u>Crystal Rose Gold*</u>	227	<u>Light Siam</u>	<u>1001</u>	<u>Smoked Amber</u>
001 SATMO	<u>Crystal Satin Morada</u>	227 AB	<u>Light Siam Aurore Boreale</u>	<u>1002</u>	<u>Light Amber</u>
001 SATTA	<u>Crystal Satin Tapak</u>	227 SHIM	<u>Light Siam Shimmer</u>	<u>1003</u>	<u>Golden Topaz</u>
001 SHIM	<u>Crystal Shimmer</u>	229	<u>Blue Zircon</u>		

Alphabetical Order

Amethyst (204)
 Aquamarine (202)
 Aquamarine Shimmer (202 SHIM)
 Black Diamond (215)
 Black Diamond Shimmer (215 SHIM)
 Blue Zircon (229)
 Blue Zircon Shimmer (229 SHIM)
 Blush Rose (257)
 Capri Blue (243)
 Capri Blue Nightfall (243 NIFA)
 Cobalt Shimmer (369 SHIM)
 Crystal (001)
 Crystal Antique Pink (001 ANTP)*
 Crystal Aurore Boreale (001 AB)
 Crystal Blue Shade (001 BLSH)*
 Crystal Comet Argent Light (001 CAL)*
 Crystal Dusty Pink DeLite (001 L149D)*
 Crystal Electric Blue (001 L134S)*
 Crystal Electric Green (001 L135S)*
 Crystal Electric Orange (001 L136S)*
 Crystal Electric Pink (001 L137S)*
 Crystal Electric Violet (001 L148S)*
 Crystal Electric White (001 L139S)*
 Crystal Electric Yellow (001 L138S)*
 Crystal Golden Shadow (001 GSHA)
 Crystal Ivory Cream DeLite (001 L106D)*
 Crystal Laguna DeLite (001 L142D)*
 Crystal Lavender DeLite (001 L144D)*
 Crystal Light Chrome (001 LTCH)*
 Crystal Lotus Pink DeLite (001 L145D)*
 Crystal Metallic Sunshine (001 METSH)*
 Crystal Mint Green (001 L115S)*
 Crystal Moonlight (001 MOL)
 Crystal Ocean DeLite (001 L143D)*
 Crystal Orange Glow DeLite (001 L146D)*

Crystal Paradise Shine (001 PARSH)*
 Crystal Peony Pink (001 L113S)*
 Crystal Powder Grey (001 L105A)
 Crystal Rose Gold (001 ROGL)*
 Crystal Royal Blue DeLite (001 L110D)*
 Crystal Royal Red DeLite (001 L107D)*
 Crystal Satin Moroda (001 SATMO)
 Crystal Satin Tapak (001 SATTA)
 Crystal Serene Gray DeLite (001 L150D)*
 Crystal Shimmer (001 SHIM)
 Crystal Silky Sage DeLite (001 L147D)*
 Crystal Silver Night (001 SINI)**
 Crystal Silver Shade (001 SSHA)
 Crystal Volcano (001 VOL)**
 Denim Blue (266)
 Emerald (205)
 Emerald Nightfall (205 NIFA)
 Erinite (360)
 Fuchsia (502)
 Fuchsia Shimmer (502 SHIM)
 Golden Topaz (1003)
 Graphite (253)
 Graphite Nightfall (253 NIFA)
 Greige (284)
 Indian Siam (327)²
 Iris (219)
 Jet (280)³
 Jet Hematite (280 HEM)*³
 Jonquil (213)
 Jonquil Aurore Boreale (213 AB)
 Light Amber (1002)
 Light Amethyst (212)
 Light Colorado Topaz (246)
 Light Peach (362)
 Light Rose (223)

Light Rose Aurore Boreale (223 AB)
 Light Rose Shimmer (223 SHIM)
 Light Sapphire (211)
 Light Sapphire Shimmer (211 SHIM)
 Light Siam (227)
 Light Siam Aurore Boreale (227 AB)
 Light Siam Shimmer (227 SHIM)
 Light Silk (261)
 Light Topaz (226)
 Light Topaz Shimmer (226 SHIM)
 Light Turquoise (263)
 Majestic Blue (296)¹
 Montana (207)
 Padparadscha (542)
 Peridot (214)
 Peridot Shimmer (214 SHIM)
 Rose (209)
 Ruby (501)
 Sapphire (206)
 Sapphire Aurore Boreale (206 AB)
 Scarlet (276)
 Scarlet Shimmer (276 SHIM)
 Siam (208)
 Siam Nightfall (208 NIFA)
 Silk (391)
 Silk Shimmer (391 SHIM)
 Smoked Amber (1001)
 Tanzanite (539)
 Tanzanite Shimmer (539 SHIM)
 Topaz (203)
 Topaz Shimmer (203 SHIM)
 Vintage Rose (319)
 Vintage Rose Shimmer (319 SHIM)
 White Opal (234)

For details on available colors and effects for each article within the product groups, please see the product matrix of the respective item in the Collection 2021. For color and effect samples, please see the corresponding color chart.

The plating resistance of effects is tested according to Swarovski's plating guidelines (SWAROVSKI.COM/S-PROFESSIONALS). Customers are advised to carry out their own tests if their plating parameters diverge from Swarovski plating guidelines.

* Crystals are not resistant to plating and similar processing.

** Crystals are resistant to plating only if they are F-foiled.

¹ Majestic Blue's intense ultramarine hue is difficult to recreate accurately in print due to the fact that the CMYK color spectrum is used in the printing process. In order to get a truer impression of its color, please use RGB digital pictures or, ideally, ask for actual samples.

² Only available in limited sizes.

³ In these colors art. 2088 is available as a foiled or unfoiled version.

Classic Colors/Effects: This color range offers a wide choice of traditional Swarovski crystal colors and effects.

Exclusive Colors/Effects: This color range is offered exclusively by Swarovski.

Colors and effects can appear different when illuminated with different light sources. Swarovski uses standard light source D50 for color decision and comparison. Slight changes in shades are unavoidable. Colors may vary according to cut and foiling.

The composition of Advanced Crystal is compliant with regulatory industry norms and laws regarding the restriction or prohibition of certain substances in the most relevant segments of our customers. Please note that the compliance of the crystal colors Light Siam and Siam varies according to certain industry regulations. Those regulations are indicated with * in the compliance overview. Indian Siam and Scarlet (option to Lt. Siam) conform to all CLEAR-lists. For further information please visit swarovski.com/s-professionals

© 2021 D. Swarovski Distribution GmbH

Summary

1 2  2000 SS 3, 4	1 2  2304 6x1.7, 10x2.8, 14x3.9 mm	1 2  2602 8x5.5, 14x10 mm
 2019 4x4, 5x5, 6x6 mm	 2364 6x3.7, 10x6, 14x8.5 mm	 2603 4x3, 8x6, 14x10 mm
 2035 6, 10, 14, 20, 30, 40 mm	 2365 6x3.7, 10x6, 14x8.5 mm	 2709 10x6, 13x8 mm
CORE ASSORTMENT  2058 SS 5, 6, 7, 8, 9, 10	CORE ASSORTMENT  2400 2.2, 3, 4, 6 mm	 2711 3.3 mm
 2072 8, 10, 12 mm	 2471 5, 7, 10 mm	 2715 3, 4, 6 mm
CORE ASSORTMENT  2088 SS 12, 14, 16, 20, 24, 30, 34, 40, 48	 2472 5, 7, 10 mm	 2716 5 mm
 2196/4 30x22.7 mm	 2483 10, 25 mm	 2738 10x5, 12x6 mm
CORE ASSORTMENT  2200 4x2, 8x4 mm	 2493 8, 10, 20 mm	 2739 5.8x5.3, 7x6.5 mm
 2201 8x3.5, 14x6 mm	 2510 3.7x1.9 mm	 2740 8.3x8.3, 10x10 mm
 2205 7.5, 10, 14 mm	 2520 8x6, 10x8, 14x10 mm	 2770 6x3.5, 12x7 mm
CORE ASSORTMENT  2300 8x4.8, 10x6 mm	 2555 8x2.6, 12x4, 15x5 mm	 2771 6.4x4.2, 8.6x5.6, 12.9x8.3 mm
 2303 8x5, 14x9 mm	 2585 8, 10 mm	 2772 6.5x2.1, 8.6x2.8, 12.9x4.2 mm

1 Top view 2 Side view

1 2



2773
5x3, 6.6x3.9,
9.9x5.9 mm



2774
6.3x4.2, 8.3x5.6,
12.5x8.4 mm



2775
5x4.2, 6.7x5.6,
10x8.4 mm



2776
8.2x4.2, 11x5.6,
16.5x8.4 mm



2777
5x4.2, 6.7x5.6,
10x8.4 mm



2808
3.6, 6, 10, 14 mm



2813
8x5.5 mm



2816
5 mm



2854
8, 12 mm



2856
10x7.5, 14x10.5, 18x14 mm

2000 Rose Flat Back

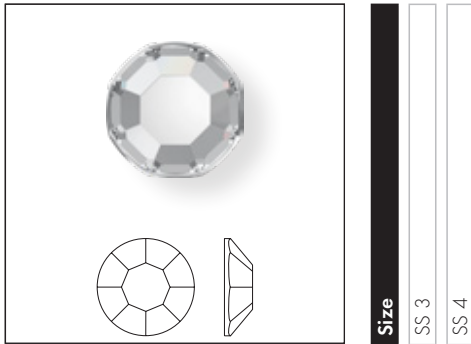

Size
SS 3
SS 4

Crystal	
Crystal F (001)	■ ■
Colors	
Plain Colors	
Aquamarine F (202)	■ ■
Black Diamond F (215)	■ ■
Golden Topaz F (1003)*	■ ■
Indian Siam F (327)	■ ■
Jet (280)	■ ■
Light Amber F (1002)*	■ ■
Light Colorado Topaz F (246)	■ ■
Light Rose F (223)	■ ■
Smoked Amber F (1001)*	■ ■
Crystal Effects	
Transparent Effects	
Crystal Aurore Boreale F (001 AB)	■ ■ ■
Crystal Golden Shadow F (001 GSHA)	■ ■
Metallic Effects	
Crystal Rose Gold F (001 ROGL)	■ ■
Color Effects	
Metallic Effects	
Jet Hematite F (280 HEM)	■ ■

2019 Round Spike Flat Back

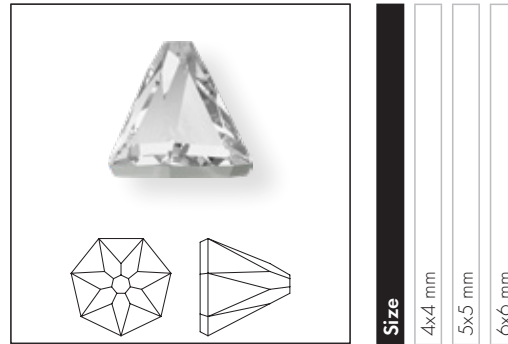

Size
4x4 mm
5x5 mm
6x6 mm

Crystal	
Crystal F (001)	■ ■ ■
Crystal Effects	
Transparent Effects	
Crystal Aurore Boreale F (001 AB)	■ ■ ■
Crystal Blue Shade F (001 BLSH)	■ ■ ■
Crystal Golden Shadow F (001 GSHA)	■ ■ ■
Crystal Volcano F (001 VOL)	■ ■ ■
Color Effects	
Transparent Effects	
Black Diamond Shimmer F (215 SHIM)	■ ■ ■
Light Topaz Shimmer F (226 SHIM)	■ ■ ■

* All colors with a 4-digit color code (i.e. Golden Topaz) are fully customizable with shorter lead times and lower MOQs compared to our 3-digit colors. Please get in touch with the Customer Service for a time and quantity estimation of your desired variant.

2035 Chessboard Circle Flat Back

	6 mm	10 mm	14 mm	20 mm	30 mm	40 mm
Crystal						
Crystal F (001)	■	■	■	■	■	■
Colors						
Plain Colors						
Jet (280)	■	■	■	■		
Crystal Effects						
Transparent Effects						
Crystal Aurore Boreale F (001 AB)	■	■				
Color Effects						
Metallic Effects						
Crystal Comet Argent Light V SI (001 CAVSI) ¹				■	■	■

¹ Coated on faceted side.

CORE ASSORTMENT

2058 XILION Rose Enhanced

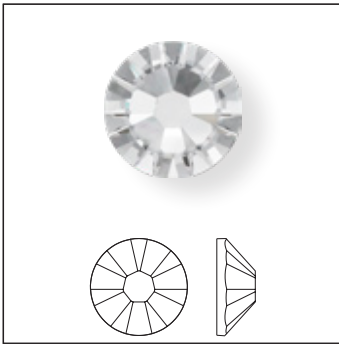

Size	SS 5	SS 6	SS 7	SS 8	SS 9	SS 10
------	------	------	------	------	------	-------

Crystal

Crystal F (001)	◆	■	◆	■	◆	■
-----------------	---	---	---	---	---	---

Colors

Plain Colors

Amethyst F (204)	◆		◆		◆	
Aquamarine F (202)	◆		◆		◆	
Black Diamond F (215)	■		■		■	
Blue Zircon F (229)	■		■		■	
Blush Rose F (257)	■		■		■	
Capri Blue F (243)	■		■		■	
Denim Blue F (266)	■		■		■	
Emerald F (205)	◆		◆		◆	
Erinite F (360)	■		■		■	
Fuchsia F (502)	■		■		■	
Golden Topaz F (1003)*	■		■		■	
Graphite F (253)	■		■		■	
Greige F (284)	■		■		■	
Indian Siam F (327)	■		■		■	
Iris F (219)	■		■		■	
Jet F (280)	◆	■	◆	■	◆	■
Jonquil F (213)	■		■		■	
Light Amber F (1002)*	■		■		■	
Light Amethyst F (212)	■		■		■	
Light Colorado Topaz F (246)	◆		◆		◆	
Light Peach F (362)	■		■		■	
Light Rose F (223)	◆		◆		◆	
Light Sapphire F (211)	■		■		■	
Light Siam F (227)	■		■		■	
Light Silk F (261)	■		■		■	
Light Topaz F (226)	■		■		■	
Light Turquoise F (263)	■		■		■	
Majestic Blue F (296)	■		■		■	
Montana F (207)	■		■		■	
Padparadscha F (542)	■		■		■	
Peridot F (214)	■		■		■	













* All colors with a 4-digit color code (i.e. Golden Topaz) are fully customizable with shorter lead times and lower MOQs compared to our 3-digit colors. Please get in touch with the Customer Service for a time and quantity estimation of your desired variant.

◆ Core Assortment

2058		Size	SS 5	SS 6	SS 7	SS 8	SS 9	SS 10
	Rose F (209)		■		■		■	
	Ruby F (501)		■		■		■	
	Sapphire F (206)		■		■		■	
	Scarlet F (276)		◆		◆		◆	
	Siam F (208)		■		■		■	
	Silk F (391)		■		■		■	
	Smoked Amber F (1001)*		■		■		■	
	Tanzanite F (539)		■		■		■	
	Topaz F (203)		■		■		■	
	Vintage Rose F (319)		■		■		■	
Opal Colors								
	White Opal F (234)		■		■		■	
Crystal Effects								
Transparent Effects								
	Crystal Aurore Boreale F (001 AB)		■	■	■	■	■	■
	Crystal Blue Shade F (001 BLSH)		■		■		■	
	Crystal Golden Shadow F (001 GSHA)		■		■		■	
	Crystal Moonlight F (001 MOL)		■		■		■	
	Crystal Paradise Shine F (001 PARSH)		■		■		■	
	Crystal Shimmer F (001 SHIM)		■		■		■	
	Crystal Silver Night F (001 SINI)		■		■		■	
	Crystal Silver Shade F (001 SSHA)		■		■		■	
	Crystal Volcano F (001 VOL)		■		■		■	
Metallic Effects								
	Crystal Light Chrome F (001 LTCH)		■		■		■	
	Crystal Metallic Sunshine F (001 METSH)		■		■		■	
	Crystal Rose Gold F (001 ROGL)		■		■		■	
Color Effects								
Transparent Effects								
	Black Diamond Shimmer F (215 SHIM)		■				■	
	Blue Zircon Shimmer F (229 SHIM)		■				■	
	Capri Blue Nightfall F (243 NIFA)		■				■	
	Emerald Nightfall F (205 NIFA)		■				■	
	Fuchsia Shimmer F (502 SHIM)		■				■	
	Graphite Nightfall F (253 NIFA)		■				■	

* All colors with a 4-digit color code (i.e. Golden Topaz) are fully customizable with shorter lead times and lower MOQs compared to our 3-digit colors. Please get in touch with the Customer Service for a time and quantity estimation of your desired variant.

◆ Core Assortment

2058		Size	SS 5	SS 6	SS 7	SS 8	SS 9	SS 10
	Jonquil Aurore Boreale F (213 AB)		■		■		■	
	Light Rose Aurore Boreale F (223 AB)		■		■		■	
	Light Rose Shimmer F (223 SHIM)		■				■	
	Light Sapphire Shimmer F (211 SHIM)		■				■	
	Light Siam Aurore Boreale F (227 AB)		■		■		■	
	Light Siam Shimmer F (227 SHIM)		■				■	
	Peridot Shimmer F (214 SHIM)		■				■	
	Sapphire Aurore Boreale F (206 AB)		■		■		■	
	Siam Nightfall F (208 NIFA)		■				■	
	Silk Shimmer F (391 SHIM)		■				■	
	Tanzanite Shimmer F (539 SHIM)		■				■	
	Topaz Shimmer F (203 SHIM)		■				■	
Metallic Effects								
	Jet Hematite F (280 HEM)		■		■		■	

2072 Rose Cut Flat Back

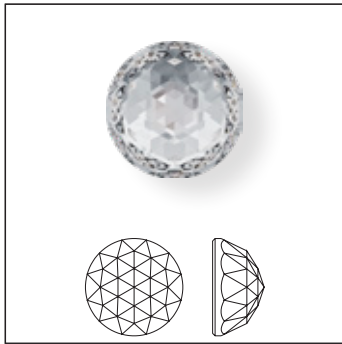

Size
8 mm
10 mm
12 mm

Crystal

Crystal F (001)

CORE ASSORTMENT

2088 XIRIUS Rose

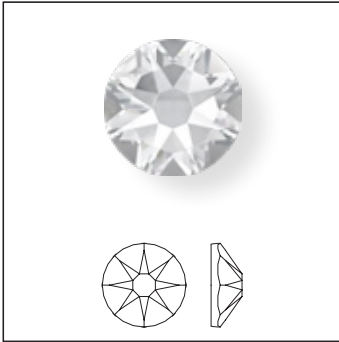

Size	SS 12	SS 14	SS 16	SS 20	SS 24	SS 30	SS 34	SS 40	SS 48
------	-------	-------	-------	-------	-------	-------	-------	-------	-------

Crystal

Crystal F (001)

Colors

Plain Colors

- Amethyst F (204)
- Aquamarine F (202)
- Black Diamond F (215)
- Blue Zircon F (229)
- Blush Rose F (257)
- Capri Blue F (243)
- Denim Blue F (266)
- Emerald F (205)
- Erinite F (360)
- Fuchsia F (502)
- Golden Topaz F (1003)*
- Graphite F (253)
- Greige F (284)
- Indian Siam F (327)
- Iris F (219)
- Jet (280)
- Jet F (280)
- Jonquil F (213)
- Light Amber F (1002)*
- Light Amethyst F (212)
- Light Colorado Topaz F (246)
- Light Peach F (362)
- Light Rose F (223)
- Light Sapphire F (211)
- Light Siam F (227)
- Light Silk F (261)
- Light Topaz F (226)
- Light Turquoise F (263)
- Majestic Blue F (296)
- Montana F (207)
- Padparadscha F (542)
- Peridot F (214)

Crystal F (001)	◆	■	◆	◆	■	◆	◆	■	■
Amethyst F (204)	◆		◆	◆		◆	◆		
Aquamarine F (202)	◆		◆	◆		◆	◆		
Black Diamond F (215)	■		■	■		■	■		
Blue Zircon F (229)	■		■	■		■	■		
Blush Rose F (257)	■		■	■		■	■		
Capri Blue F (243)	■		■	■		■	■		
Denim Blue F (266)	■		■	■		■	■		
Emerald F (205)	◆		◆	◆		◆	◆		
Erinite F (360)	■		■	■		■	■		
Fuchsia F (502)	■		■	■		■	■		
Golden Topaz F (1003)*	■		■	■		■	■		
Graphite F (253)	■		■	■		■	■		
Greige F (284)	■		■	■		■	■		
Indian Siam F (327)	■		■	■		■	■		
Iris F (219)	■		■	■		■	■		
Jet (280)	■		■	■		■	■		
Jet F (280)	◆		◆	◆		◆	◆		
Jonquil F (213)	■		■	■		■	■		
Light Amber F (1002)*	■		■	■		■	■		
Light Amethyst F (212)	■		■	■		■	■		
Light Colorado Topaz F (246)	◆		◆	◆		◆	◆		
Light Peach F (362)	■		■	■		■	■		
Light Rose F (223)	◆		◆	◆		◆	◆		
Light Sapphire F (211)	■		■	■		■	■		
Light Siam F (227)	■		■	■		■	■		
Light Silk F (261)	■		■	■		■	■		
Light Topaz F (226)	■		■	■		■	■		
Light Turquoise F (263)	■		■	■		■	■		
Majestic Blue F (296)	■		■	■		■	■		
Montana F (207)	■		■	■		■	■		
Padparadscha F (542)	■		■	■		■	■		
Peridot F (214)	■		■	■		■	■		































* All colors with a 4-digit color code (i.e. Golden Topaz) are fully customizable with shorter lead times and lower MOQs compared to our 3-digit colors. Please get in touch with the Customer Service for a time and quantity estimation of your desired variant.

◆ Core Assortment

	Size	SS 12	SS 14	SS 16	SS 20	SS 24	SS 30	SS 34	SS 40	SS 48
2088										
Rose F (209)		■		■	■		■	■		
Ruby F (501)		■		■	■		■	■		
Sapphire F (206)		■		■	■		■	■		
Scarlet F (276)		◆		◆	◆		◆	◆		
Siam F (208)		■		■	■		■	■		
Silk F (391)		■		■	■		■	■		
Smoked Amber F (1001)*		■		■	■		■	■		
Tanzanite F (539)		■		■	■		■	■		
Topaz F (203)		■		■	■		■	■		
Vintage Rose F (319)		■		■	■		■	■		
Opal Colors										
White Opal F (234)		■		■	■		■	■		
Crystal Effects										
Transparent Effects										
Crystal Aurore Boreale F (001 AB)		■	■	■	■	■	■	■	■	■
Crystal Blue Shade F (001 BLSH)		■		■	■		■	■		
Crystal Golden Shadow F (001 GSHA)		■		■	■		■	■		
Crystal Moonlight F (001 MOL)		■		■	■		■	■		
Crystal Paradise Shine F (001 PARSH)		■		■	■		■	■		
Crystal Shimmer F (001 SHIM)		■		■	■		■	■		
Crystal Silver Night F (001 SINI)		■		■	■		■	■		
Crystal Silver Shade F (001 SSHA)		■		■	■		■	■		
Crystal Volcano F (001 VOL)		■		■	■		■	■		
Metallic Effects										
Crystal Light Chrome F (001 LTCH)		■		■	■		■	■		
Crystal Metallic Sunshine F (001 METSH)		■		■	■		■	■		
Crystal Rose Gold F (001 ROGL)		■		■	■		■	■		
Crystal Lacquer^{PRO} Effects										
Crystal Shiny Lacquer^{PRO} Effects										
Crystal Electric Blue (001 L134S)		■		■	■		■	■		
Crystal Electric Green (001 L135S)		■		■	■		■	■		
Crystal Electric Orange (001 L136S)		■		■	■		■	■		
Crystal Electric Pink (001 L137S)		■		■	■		■	■		
Crystal Electric Violet (001 L148S)		■		■	■		■	■		
Crystal Electric White (001 L139S)		■		■	■		■	■		
Crystal Electric Yellow (001 L138S)		■		■	■		■	■		

* All colors with a 4-digit color code (i.e. Golden Topaz) are fully customizable with shorter lead times and lower MOQs compared to our 3-digit colors. Please get in touch with the Customer Service for a time and quantity estimation of your desired variant.

◆ Core Assortment

2088		Size	SS 12	SS 14	SS 16	SS 20	SS 24	SS 30	SS 34	SS 40	SS 48
Crystal Lacquer^{PRO} DeLite Effects											
 Crystal Dusty Pink DeLite (001 L149D)			■		■	■		■			
 Crystal Ivory Cream DeLite (001 L106D)			■		■	■		■			
 Crystal Laguna DeLite (001 L142D)			■		■	■		■			
 Crystal Lavender DeLite (001 L144D)			■		■	■		■			
 Crystal Lotus Pink DeLite (001 L145D)			■		■	■		■			
 Crystal Ocean DeLite (001 L143D)			■		■	■		■			
 Crystal Orange Glow DeLite (001 L146D)			■		■	■		■			
 Crystal Royal Blue DeLite (001 L110D)			■		■	■		■			
 Crystal Royal Red DeLite (001 L107D)			■		■	■		■			
 Crystal Serene Gray DeLite (001 L150D)			■		■	■		■			
 Crystal Silky Sage DeLite (001 L147D)			■		■	■		■			
Color Effects											
Transparent Effects											
 Black Diamond Shimmer F (215 SHIM)			■		■	■		■			
 Blue Zircon Shimmer F (229 SHIM)			■		■	■		■			
 Capri Blue Nightfall F (243 NIFA)			■		■	■		■			
 Emerald Nightfall F (205 NIFA)			■		■	■		■			
 Fuchsia Shimmer F (502 SHIM)			■		■	■		■			
 Graphite Nightfall F (253 NIFA)			■		■	■		■			
 Jonquil Aurore Boreale F (213 AB)			■		■	■		■			
 Light Rose Aurore Boreale F (223 AB)			■		■	■		■			
 Light Rose Shimmer F (223 SHIM)			■		■	■		■			
 Light Sapphire Shimmer F (211 SHIM)			■		■	■		■			
 Light Siam Aurore Boreale F (227 AB)			■		■	■		■			
 Light Siam Shimmer F (227 SHIM)			■		■	■		■			
 Peridot Shimmer F (214 SHIM)			■		■	■		■			
 Sapphire Aurore Boreale F (206 AB)			■		■	■		■			
 Siam Nightfall F (208 NIFA)			■		■	■		■			
 Silk Shimmer F (391 SHIM)			■		■	■		■			
 Tanzanite Shimmer F (539 SHIM)			■		■	■		■			
 Topaz Shimmer F (203 SHIM)			■		■	■		■			
Metallic Effects											
 Jet Hematite (280 HEM)			■		■	■		■	■		
 Jet Hematite F (280 HEM)			■		■	■		■	■		

2196/4 Oval Cabochon

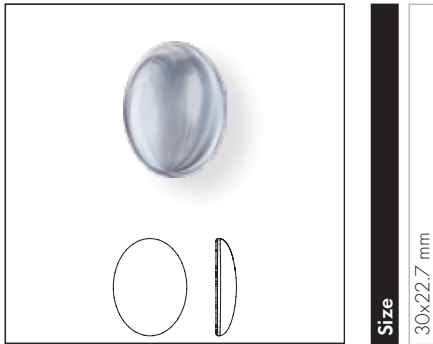

Size

30x22.7 mm

Crystal Effects

Transparent Effects

-  Crystal Golden Shadow V F (001 GSHAV)
-  Crystal Powder Grey AB (001 L105A)
-  Crystal Satin Moroda F (001 SATMO)
-  Crystal Satin Tabak F (001 SATTa)

Crystal Lacquer^{PRO} Effects

Crystal Shiny Lacquer^{PRO} Effects

-  Crystal Mint Green (001 L115S)
-  Crystal Peony Pink (001 L113S)

Crystal Lacquer^{PRO} DeLite Effects

-  Crystal Ocean DeLite (001 L143D)

2200 Navette Flat Back

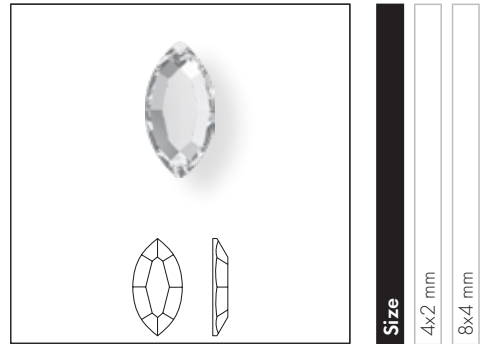

Size

4x2 mm



8x4 mm

Crystal

-  Crystal F (001)

Crystal Effects

Transparent Effects

-  Crystal Aurore Boreale F (001 AB)
-  Crystal Golden Shadow F (001 GSHA)

2201 Marquise Flat Back

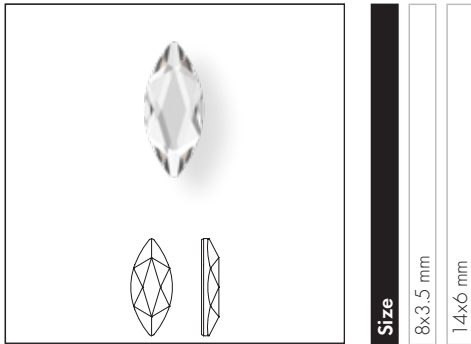

Size
8x3.5 mm
14x6 mm

Crystal

Crystal F (001)

Colors

Plain Colors

Aquamarine F (202)

Emerald F (205)

Graphite F (253)

Jet (280)

Sapphire F (206)

Scarlet F (276)

Vintage Rose F (319)

Crystal Effects

Transparent Effects

Crystal Aurore Boreale F (001 AB)

Crystal Golden Shadow F (001 GSHA)

Color Effects

Transparent Effects

Aquamarine Shimmer F (202 SHIM)

Cobalt Shimmer F (369 SHIM)

Fuchsia Shimmer F (502 SHIM)

Light Sapphire Shimmer F (211 SHIM)

Light Siam Shimmer F (227 SHIM)

Light Topaz Shimmer F (226 SHIM)

Scarlet Shimmer F (276 SHIM)

Silk Shimmer F (391 SHIM)

Vintage Rose Shimmer F (319 SHIM)

2205 Flame Flat Back

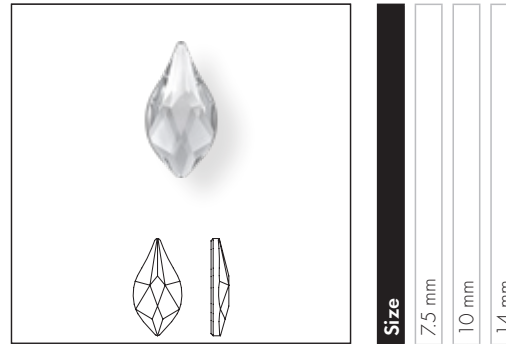

Size
7.5 mm
10 mm
14 mm

Crystal

Crystal F (001)

Colors

Plain Colors

Light Siam F (227)

Opal Colors

White Opal F (234)

Crystal Effects

Transparent Effects

Crystal Aurore Boreale F (001 AB)

Crystal Golden Shadow F (001 GSHA)

Crystal Silver Night F (001 SINI)

2300 Drop Flat Back

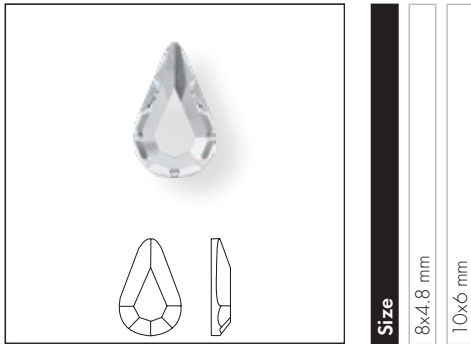

Size

8x4.8 mm

10x6 mm

Crystal

Crystal F (001)

2303 Pear Flat Back

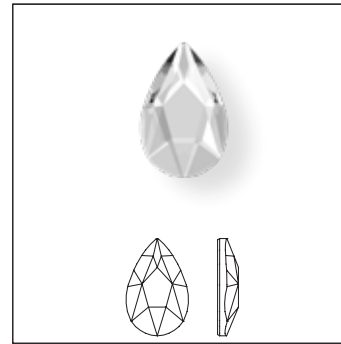

Size

8x5 mm

14x9 mm

Crystal

Crystal F (001)

Colors

Plain Colors

Aquamarine F (202)

Emerald F (205)

Graphite F (253)

Jet (280)

Sapphire F (206)

Scarlet F (276)

Vintage Rose F (319)

Crystal Effects

Transparent Effects

Crystal Aurore Boreale F (001 AB)

Crystal Golden Shadow F (001 GSHA)

Color Effects

Transparent Effects

Aquamarine Shimmer F (202 SHIM)

Cobalt Shimmer F (369 SHIM)

Fuchsia Shimmer F (502 SHIM)

Light Sapphire Shimmer F (211 SHIM)

Light Siam Shimmer F (227 SHIM)

Light Topaz Shimmer F (226 SHIM)

Scarlet Shimmer F (276 SHIM)

Silk Shimmer F (391 SHIM)

Vintage Rose Shimmer F (319 SHIM)

2304 Raindrop Flat Back

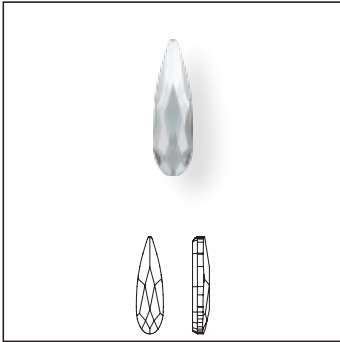

Size	6x1.7 mm	10x2.8 mm	14x3.9 mm
------	----------	-----------	-----------

Crystal

Crystal F (001)

Colors

Plain Colors

Blush Rose F (257)

Light Siam F (227)

Crystal Effects

Transparent Effects

Crystal Aurore Boreale F (001 AB)

Crystal Golden Shadow F (001 GSHA)

Crystal Silver Night F (001 SINI)

PAISLEY FLAT BACKS

2364 Paisley X Flat Back

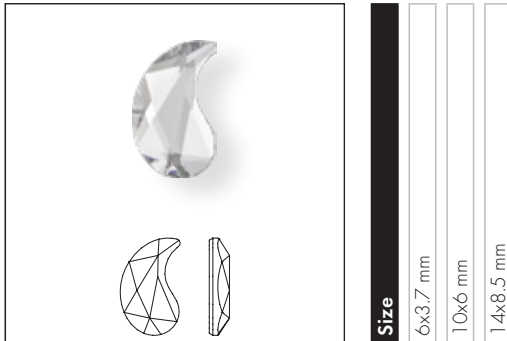

Size

6x3.7 mm
10x6 mm
14x8.5 mm

Crystal

Crystal F (001)

Colors

Plain Colors

Jet (280)

Light Colorado Topaz F (246)

Majestic Blue F (296)

Scarlet F (276)

Crystal Effects

Transparent Effects

Crystal Aurore Boreale F (001 AB)

Crystal Golden Shadow F (001 GSHA)

Crystal Silver Night F (001 SINI)

Crystal Silver Shade F (001 SSHA)

2365 Paisley Y Flat Back



Size

6x3.7 mm
10x6 mm
14x8.5 mm

Crystal

Crystal F (001)

Colors

Plain Colors

Jet (280)

Light Colorado Topaz F (246)

Majestic Blue F (296)

Scarlet F (276)

Crystal Effects

Transparent Effects

Crystal Aurore Boreale F (001 AB)

Crystal Golden Shadow F (001 GSHA)

Crystal Silver Night F (001 SINI)

Crystal Silver Shade F (001 SSHA)

CORE ASSORTMENT

2400 Square Flat Back

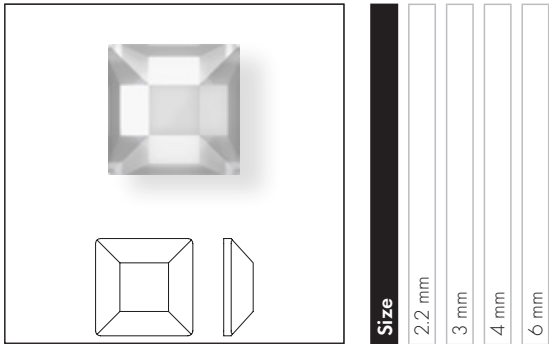

Crystal	2.2 mm	3 mm	4 mm	6 mm
Crystal F (001)	■	◆	◆	◆
Colors				
Plain Colors				
Amethyst F (204)		◆	◆	◆
Aquamarine F (202)		◆	◆	◆
Emerald F (205)		◆	◆	◆
Jet (280)		◆	◆	◆
Light Colorado Topaz F (246)		◆	◆	◆
Light Rose F (223)		◆	◆	◆
Scarlet F (276)		◆	◆	◆
Crystal Effects				
Transparent Effects				
Crystal Aurore Boreale F (001 AB)	■	■	■	■
Crystal Golden Shadow F (001 GSHA)	■	■	■	■
Crystal Silver Night F (001 SINI)		■	■	■
Metallic Effects				
Crystal Light Chrome F (001 LTCH)		■	■	■
Color Effects				
Metallic Effects				
Jet Hematite (280 HEM)			■	■

2471 Cushion Flat Back

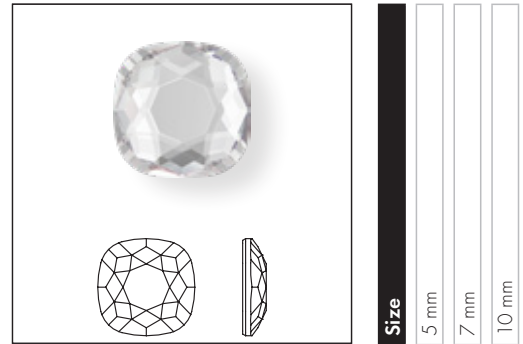

Crystal	5 mm	7 mm	10 mm
Crystal F (001)	■	■	■
Colors			
Plain Colors			
Aquamarine F (202)	■	■	■
Emerald F (205)	■	■	■
Graphite F (253)	■	■	■
Jet (280)	■	■	■
Sapphire F (206)	■	■	■
Scarlet F (276)	■	■	■
Vintage Rose F (319)	■	■	■
Crystal Effects			
Transparent Effects			
Crystal Aurore Boreale F (001 AB)	■	■	■
Crystal Golden Shadow F (001 GSHA)	■	■	■
Color Effects			
Transparent Effects			
Aquamarine Shimmer F (202 SHIM)	■	■	■
Cobalt Shimmer F (369 SHIM)			■
Fuchsia Shimmer F (502 SHIM)			■
Light Sapphire Shimmer F (211 SHIM)			■
Light Siam Shimmer F (227 SHIM)			■
Light Topaz Shimmer F (226 SHIM)			■
Scarlet Shimmer F (276 SHIM)	■	■	■
Silk Shimmer F (391 SHIM)			■
Vintage Rose Shimmer F (319 SHIM)	■	■	■

2472 Trilliant Flat Back

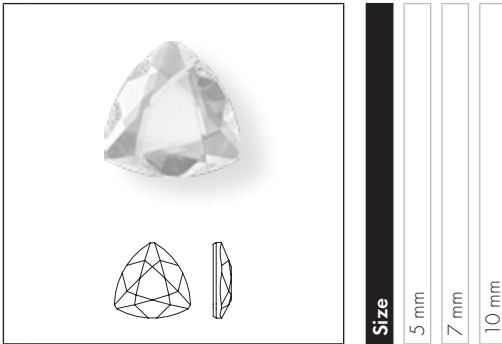

Size
5 mm
7 mm
10 mm

Crystal

Crystal F (001)

Colors

Plain Colors

Aquamarine F (202)

Emerald F (205)

Graphite F (253)

Jet (280)

Scarlet F (276)

Sapphire F (206)

Vintage Rose F (319)

Crystal Effects

Transparent Effects

Crystal AB F (001 AB)

Crystal Golden Shadow F (001 GSHA)

2483 Classic Square Flat Back

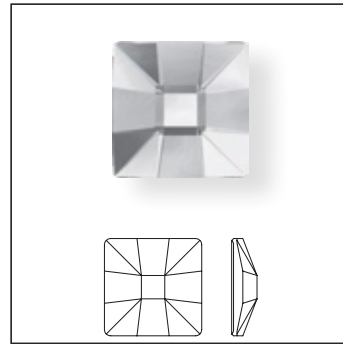

Size
10 mm
25 mm

Crystal

Crystal F (001)

Crystal Effects

Metallic Effects

Crystal Comet Argent Light SI (001 CASI)

Crystal Comet Argent Light V SI (001 CAVSI)

2493 Chessboard Flat Back

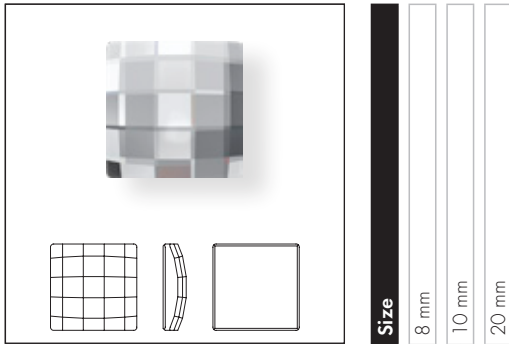

Size
8 mm
10 mm
20 mm

Crystal

Crystal F (001)

Crystal Effects

Transparent Effects

Crystal Aurore Boreale F (001 AB)

2510 Baguette Flat Back

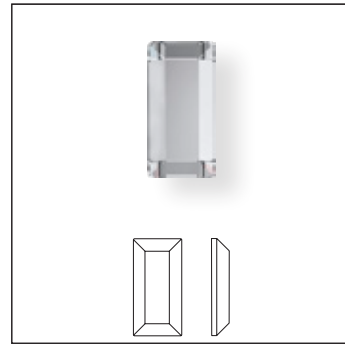

Size
3,7x1,9 mm

Crystal

Crystal F (001)

Colors

Plain Colors

Jet (280)

Crystal Effects

Transparent Effects

Crystal Aurore Boreale F (001 AB)

Crystal Golden Shadow F (001 GSHA)

2520 Cosmic Flat Back

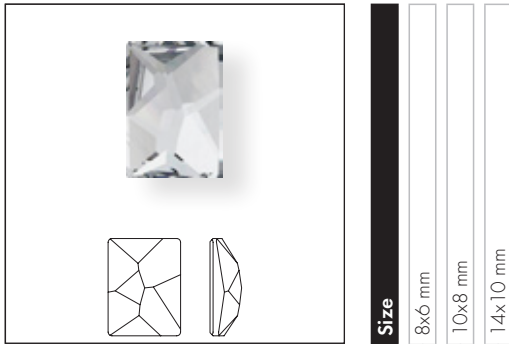

Crystal

Crystal F (001)

Colors

Plain Colors

Jet (280)

Crystal Effects

Transparent Effects

Crystal Aurore Boreale F (001 AB)

Crystal Golden Shadow F (001 GSHA)

2555 Cosmic Baguette Flat Back

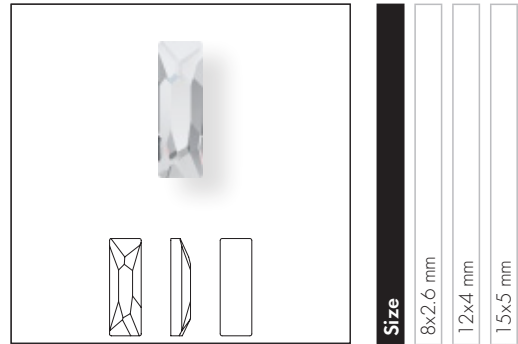

Crystal

Crystal F (001)

Crystal Effects

Transparent Effects

Crystal Golden Shadow F (001 GSHA)

2585 Graphic Flat Back



Size
8 mm
10 mm

- Crystal**
- Crystal F (001)
- Crystal Effects**
- Transparent Effects**
- Crystal Aurore Boreale F (001 AB)

2602 Emerald Cut Flat Back

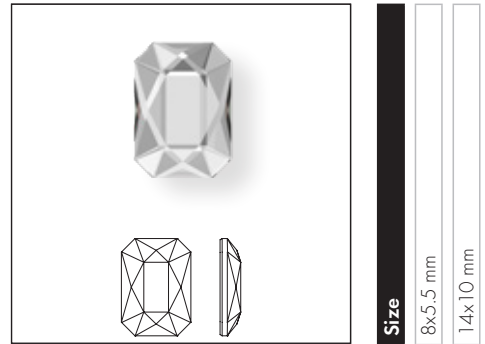

Size
8x5.5 mm
14x10 mm

- Crystal**
- Crystal F (001)
- Colors**
- Plain Colors**
- Aquamarine F (202)
- Emerald F (205)
- Graphite F (253)
- Jet (280)
- Sapphire F (206)
- Scarlet F (276)
- Vintage Rose F (319)
- Crystal Effects**
- Transparent Effects**
- Crystal Aurore Boreale F (001 AB)
- Crystal Golden Shadow F (001 GSHA)
- Color Effects**
- Transparent Effects**
- Aquamarine Shimmer F (202 SHIM)
- Cobalt Shimmer F (369 SHIM)
- Fuchsia Shimmer F (502 SHIM)
- Light Sapphire Shimmer F (211 SHIM)
- Light Siam Shimmer F (227 SHIM)
- Light Topaz Shimmer F (226 SHIM)
- Scarlet Shimmer F (276 SHIM)
- Silk Shimmer F (391 SHIM)
- Vintage Rose Shimmer F (319 SHIM)

2603 Oval Flat Back

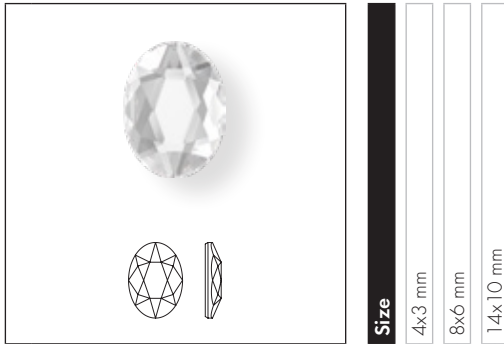

Size
4x3 mm
8x6 mm
14x10 mm

Crystal

Crystal F (001)

Colors

Plain Colors

Aquamarine F (202)

Emerald F (205)

Graphite F (253)

Jet (280)

Scarlet F (276)

Sapphire F (206)

Vintage Rose F (319)

Crystal Effects

Transparent Effects

Crystal AB F (001 AB)

Crystal Golden Shadow F (001 GSHA)

2709 Rhombus Flat Back

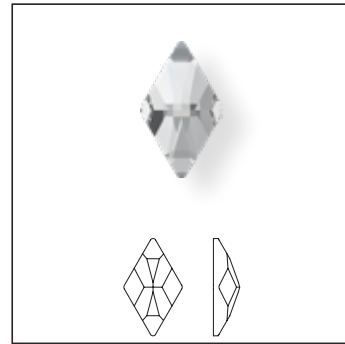

Size
10x6 mm
13x8 mm

Crystal

Crystal F (001)

Colors

Plain Colors

Aquamarine F (202)

Black Diamond F (215)

Light Rose F (223)

Light Siam F (227)

Crystal Effects

Transparent Effects

Crystal Aurore Boreale F (001 AB)

Crystal Golden Shadow F (001 GSHA)

Crystal Silver Shade F (001 SSHA)

2711 Triangle Flat Back

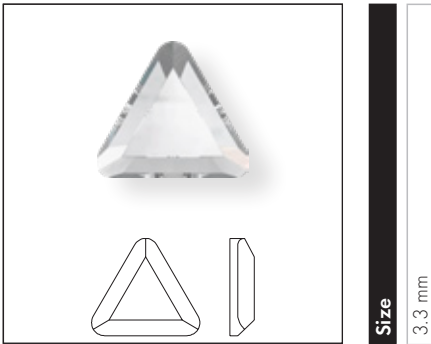

Size
3.3 mm

- Crystal**
- Crystal F (001)
- Crystal Effects**
- Transparent Effects**
- Crystal Aurore Boreale F (001 AB)
- Crystal Golden Shadow F (001 GSHA)

2715 Connector Flat Back

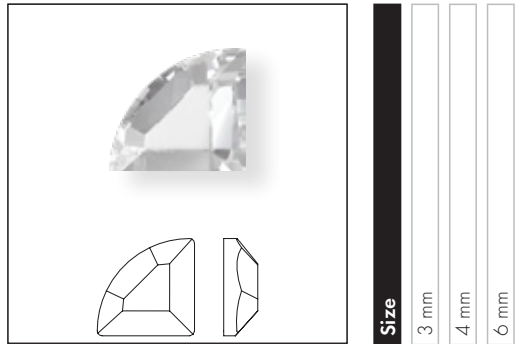

Size
3 mm
4 mm
6 mm

- Crystal**
- Crystal F (001)
- Colors**
- Plain Colors**
- Amethyst F (204)
- Aquamarine F (202)
- Emerald F (205)
- Jet (280)
- Light Colorado Topaz F (246)
- Scarlet F (276)
- Crystal Effects**
- Transparent Effects**
- Crystal Aurore Boreale F (001 AB)
- Crystal Golden Shadow F (001 GSHA)
- Crystal Silver Night F (001 SINI)
- Metallic Effects**
- Crystal Light Chrome F (001 LTCH)
- Color Effects**
- Metallic Effects**
- Jet Hematite (280 HEM)

2716 Rivoli Triangle Flat Back

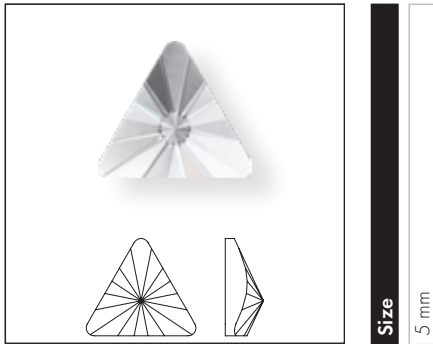

Size
5 mm

Crystal

Crystal F (001)

Crystal Effects

Transparent Effects

Crystal Aurore Boreale F (001 AB)

TRIANGLE FAMILY

2738 Triangle Alpha Flat Back

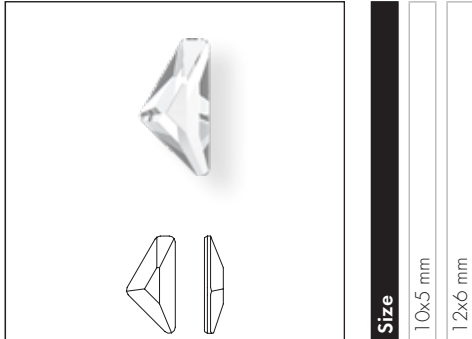

Size

10x5 mm

12x6 mm

Crystal

Crystal F (001)

Crystal Effects

Transparent Effects

Crystal Aurore Boreale F (001 AB)

Crystal Golden Shadow F (001 GSHA)

Crystal Silver Night F (001 SINI)

2739 Triangle Beta Flat Back



Size

5.8x5.3 mm

7x6.5 mm

Crystal

Crystal F (001)

Crystal Effects

Transparent Effects

Crystal Aurore Boreale F (001 AB)

Crystal Golden Shadow F (001 GSHA)

Crystal Silver Night F (001 SINI)

2740 Triangle Gamma Flat Back

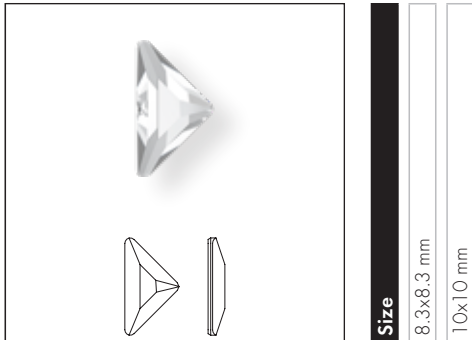

Size

8.3x8.3 mm

10x10 mm

Crystal

Crystal F (001)

Crystal Effects

Transparent Effects

Crystal Aurore Boreale F (001 AB)

Crystal Golden Shadow F (001 GSHA)

Crystal Silver Night F (001 SINI)

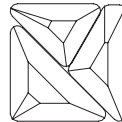

When Alpha, Beta, and Gamma Flat Backs are arranged together, they form a square.

2770 Wing Flat Back

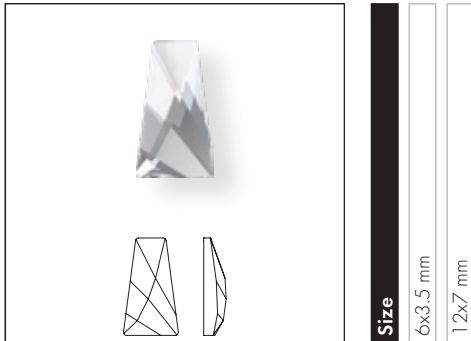

Crystal

Crystal F (001)

Colors

Plain Colors

Black Diamond F (215)

Crystal Effects

Transparent Effects

Crystal Golden Shadow F (001 GSHA)

GEOMETRIC FLAT BACKS

2771 Kite Flat Back

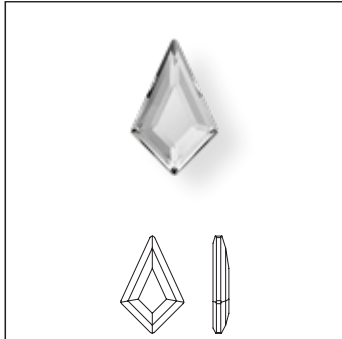

Size
6.4x4.2 mm
8.6x5.6 mm
12.9x8.3 mm

Crystal
Crystal F (001)
Colors
Plain Colors
Aquamarine F (202)
Black Diamond F (215)
Jet (280)
Light Rose F (223)
Light Siam F (227)
Crystal Effects
Transparent Effects
Crystal Aurore Boreale F (001 AB)
Crystal Golden Shadow F (001 GSXA)
Crystal Silver Shade F (001 SSXA)
Color Effects
Metallic Effects
Jet Hematite (280 HEM)

2772 Trapeze Flat Back

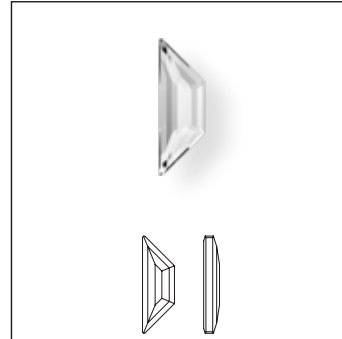

Size
6.5x2.1 mm
8.6x2.8 mm
12.9x4.2 mm

Crystal
Crystal F (001)
Colors
Plain Colors
Aquamarine F (202)
Black Diamond F (215)
Jet (280)
Crystal Effects
Transparent Effects
Crystal Aurore Boreale F (001 AB)
Crystal Golden Shadow F (001 GSXA)
Crystal Silver Shade F (001 SSXA)
Color Effects
Metallic Effects
Jet Hematite (280 HEM)

2773 Diamond Shape Flat Back

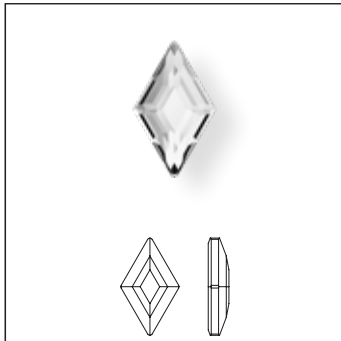

Size
5x3 mm
6.6x3.9 mm
9.9x5.9 mm

Crystal
Crystal F (001)
Colors
Plain Colors
Aquamarine F (202)
Black Diamond F (215)
Jet (280)
Light Rose F (223)
Light Siam F (227)
Crystal Effects
Transparent Effects
Crystal Aurore Boreale F (001 AB)
Crystal Golden Shadow F (001 GSHA)
Crystal Silver Shade F (001 SSHA)
Color Effects
Metallic Effects
Jet Hematite (280 HEM)

2774 Elongated Pentagon Flat Back

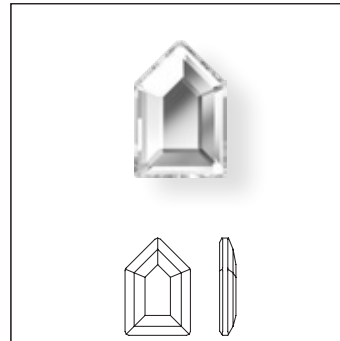

Size
6.3x4.2 mm
8.3x5.6 mm
12.5x8.4 mm

Crystal
Crystal F (001)
Colors
Plain Colors
Aquamarine F (202)
Black Diamond F (215)
Jet (280)
Light Siam F (227)
Crystal Effects
Transparent Effects
Crystal Aurore Boreale F (001 AB)
Crystal Silver Shade F (001 SSHA)
Color Effects
Metallic Effects
Jet Hematite (280 HEM)

2775 Concise Pentagon Flat Back

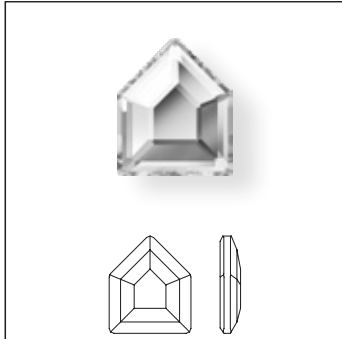

Size
5x4.2 mm
6.7x5.6 mm
10x8.4 mm

Crystal
Crystal F (001)
Colors
Plain Colors
Aquamarine F (202)
Black Diamond F (215)
Jet (280)
Light Siam F (227)
Crystal Effects
Transparent Effects
Crystal Aurore Boreale F (001 AB)
Crystal Silver Shade F (001 SSHA)
Color Effects
Metallic Effects
Jet Hematite (280 HEM)

2776 Elongated Hexagon Flat Back

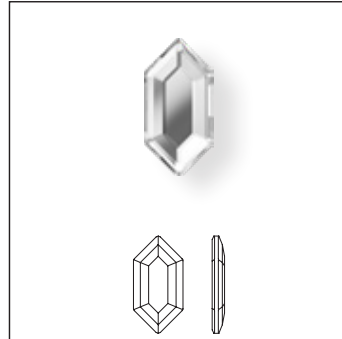

Size
8.2x4.2 mm
11x5.6 mm
16.5x8.4 mm

Crystal
Crystal F (001)
Colors
Plain Colors
Aquamarine F (202)
Black Diamond F (215)
Jet (280)
Light Siam F (227)
Crystal Effects
Transparent Effects
Crystal Aurore Boreale F (001 AB)
Crystal Silver Shade F (001 SSHA)
Color Effects
Metallic Effects
Jet Hematite (280 HEM)

2777 Concise Hexagon Flat Back

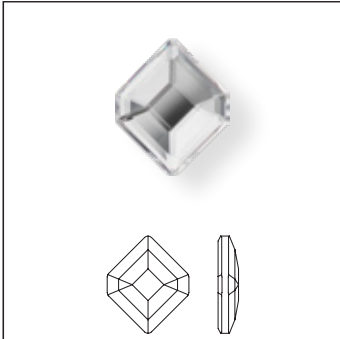

Size
5x4.2 mm
6.7x5.6 mm
10x8.4 mm

Crystal

Crystal F (001)

Colors

Plain Colors

Aquamarine F (202)

Black Diamond F (215)

Jet (280)

Light Siam F (227)

Crystal Effects

Transparent Effects

Crystal Aurore Boreale F (001 AB)

Crystal Silver Shade F (001 SSHA)

Color Effects

Metallic Effects

Jet Hematite (280 HEM)

Crystal F (001)	■	■	■
Aquamarine F (202)	■	■	
Black Diamond F (215)	■	■	■
Jet (280)	■	■	
Light Siam F (227)	■	■	■
Crystal Aurore Boreale F (001 AB)	■	■	■
Crystal Silver Shade F (001 SSHA)	■	■	
Jet Hematite (280 HEM)	■	■	■

2808 Heart Flat Back

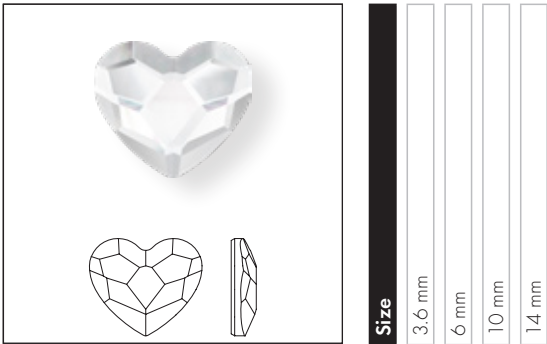

Crystal	
Crystal F (001)	■ ■ ■ ■
Colors	
Plain Colors	
Denim Blue F (266)	■ ■ ■ ■
Fuchsia F (502)	■ ■ ■ ■
Light Siam F (227)	■ ■ ■ ■
Light Silk F (261)	■ ■ ■ ■
Crystal Effects	
Transparent Effects	
Crystal Antique Pink F (001 ANTP)	■ ■ ■ ■
Crystal Aurore Boreale F (001 AB)	■ ■ ■ ■
Crystal Golden Shadow F (001 GSHA)	■ ■ ■ ■

2813 Moon Flat Back

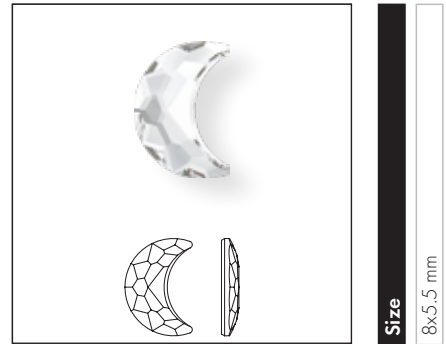

Crystal	
Crystal F (001)	■
Colors	
Plain Colors	
Jet (280)	■
Crystal Effects	
Transparent Effects	
Crystal Aurore Boreale F (001 AB)	■

2816 Rivoli Star Flat Back

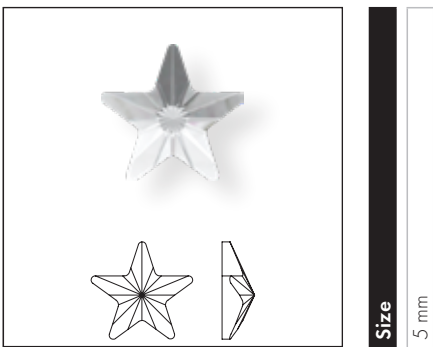

Crystal	
Crystal F (001)	■
Crystal Effects	
Transparent Effects	
Crystal Aurore Boreale F (001 AB)	■

2854 Butterfly Flat Back

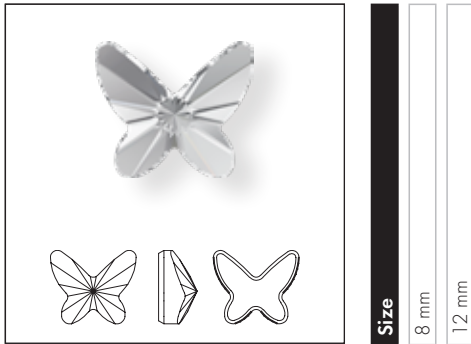

Size
8 mm
12 mm

- Crystal**
- Crystal F (001)
- Colors**
- Plain Colors**
- Amethyst F (204)
- Denim Blue F (266)
- Light Rose F (223)
- Crystal Effects**
- Transparent Effects**
- Crystal Aurore Boreale F (001 AB)
- Crystal Silver Night F (001 SINI)

2856 Skull Flat Back

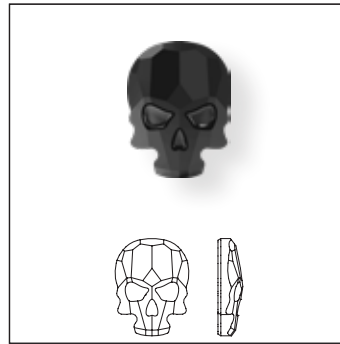

Size
10x7.5 mm
14x10.5 mm
18x14 mm

- Colors**
- Plain Colors**
- Jet (280)
- Crystal Effects**
- Transparent Effects**
- Crystal Aurore Boreale F (001 AB)
- Crystal Golden Shadow F (001 GSHA)
- Crystal Silver Night F (001 SINI)
- Metallic Effects**
- Crystal Light Chrome F (001 LTCH)
- Color Effects**
- Metallic Effects**
- Jet Hematite (280 HEM)

Product Details

Article Size	Packing Unit = Minimum Order Quantity in Pieces	Average Net Weight in Gram per Packing Unit Crystal (001)	Average Gross Weight in Gram per Packing Unit Crystal (001)
2000			
SS 3	1,440	1.8	12.7
SS 4	1,440	3.3	13.7
2019			
4 mm	144	10.8	32.1
5 mm	72	10.2	29.5
6 mm	72	17.4	35.0
2035			
6 mm	360	27.1	34.8
10 mm	192	56.2	88.0
14 mm	96	88.4	109.0
20 mm	40	82.0	121.4
30 mm	12	95.4	130.8
40 mm	6	105.3	140.3
2058			
SS 5	1,440	4.4	17.9
SS 6	1,440	5.7	17.6
SS 7	1,440	7.1	19.0
SS 8	1,440	10.1	19.6
SS 9	1,440	12.4	22.0
SS 10	1,440	15.8	25.3
2072			
8 mm	288	92.9	119.6
10 mm	144	90.6	111.0
12 mm	72	82.0	100.1
2088			
SS 12	1,440	22.1	30.3
SS 14	1,440	30.1	38.3
SS 16	1,440	39.9	49.8
SS 20	1,440	72.2	80.9
SS 24	1,440	127.12	136.3
SS 30	288	34.6	63.0
SS 34	144	25.9	48.6
SS 40	144	50.0	75.1
SS 48	96	76.1	101.3
2196/4			
30x22.7 mm	8	44.8	64.4
2200			
4x2 mm	720	6.5	18.5
8x4 mm	720	49.6	60.2
2201			
8x3.5 mm	144	10.03	31.11
14x6 mm	72	21.67	45.27
2205			
7.5 mm	288	20.3	30.5
10 mm	144	17.6	42.4
14 mm	72	22.3	45.9

Article Size	Packing Unit = Minimum Order Quantity in Pieces	Average Net Weight in Gram per Packing Unit Crystal (001)	Average Gross Weight in Gram per Packing Unit Crystal (001)
2300			
8x4.8 mm	720	83.9	94.5
10x6 mm	360	56.9	67.8
2303			
8x5 mm	144	15.70	39.60
14x9 mm	72	36.65	60.25
2304			
10x2.8 mm	180	10.3	20.5
14x3.9 mm	96	13.1	36.3
6x1.7 mm	360	7.5	16.2
2364			
6x3.7 mm	288	13.9	37.1
10x6 mm	72	14.8	37.9
14x8.5 mm	72	34.9	59.7
2365			
6x3.7 mm	288	13.9	37.0
10x7 mm	72	14.8	37.9
14x8.5 mm	72	34.9	59.7
2400			
2.2 mm	1,440	11.3	21.7
3 mm	1,440	25.3	36.8
4 mm	720	30.0	41.0
6 mm	144	21.6	32.5
2471			
5 mm	288	17.3	25.6
7 mm	72	11.9	35.1
10 mm	72	30.2	51.6
2472			
5 mm	288	17.4	27.6
7 mm	144	20.8	42.8
10 mm	96	34.5	56.5
2483			
10 mm	144	90.3	120.2
25 mm	32	233.3	261.5
2493			
8 mm	216	72.3	91.8
10 mm	144	84.4	106.1
20 mm	24	108.5	137.9
2510			
3.7x1.9 mm	720	8.2	10.6
2520			
8x6 mm	288	50.8	80.2
10x8 mm	144	72.3	90.4
14x10 mm	144	119.3	140.8

Article Size	Packing Unit = Minimum Order Quantity in Pieces	Average Net Weight in Gram per Packing Unit Crystal (001)	Average Gross Weight in Gram per Packing Unit Crystal (001)
2555			
8x2.6 mm	240	18.4	27.5
12x4 mm	144	28.8	33.6
15x5 mm	72	28.9	46.0
2585			
8 mm	288	48.2	68.1
10 mm	288	72.3	104.3
2602			
8x5.5 mm	144	17.89	41.79
14x10 mm	72	58.61	82.21
2603			
4x3 mm	288	6.8	17.0
8x6 mm	144	21.7	43.7
14x10 mm	72	50.3	72.3
2709			
10x6 mm	288	48.2	73.6
13x8 mm	144	41.0	60.1
2711			
3.3 mm	720	10.2	16.4
2715			
3 mm	288	4.0	14.2
4 mm	288	8.2	18.4
6 mm	144	18.4	28.6
2716			
5 mm	720	35.8	75.1
2304			
6x1.7 mm	360	7.5	16.2
2738			
10x5 mm	144	16.7	35.1
12x6 mm	96	20.2	38.3
2739			
5.8x5.3 mm	216	19.2	41.9
7x6.5 mm	144	22.6	39.8
2740			
8.3x8.3 mm	216	35.1	54.2
10x10 mm	96	25.1	41.1
2770			
6x3.5 mm	1,440	60.3	70.3
12x7 mm	192	49.8	98.4
2771			
6.4x4.2 mm	288	9.04	17.87
8.6x5.6 mm	216	16.84	43.02
12.9x8.3 mm	144	36.29	61.39

Article Size	Packing Unit = Minimum Order Quantity in Pieces	Average Net Weight in Gram per Packing Unit Crystal (001)	Average Gross Weight in Gram per Packing Unit Crystal (001)
2772			
6.5x2.1 mm	288	6.39	15.17
8.6x2.8 mm	288	16.29	40.71
12.9x4.2 mm	144	25.57	53.86
2773			
5x3 mm	288	4.83	13.66
6.6x3.9 mm	288	11.23	35.65
9.9x5.9 mm	144	19.30	43.39
2774			
6.3x4.2 mm	288	18.7	29.6
8.3x5.6 mm	144	19.5	39.4
12.5x8.4 mm	96	39.0	60.3
2775			
5x4.2 mm	288	13.9	24.7
6.7x5.6 mm	144	15.0	34.3
10x8.4 mm	144	43.6	66.4
2776			
8.2x4.2 mm	144	11.2	30.1
11x5.6 mm	72	11.3	28.8
16.5x8.4 mm	72	35.6	55.8
2777			
5x4.2 mm	288	10.4	21.3
6.7x5.6 mm	144	10.5	29.7
10x8.4 mm	144	32.8	52.7
2808			
3.6 mm	720	18.4	20.8
6 mm	288	19.8	28.9
10 mm	144	38.8	55.9
14 mm	96	56.4	86.8
2813			
8x5.5 mm	144	13.1	37.7
2816			
5 mm	720	23.6	30.7
2854			
8 mm	216	36.0	52.2
12 mm	144	84.4	103.8
2856			
10x7.5 mm	72	20.2	38.6
14x10.5 mm	36	30.2	50.3
18x14 mm	30	53.0	83.4