

# Pendants

Pendants have timeless elegance and are available in a large range of classical and avant-garde cuts and shapes, as well as many colors and effects. Pendants offer a whole range of design possibilities for different segments thanks to their easy application, with the top hole requiring only a jump ring/pinch bail with a chain or cord. Due to the diverse range of sizes available, Pendants are ideal for creating jewelry sets such as necklaces, bracelets, and earrings as well as apparel and accessories.



# Colors & Effects











## Colors

 Crystal 001	 Sapphire 206
 Light Rose 223	 Capri Blue 243
 Rose 209	 <u>Majestic Blue!</u> 296
 Padparadscha 542	 Montana 207
 Light Siam 227	 Light Turquoise 263
 <u>Scarlet</u> 276	 Blue Zircon 229
 Ruby 501	 <u>Denim Blue</u> 266
 Siam 208	 Peridot 214
 Fuchsia 502	 Emerald 205
 Amethyst 204	 Light Colorado Topaz 246
 <u>Iris</u> 219	 Light Topaz 226
 Light Amethyst 212	 <u>Golden Topaz</u> 1003
 Violet 371	 Topaz 203
 Tanzanite 539	 <u>Smoked Amber</u> 1001
 Light Sapphire 211	 Jet 280
 Aquamarine 202	









## Effects

 <u>Crystal Silver Shade</u> 001 SSHA
 Crystal Moonlight 001 MOL
 Crystal Aurore Boreale 001 AB
 Crystal Shimmer 001 SHIM
 Crystal Golden Shadow 001 GSHA
 Crystal Metallic Sunshine* 001 METSH
 Crystal Antique Pink* 001 ANTP
 Crystal Vitrail Light** 001 VL
 <u>Crystal Paradise Shine*</u> 001 PARSH
 Crystal Vitrail Medium** 001 VM
 Crystal Heliotrope** 001 HEL
 Crystal Bermuda Blue** 001 BBL
 Crystal Blue Shade* 001 BLSH
 Crystal Silver Night** 001 SINI

## AB Effects

 Light Rose Aurore Boreale 223 AB
 Light Siam Aurore Boreale 227 AB
 Rose Aurore Boreale 209 AB
 Fuchsia Aurore Boreale 502 AB
 Siam Aurore Boreale 208 AB
 Violet Aurore Boreale 371 AB
 Aquamarine Aurore Boreale 202 AB
 Sapphire Aurore Boreale 206 AB
 Blue Zircon Aurore Boreale 229 AB
 Peridot Aurore Boreale 214 AB
 Light Topaz Aurore Boreale 226 AB

## Shimmer Effects

 Light Rose Shimmer 223 SHIM
 Light Siam Shimmer 227 SHIM
 Light Amethyst Shimmer 212 SHIM
 Amethyst Shimmer 204 SHIM
 Light Sapphire Shimmer 211 SHIM
 Aquamarine Shimmer 202 SHIM
 Emerald Shimmer 205 SHIM
 Light Colorado Topaz Shimmer 246 SHIM
 Light Topaz Shimmer 226 SHIM

## Numerical Order

001	Crystal	205 SHIM	Emerald Shimmer	227 AB	Light Siam Aurore Boreale
001 AB	Crystal Aurore Boreale	206	Sapphire	227 SHIM	Light Siam Shimmer
001 ANTP	Crystal Antique Pink*	206 AB	Sapphire Aurore Boreale	229	Blue Zircon
001 BBL	Crystal Bermuda Blue**	207	Montana	229 AB	Blue Zircon Aurore Boreale
001 BLSH	Crystal Blue Shade*	208	Siam	243	Capri Blue
001 GSHA	Crystal Golden Shadow	208 AB	Siam Aurore Boreale	246	Light Colorado Topaz
001 HEL	Crystal Heliotrope**	209	Rose	246 SHIM	Light Colorado Topaz Shimmer
001 METSH	Crystal Metallic Sunshine*	209 AB	Rose Aurore Boreale	263	Light Turquoise
001 MOL	Crystal Moonlight	211	Light Sapphire	266	<u>Denim Blue</u>
001 PARSH	<u>Crystal Paradise Shine*</u>	211 SHIM	Light Sapphire Shimmer	276	<u>Scarlet</u>
001 SHIM	Crystal Shimmer	212	Light Amethyst	280	Jet
001 SINI	Crystal Silver Night**	212 SHIM	Light Amethyst Shimmer	296	<u>Majestic Blue</u> <sup>1</sup>
001 SSHA	<u>Crystal Silver Shade</u>	214	Peridot	371	Violet
001 VL	Crystal Vitrail Light**	214 AB	Peridot Aurore Boreale	371 AB	Violet Aurore Boreale
001 VM	Crystal Vitrail Medium**	219	<u>Iris</u>	501	Ruby
202	Aquamarine	223	Light Rose	502	Fuchsia
202 AB	Aquamarine Aurore Boreale	223 AB	Light Rose Aurore Boreale	502 AB	Fuchsia Aurore Boreale
202 SHIM	Aquamarine Shimmer	223 SHIM	Light Rose Shimmer	539	Tanzanite
203	Topaz	226	Light Topaz	542	Padparadscha
204	Amethyst	226 AB	Light Topaz Aurore Boreale	1001	<u>Smoked Amber</u>
204 SHIM	Amethyst Shimmer	226 SHIM	Light Topaz Shimmer	1003	<u>Golden Topaz</u>
205	Emerald	227	Light Siam		

## Alphabetical Order

Amethyst (204)	Crystal Vitrail Medium (001 VM)**	Light Topaz Aurore Boreale (226 AB)
Amethyst Shimmer (204 SHIM)	<u>Denim Blue (266)</u>	Light Topaz Shimmer (226 SHIM)
Aquamarine (202)	Emerald (205)	Light Turquoise (263)
Aquamarine Aurore Boreale (202 AB)	Emerald Shimmer (205 SHIM)	<u>Majestic Blue (296)</u> <sup>1</sup>
Aquamarine Shimmer (202 SHIM)	Fuchsia (502)	Montana (207)
Blue Zircon (229)	Fuchsia Aurore Boreale (502 AB)	Padparadscha (542)
Blue Zircon Aurore Boreale (229 AB)	<u>Golden Topaz (1003)</u>	Peridot (214)
Capri Blue (243)	<u>Iris (219)</u>	Peridot Aurore Boreale (214 AB)
Crystal (001)	Jet (280)	Rose (209)
Crystal Antique Pink (001 ANTP)*	Light Amethyst (212)	Rose Aurore Boreale (209 AB)
Crystal Aurore Boreale (001 AB)	Light Amethyst Shimmer (212 SHIM)	Ruby (501)
Crystal Bermuda Blue (001 BBL)**	Light Colorado Topaz (246)	Sapphire (206)
Crystal Blue Shade (001 BLSH)*	Light Colorado Topaz Shimmer (246 SHIM)	Sapphire Aurore Boreale (206 AB)
Crystal Golden Shadow (001 GSHA)	Light Rose (223)	<u>Scarlet (276)</u>
Crystal Heliotrope (001 HEL)**	Light Rose Aurore Boreale (223 AB)	Siam (208)
Crystal Metallic Sunshine (001 METSH)*	Light Rose Shimmer (223 SHIM)	Siam Aurore Boreale (208 AB)
Crystal Moonlight (001 MOL)	Light Sapphire (211)	<u>Smoked Amber (1001)</u>
<u>Crystal Paradise Shine (001 PARSH)*</u>	Light Sapphire Shimmer (211 SHIM)	Tanzanite (539)
Crystal Shimmer (001 SHIM)	Light Siam (227)	Topaz (203)
Crystal Silver Night (001 SINI)**	Light Siam Aurore Boreale (227 AB)	Violet (371)
<u>Crystal Silver Shade (001 SSHA)</u>	Light Siam Shimmer (227 SHIM)	Violet Aurore Boreale (371 AB)
Crystal Vitrail Light (001 VL)**	Light Topaz (226)	

Please note that the article (6228) displayed here is only meant as a reference and isn't available in all of the colors/effects as standard. For details on available colors and effects for each article within the product groups, please see the product matrix of the respective item in the Collection 2021. For color and effect samples, please refer to Beads Color Chart.

The plating resistance of effects is tested according to Swarovski's plating guidelines (SWAROVSKI.COM/S-PROFESSIONALS). Customers are advised to carry out their own tests if their plating parameters diverge from Swarovski plating guidelines.

\* Crystals are not resistant to plating and similar processing.

\*\* Crystals are resistant to plating only if they are F-foiled.

<sup>1</sup> Majestic Blue's intense ultramarine hue is difficult to recreate accurately in print due to the fact that the CMYK color spectrum is used in the printing process. In order to get a truer impression of its color, please use RGB digital pictures or, ideally, ask for actual samples.

**Classic Colors/Effects:** This color range offers a wide choice of traditional Swarovski crystal colors and effects.

**Exclusive Colors/Effects:** This color range is offered exclusively by Swarovski.

Colors and effects can appear different when illuminated with different light sources. Swarovski uses standard light source D50 for color decision and comparison. Slight changes in shades are unavoidable. Colors may vary according to cut and foiling.

The composition of Advanced Crystal is compliant with regulatory industry norms and laws regarding the restriction or prohibition of certain substances in the most relevant segments of our customers. Please note that the compliance of the crystal colors Light Siam and Siam varies according to certain industry regulations. Those regulations are indicated with \* in the compliance overview. Indian Siam and Scarlet (option to Lt. Siam) conform to all CLEAR-lists. For further information please visit [swarovski.com/s-professionals](http://swarovski.com/s-professionals)

# Summary

1 2 3



**6000**  
11x5.5, 13x6.5, 15x7.5,  
22x11 mm

1 2 3



**6090**  
16x11, 22x15 mm

1 2 3

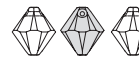

**6328**  
6, 8 mm



**6002**  
10x7, 15x11.5 mm



**6100**  
24x12 mm

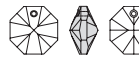

**6401**  
8, 12 mm



**6007**  
7x4, 9x5 mm



**CORE ASSORTMENT**  
**6106**  
16, 22, 28, 38 mm



**CORE ASSORTMENT**  
**6428**  
6, 8, 12 mm

**CORE ASSORTMENT**



**6010**  
11x5.5, 13x6.5,  
17x8.5, 21x10.5 mm



**6128**  
8, 10, 12 mm



**6430**  
8, 10, 14 mm



**6015**  
17, 21 mm



**6210**  
12, 17 mm

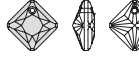

**6431**  
9, 11.5, 16 mm



**6017/G**  
30, 56 mm



**6215**  
18 mm



**6432**  
8, 10.5, 14.5 mm



**6020**  
18, 30, 37 mm



**6225**  
10, 18, 28 mm



**6433**  
9, 11.5, 16 mm

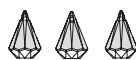

**6022**  
14, 24 mm



**CORE ASSORTMENT**  
**6228**  
10.3x10, 14.4x14,  
18x17.5, 28 mm



**6435**  
9, 11.5, 16 mm



**6028**  
8, 10, 12, 18 mm



**6240**  
12, 17, 27 mm



**6460**  
20 mm



**6040**  
20, 30, 40 mm



**6261**  
17, 27, 36 mm



**6480**  
18, 28, 39 mm



**6049**  
20, 30 mm



**6264**  
18, 28 mm



**6533**  
17.5, 23, 33 mm

1 Front view 2 Side view 3 Back view

"1 Front view" or "3 Back view" shaded in gray: surface effect is applied to this side.

"2 Side view" shaded in gray: side of surface effect not defined (for all symmetrical and some asymmetrical articles).

Where all views are shaded in gray, the effect is applied over the entire marked surface.



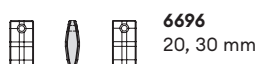
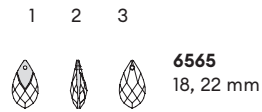

1 Front view 2 Side view 3 Back view

"1 Front view" or "3 Back view" shaded in gray: the surface effect is applied to this side.

"2 Side view" shaded in gray: side of surface effect not defined (for all symmetrical and some asymmetrical articles).

6721: 16, 20 mm: no defined side for surface effect; 28, 40 mm surface effect on "3 Back view."

6864: Reverse effect "V" is the standard version and is therefore shaded.



6000 Classic Drop Pendant

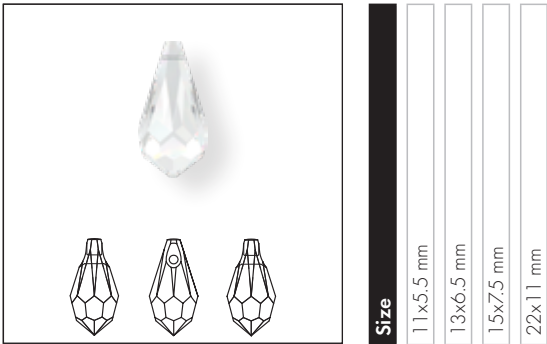

Size

11x5.5 mm  
13x6.5 mm  
15x7.5 mm  
22x11 mm

Crystal

Crystal (001)

Colors

Plain Colors

- Amethyst (204)
- Aquamarine (202)
- Emerald (205)
- Jet (280)
- Light Siam (227)
- Majestic Blue (296)
- Rose (209)
- Sapphire (206)
- Scarlet (276)
- Siam (208)
- Tanzanite (539)
- Topaz (203)

Crystal Effects

Transparent Effects

- Crystal Aurore Boreale (001 AB)
- Crystal Paradise Shine (001 PARSH)

6002 Oval Disco Pendant

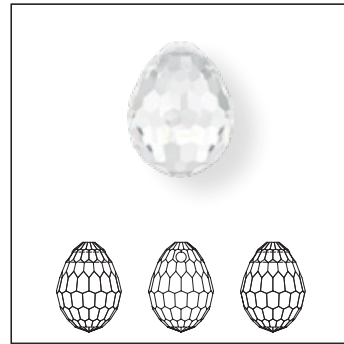

Size

10x7 mm  
15x11.5 mm

Crystal

Crystal (001)

Crystal Effects

Transparent Effects

Crystal Aurore Boreale (001 AB)

05

6007 Small Briolette Pendant



Size

7x4 mm  
9x5 mm

Crystal

Crystal (001)

Crystal Effects

Transparent Effects

- Crystal Aurore Boreale (001 AB)
- Crystal Golden Shadow (001 GSHA)

**CORE ASSORTMENT**

**6010** Briolette Pendant

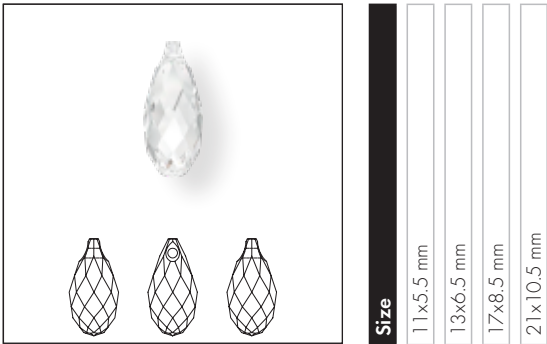

Crystal	11x5.5 mm	13x6.5 mm	17x8.5 mm	21x10.5 mm
Crystal (001)	◆	◆	◆	■
<b>Colors</b>				
<b>Plain Colors</b>				
Amethyst (204)	◆	◆	◆	
Aquamarine (202)	◆	◆	◆	
Denim Blue (266)	■	■		
Emerald (205)	◆	◆	◆	
Erinite (360)	■	■		
Fuchsia (502)	■	■		
Golden Topaz (1003)*	■	■		
Iris (219)	■	■	■	
Jet (280)	◆	◆	◆	
Light Colorado Topaz (246)	◆	◆	◆	
Light Rose (223)	◆	◆	◆	
Light Turquoise (263)	■	■		
Padparadscha (542)	■	■		
Scarlet (276)	◆	◆	◆	
Siam (208)	■	■		
Smoked Amber (1001)*	■	■		
Tanzanite (539)	■	■	■	
<b>Crystal Effects</b>				
<b>Transparent Effects</b>				
Crystal Aurore Boreale (001 AB)	■	■	■	■
Crystal Blue Shade (001 BLSH)	■	■		
Crystal Golden Shadow (001 GSHA)	■	■	■	■
Crystal Paradise Shine (001 PARSH)	■	■		
Crystal Silver Night (001 SINI)	■	■		
Crystal Silver Shade (001 SSHA)	■	■		

**6015** Polygon Drop



Crystal	17 mm	21 mm
Crystal (001)	■	■
<b>Crystal Effects</b>		
<b>Transparent Effects</b>		
Crystal Aurore Boreale (001 AB)	■	■
Crystal Golden Shadow (001 GSHA)	■	■

\* All colors with a 4-digit color code (i.e. Golden Topaz) are fully customizable with shorter lead times and lower MOQs compared to our 3-digit colors. Please get in touch with the Customer Service for a time and quantity estimation of your desired variant.

# Maison Margiela for Swarovski

## CRYSTALACTITE PENDANTS

Since 1988, Paris-based Maison Margiela has become famous for its collaborative team-led approach and its avant-garde transformation of classic designs. In July 2013, it presented the Maison Margiela Crystalactite for Swarovski at its Paris Haute Couture show. These were groundbreaking Crystal Fusion components inspired by natural stalactite forms and developed in creative partnership with Swarovski. Swarovski presents its interpretation of this innovative cut in pure crystal – the Crystalactite Pendant. Featuring a progressive aesthetic combining partly frosted facets with primeval, irregular

icicle shapes, the vision that originated in our wildest landscapes has now been perfected by one of the most sophisticated design houses. With an easy-to-use hole at the top, the Pendant offers myriad design possibilities for strong, contemporary designs, and for recreating haute-couture looks.

**“Naturally and spontaneously, an imposing crystal emerges from its raw, stony origin, patiently growing into its iconic stalactite shape.”**

6017/G Crystalactite Pendant grand partly frosted

Crystal	
<input type="checkbox"/>	Crystal (001)
Crystal Effects	
Transparent Effects	
<input type="checkbox"/>	Crystal Aurore Boreale V (001 ABV)
<input type="checkbox"/>	Crystal Bermuda Blue P (001 BB) <sup>1</sup>
<input type="checkbox"/>	Crystal Golden Shadow V (001 GSHAV)
<input type="checkbox"/>	Crystal Vitrail Medium P (001 VM) <sup>1</sup>

<sup>1</sup> For details about the protective coating, please refer to the chapter ‘Basic Information.’

**6020 Helix Pendant**



**Size**  
18 mm  
30 mm  
37 mm

**Crystal**

Crystal (001)

**Crystal Effects**

**Transparent Effects**

Crystal Aurore Boreale (001 AB)

Crystal Golden Shadow (001 GSHA)

**6022 XIRIUS Raindrop Pendant**

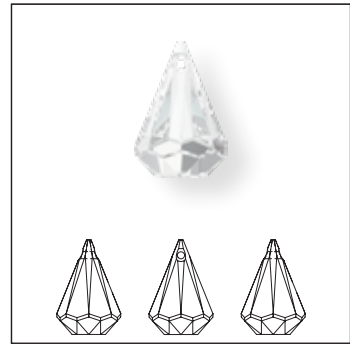

**Size**  
14 mm  
24 mm

**Crystal**

Crystal (001)

**Crystal Effects**

**Transparent Effects**

Crystal Aurore Boreale (001 AB)

**6028 XILION Oval Pendant**

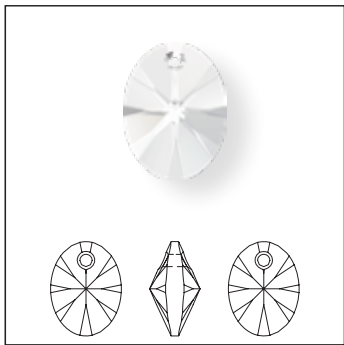

**Size**  
8 mm  
10 mm  
12 mm  
18 mm

**Crystal**

Crystal (001)

**Crystal Effects**

**Transparent Effects**

Crystal Aurore Boreale (001 AB)

Crystal Silver Night (001 SINI)

Crystal Vitrail Light P (001 VL)<sup>1</sup>

**6040 Helios Pendant**

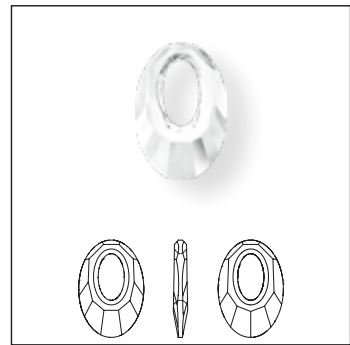

**Size**  
20 mm  
30 mm  
40 mm

**Crystal**

Crystal (001)

**Crystal Effects**

**Transparent Effects**

Crystal Aurore Boreale (001 AB)

Crystal Silver Night (001 SINI)

<sup>1</sup> For details about the protective coating, please refer to the chapter 'Basic Information.'

6049 Flat Disc Pendant

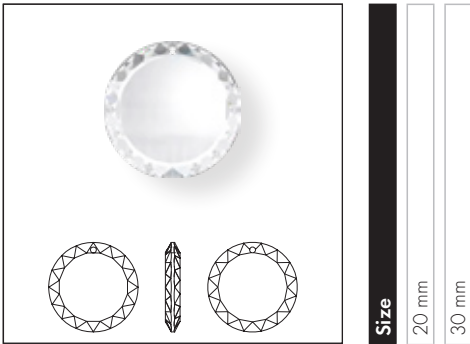

Size

20 mm

30 mm

Crystal

Crystal (001)

6090 Baroque Pendant

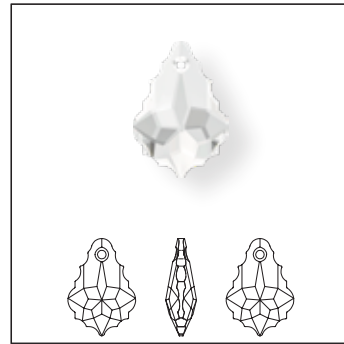

Size

16x11 mm

22x15 mm

Crystal

Crystal (001)

Colors

Plain Colors

Jet (280)

Ruby (501)

Crystal Effects

Transparent Effects

Crystal Aurore Boreale (001 AB)

Crystal Golden Shadow (001 GSHA)

6100 Elegant Pendant

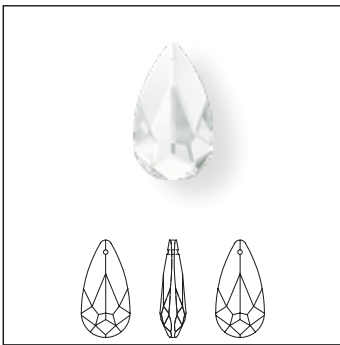

Size

24x12 mm

Crystal

Crystal (001)

Crystal Effects

Transparent Effects

Crystal Aurore Boreale (001 AB)

Crystal Bermuda Blue (001 BB)

Crystal Vitrail Light (001 VL)<sup>1</sup>

Crystal Vitrail Medium (001 VM)<sup>1</sup>

<sup>1</sup> For details about the protective coating, please refer to the chapter 'Basic Information.'

**CORE ASSORTMENT**

**6106** Pear-shaped Pendant



Size	16 mm	22 mm	28 mm	38 mm
------	-------	-------	-------	-------

**Crystal**

Crystal (001)

**Colors**

**Plain Colors**

Amethyst (204)

Aquamarine (202)

Emerald (205)

Golden Topaz (1003)\*

Iris (219)

Jet (280)

Light Amethyst (212)

Light Colorado Topaz (246)

Light Rose (223)

Light Sapphire (211)

Light Siam (227)

Ruby (501)

Scarlet (276)

Smoked Amber (1001)\*

Tanzanite (539)

**Crystal Effects**

**Transparent Effects**

Crystal Antique Pink (001 ANTP)

Crystal Aurore Boreale (001 AB)

Crystal Blue Shade (001 BLSH)

Crystal Golden Shadow (001 GSHA)

Crystal Paradise Shine (001 PARSH)

Crystal Shimmer (001 SHIM)

Crystal Silver Night (001 SINI)

Crystal Silver Shade (001 SSHA)

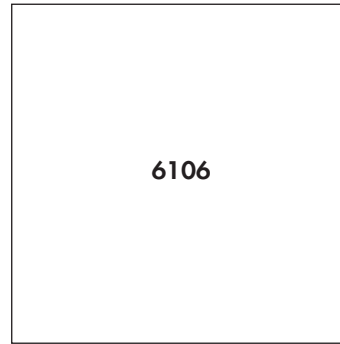

Size	16 mm	22 mm	28 mm	38 mm
------	-------	-------	-------	-------

**Color Effects**

**Transparent Effects**

Amethyst Shimmer (204 SHIM)

Aquamarine Shimmer (202 SHIM)

Emerald Shimmer (205 SHIM)

Light Amethyst Shimmer (212 SHIM)

Light Colorado Topaz Shimmer (246 SHIM)

Light Rose Shimmer (223 SHIM)

Light Sapphire Shimmer (211 SHIM)

\* All colors with a 4-digit color code (i.e. Golden Topaz) are fully customizable with shorter lead times and lower MOQs compared to our 3-digit colors. Please get in touch with the Customer Service for a time and quantity estimation of your desired variant.

◆ Core Assortment

**6128** XILION Mini Pear Pendant

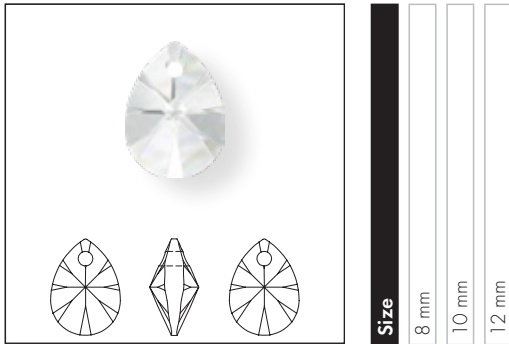

**Size**  
8 mm  
10 mm  
12 mm

**Crystal**

Crystal (001)

**Crystal Effects**

**Transparent Effects**

Crystal Aurore Boreale (001 AB)

Crystal Golden Shadow (001 GSHA)

Crystal Paradise Shine (001 PARSH)

**6210** Lunar Pendant

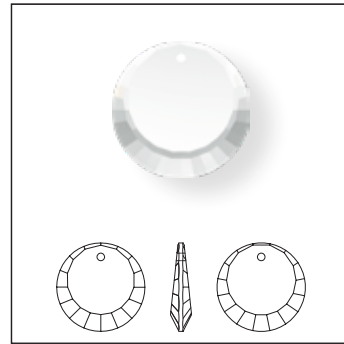

**Size**  
12 mm  
17 mm

**Crystal**

Crystal (001)

**Crystal Effects**

**Transparent Effects**

Crystal Aurore Boreale (001 AB)

**6215** Classic Heart Pendant

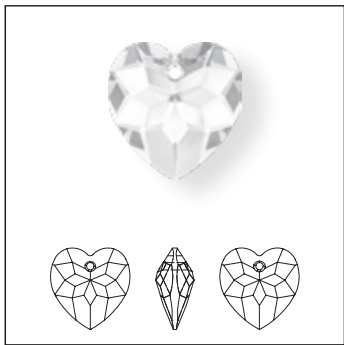

**Size**  
18 mm

**Crystal**

Crystal (001)

**Crystal Effects**

**Transparent Effects**

Crystal Aurore Boreale (001 AB)

Crystal Bermuda Blue P (001 BB)<sup>1</sup>

**6225** Flat Heart Pendant

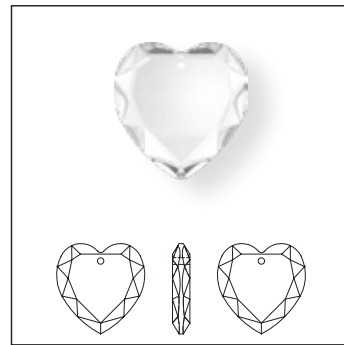

**Size**  
10 mm  
18 mm  
28 mm

**Crystal**

Crystal (001)

<sup>1</sup> For details about the protective coating, please refer to the chapter 'Basic Information.'



**CORE ASSORTMENT**

**6228 XILION Heart Pendant**

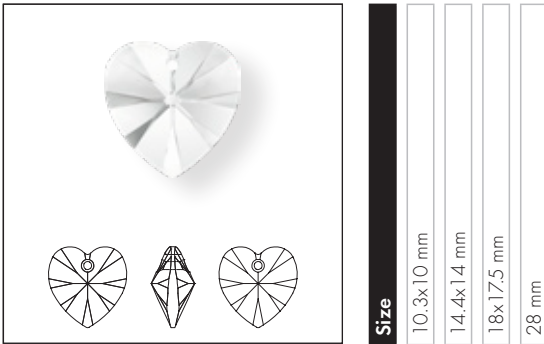

	10.3x10 mm	14.4x14 mm	18x17.5 mm	28 mm
<b>Crystal</b>				
Crystal (001)	◆	◆	◆	■
<b>Colors</b>				
<b>Plain Colors</b>				
Amethyst (204)	◆	◆	◆	
Aquamarine (202)	◆	◆	◆	
Blue Zircon (229)	■			
Emerald (205)	◆	◆	◆	
Fuchsia (502)	■	■		
Golden Topaz (1003)*	■	■		
Iris (219)	■	■	■	
Jet (280)	◆	◆	◆	
Light Amethyst (212)	■	■	■	
Light Colorado Topaz (246)	◆	◆	◆	
Light Rose (223)	◆	◆	◆	
Light Siam (227)	■	■		
Light Topaz (226)	■			
Peridot (214)	■			
Rose (209)	■	■	■	
Sapphire (206)	■			
Scarlet (276)	◆	◆	◆	
Siam (208)	■	■	■	
Smoked Amber (1001)*	■	■		
Violet (371)	■			
<b>Crystal Effects</b>				
<b>Transparent Effects</b>				
Crystal Aurore Boreale (001 AB)	■	■	■	
Crystal Bermuda Blue (001 BB)	■	■	■	
Crystal Bermuda Blue P (001 BB) <sup>1</sup>				■
Crystal Golden Shadow (001 GSHA)	■	■	■	
Crystal Heliotrope (001 HEL)	■	■	■	
Crystal Paradise Shine (001 PARSH)	■	■	■	

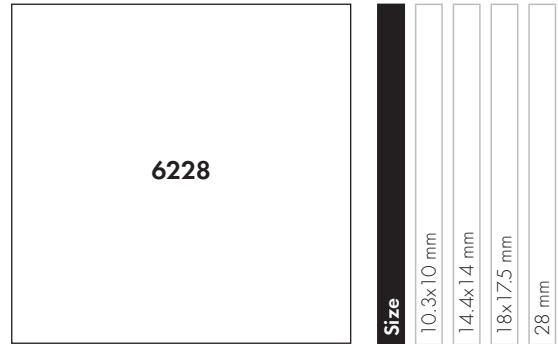

	10.3x10 mm	14.4x14 mm	18x17.5 mm	28 mm
Crystal Shimmer (001 SHIM)	■	■	■	
Crystal Silver Night (001 SINI)	■	■	■	■
Crystal Vitrail Light (001 VL)	■	■	■	
Crystal Vitrail Medium (001 VM)	■	■	■	
<b>Metallic Effects</b>				
Crystal Metallic Sunshine (001 METSH)	■	■		
<b>Color Effects</b>				
<b>Transparent Effects</b>				
Amethyst Shimmer (204 SHIM)	■	■	■	
Aquamarine Aurore Boreale (202 AB)	■	■		
Aquamarine Shimmer (202 SHIM)	■	■	■	
Blue Zircon Aurore Boreale (229 AB)	■			
Emerald Shimmer (205 SHIM)	■	■	■	
Fuchsia Aurore Boreale (502 AB)	■			
Light Amethyst Shimmer (212 SHIM)	■	■	■	
Light Colorado Topaz Shimmer (246 SHIM)	■	■	■	
Light Rose Aurore Boreale (223 AB)	■	■		
Light Rose Shimmer (223 SHIM)	■	■	■	
Light Siam Aurore Boreale (227 AB)	■			
Light Siam Shimmer (227 SHIM)	■	■		
Light Topaz Aurore Boreale (226 AB)	■			
Light Topaz Shimmer (226 SHIM)	■	■	■	
Peridot Aurore Boreale (214 AB)	■			
Rose Aurore Boreale (209 AB)	■	■		
Sapphire Aurore Boreale (206 AB)	■			
Siam Aurore Boreale (208 AB)	■	■	■	
Violet Aurore Boreale (371 AB)	■			

\* All colors with a 4-digit color code (i.e. Golden Topaz) are fully customizable with shorter lead times and lower MOQs compared to our 3-digit colors. Please get in touch with the Customer Service for a time and quantity estimation of your desired variant.

<sup>1</sup> For details about the protective coating, please refer to the chapter 'Basic Information.'

◆ Core Assortment

6240 Wild Heart Pendant

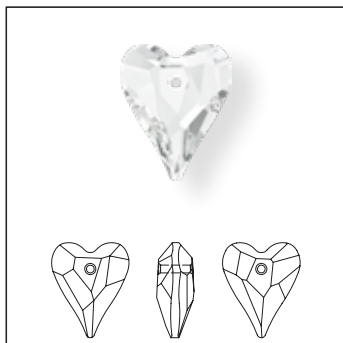

Size
12 mm
17 mm
27 mm

**Crystal**

Crystal (001)

**Crystal Effects**

**Transparent Effects**

Crystal Aurore Boreale (001 AB)

# ”Love Story of the Heart“ by Manish Arora

Since the beginning of his international career, the award-winning, Delhi-based designer Manish Arora has worked creatively with Swarovski. In 2009, he created a memorable collection of crystalline Transfers. One year later, India's best-loved and most prolific design talent renewed his partnership with Swarovski and created a special collection of heart-shaped crystal pendants, which were launched in February 2011. Each individual piece is an expression of love's different emotional states and is named accordingly.

The partnership with Manish Arora is symbolic of how Swarovski engages in mutually rewarding creative partnerships with the world's best and brightest design spirits.

“The heart shape is very close to me because it is the universal symbol of love. I wanted to bring this symbol to life by creating a collection of crystal pendants and I hope people will wear them as a personal expression of the beauty and purity of this emotion.” Manish Arora

**6261** Devoted 2 U Heart

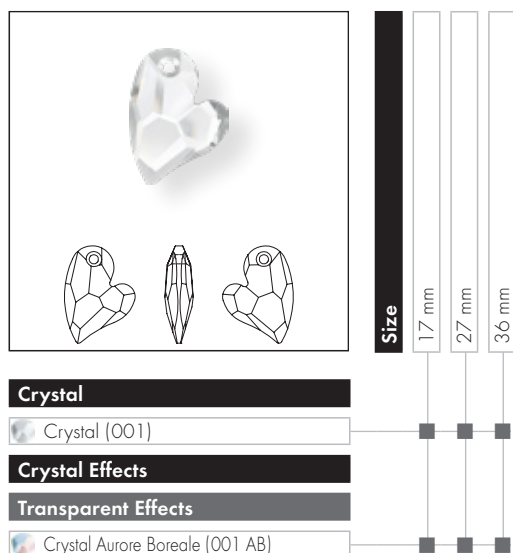

**6264** Truly in Love Heart

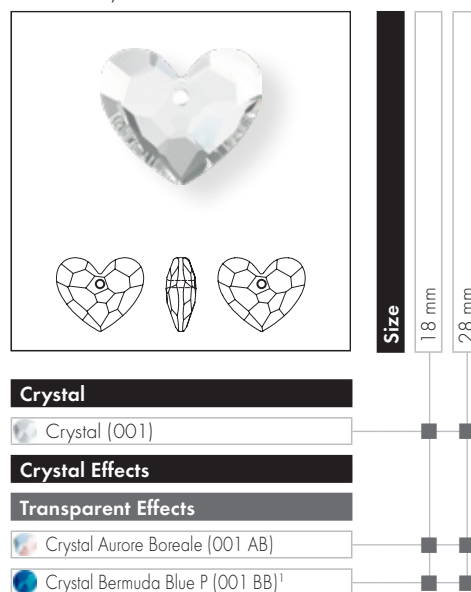

## DESIGNER EDITIONS – DISTINCT PACKAGING

This Designer Edition will be labeled with the “Designer Edition” imprint directly on the packaging.

¹ For details about the protective coating, please refer to the chapter ‘Basic Information.’

**6328** XILION Bi-Cone Pendant

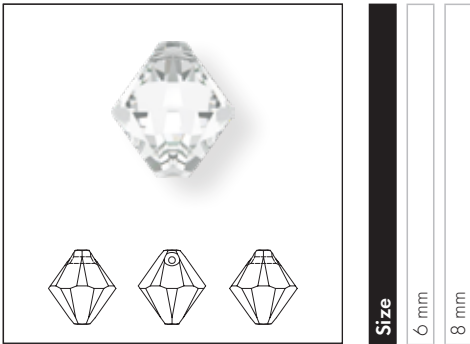

- Crystal**
- Crystal (001)
- Colors**
- Plain Colors**
- Aquamarine (202)
- Light Rose (223)
- Violet (371)
- Crystal Effects**
- Transparent Effects**
- Crystal Aurore Boreale (001 AB)
- Crystal Golden Shadow (001 GSHA)

**6401** Octagon Pendant

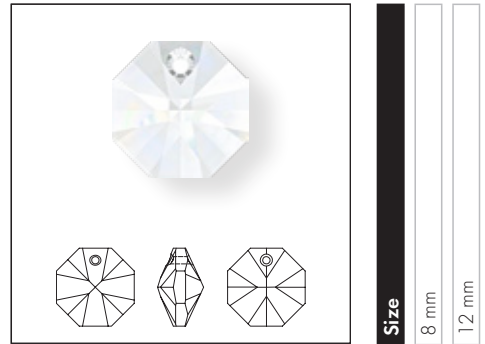

- Crystal**
- Crystal (001)
- Crystal Effects**
- Transparent Effects**
- Crystal Aurore Boreale (001 AB)
- Crystal Golden Shadow (001 GSHA)
- Crystal Silver Shade (001 SSHA)

**CORE ASSORTMENT**

**6428 XILION Pendant**

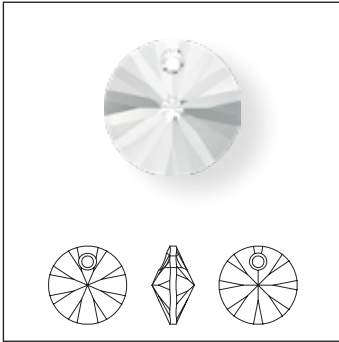

**Size** 6 mm

**6428 XILION Pendant**

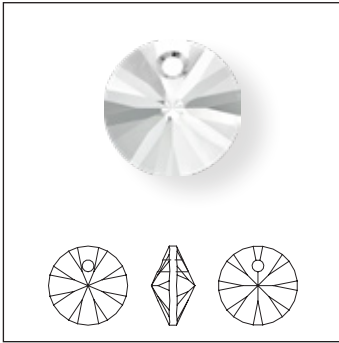

**Size** 8, 12 mm

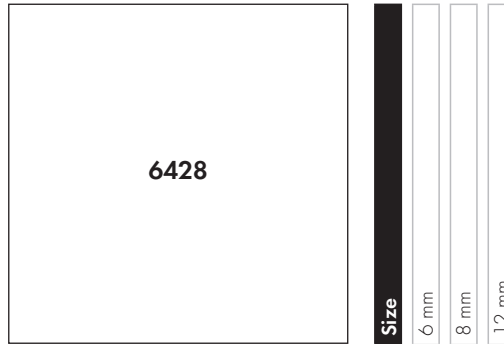

**Crystal**

Crystal (001)

**Colors**

**Plain Colors**

Amethyst (204)

Aquamarine (202)

Denim Blue (266)

Emerald (205)

Golden Topaz (1003)\*

Iris (219)

Jet (280)

Light Colorado Topaz (246)

Light Rose (223)

Light Siam (227)

Light Turquoise (263)

Rose (209)

Scarlet (276)

Siam (208)

Smoked Amber (1001)\*

Violet (371)

**Crystal Effects**

**Transparent Effects**

Crystal Antique Pink (001 ANTP)

Crystal Aurore Boreale (001 AB)

Crystal Blue Shade (001 BLSH)

Crystal Golden Shadow (001 GSHA)

Crystal Paradise Shine (001 PARSH)

Crystal Shimmer (001 SHIM)

Crystal Silver Night (001 SINI)

Crystal Silver Shade (001 SSHA)

**Color Effects**

**Transparent Effects**

Amethyst Shimmer (204 SHIM)

Aquamarine Shimmer (202 SHIM)

Emerald Shimmer (205 SHIM)

Light Colorado Topaz Shimmer (246 SHIM)

Light Rose Shimmer (223 SHIM)

Light Siam Shimmer (227 SHIM)

\* All colors with a 4-digit color code (i.e. Golden Topaz) are fully customizable with shorter lead times and lower MOQs compared to our 3-digit colors. Please get in touch with the Customer Service for a time and quantity estimation of your desired variant.

◆ Core Assortment

6430 Classic Cut Pendant

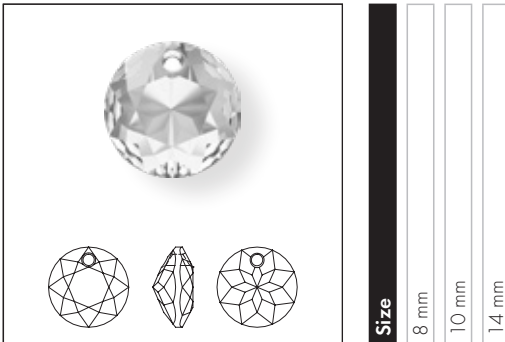

Size  
8 mm  
10 mm  
14 mm

Crystal

Crystal (001)

Colors

Plain Colors

- Amethyst (204)
- Aquamarine (202)
- Emerald (205)
- Jet (280)
- Light Amethyst (212)
- Light Colorado Topaz (246)
- Light Rose (223)
- Light Siam (227)
- Majestic Blue (296)
- Montana (207)
- Peridot (214)
- Rose (209)
- Sapphire (206)
- Scarlet (276)
- Siam (208)
- Topaz (203)

Crystal Effects

Transparent Effects

- Crystal Aurore Boreale (001 AB)
- Crystal Bermuda Blue P (001 BB)<sup>1</sup>
- Crystal Golden Shadow (001 GSHA)
- Crystal Shimmer (001 SHIM)
- Crystal Silver Night (001 SINI)
- Crystal Vitrail Light P (001 VL)<sup>1</sup>
- Crystal Vitrail Medium P (001 VM)<sup>1</sup>

Color Effects

Transparent Effects

- Amethyst Shimmer (204 SHIM)
- Aquamarine Shimmer (202 SHIM)
- Emerald Shimmer (205 SHIM)
- Light Colorado Topaz Shimmer (246 SHIM)
- Light Rose Shimmer (223 SHIM)

6431 Princess Cut Pendant

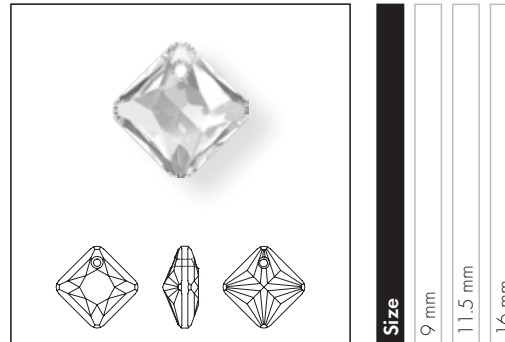

Size  
9 mm  
11.5 mm  
16 mm

Crystal

Crystal (001)

Colors

Plain Colors

- Amethyst (204)
- Aquamarine (202)
- Emerald (205)
- Jet (280)
- Light Amethyst (212)
- Light Colorado Topaz (246)
- Light Rose (223)
- Light Siam (227)
- Majestic Blue (296)
- Montana (207)
- Peridot (214)
- Rose (209)
- Sapphire (206)
- Scarlet (276)
- Siam (208)
- Topaz (203)

Crystal Effects

Transparent Effects

- Crystal Aurore Boreale (001 AB)
- Crystal Bermuda Blue P (001 BB)<sup>1</sup>
- Crystal Golden Shadow (001 GSHA)
- Crystal Shimmer (001 SHIM)
- Crystal Silver Night (001 SINI)
- Crystal Vitrail Light P (001 VL)<sup>1</sup>
- Crystal Vitrail Medium P (001 VM)<sup>1</sup>

Color Effects

Transparent Effects

- Amethyst Shimmer (204 SHIM)
- Aquamarine Shimmer (202 SHIM)
- Emerald Shimmer (205 SHIM)
- Light Colorado Topaz Shimmer (246 SHIM)
- Light Rose Shimmer (223 SHIM)

<sup>1</sup> For details about the protective coating, please refer to the chapter 'Basic Information.'

**6432 Heart Cut Pendant**

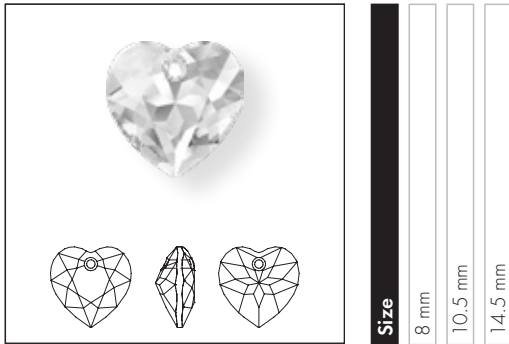

Crystal	8 mm	10.5 mm	14.5 mm
Crystal (001)	■	■	■
<b>Colors</b>			
<b>Plain Colors</b>			
Amethyst (204)	■	■	■
Aquamarine (202)	■	■	■
Emerald (205)	■	■	■
Jet (280)	■	■	■
Light Amethyst (212)	■	■	■
Light Colorado Topaz (246)	■	■	■
Light Rose (223)	■	■	■
Light Siam (227)	■	■	■
Majestic Blue (296)	■	■	■
Montana (207)	■	■	■
Peridot (214)	■	■	■
Rose (209)	■	■	■
Sapphire (206)	■	■	■
Scarlet (276)	■	■	■
Siam (208)	■	■	■
Topaz (203)	■	■	■
<b>Crystal Effects</b>			
<b>Transparent Effects</b>			
Crystal Aurore Boreale (001 AB)	■	■	■
Crystal Bermuda Blue P (001 BB) <sup>1</sup>	■	■	■
Crystal Golden Shadow (001 GSHA)	■	■	■
Crystal Shimmer (001 SHIM)	■	■	■
Crystal Silver Night (001 SINI)	■	■	■
Crystal Vitrail Light P (001 VL) <sup>1</sup>	■	■	■
Crystal Vitrail Medium P (001 VM) <sup>1</sup>	■	■	■
<b>Color Effects</b>			
<b>Transparent Effects</b>			
Amethyst Shimmer (204 SHIM)	■	■	■
Aquamarine Shimmer (202 SHIM)	■	■	■
Emerald Shimmer (205 SHIM)	■	■	■
Light Colorado Topaz Shimmer (246 SHIM)	■	■	■
Light Rose Shimmer (223 SHIM)	■	■	■

**6433 Pear Cut Pendant**

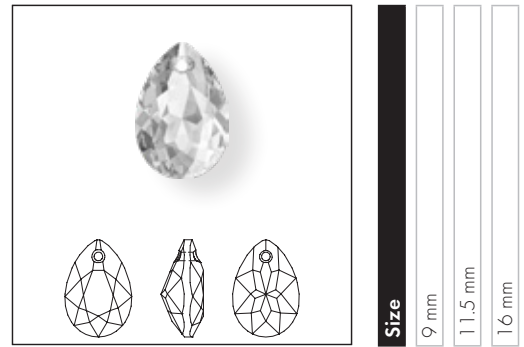

Crystal	9 mm	11.5 mm	16 mm
Crystal (001)	■	■	■
<b>Colors</b>			
<b>Plain Colors</b>			
Amethyst (204)	■	■	■
Aquamarine (202)	■	■	■
Emerald (205)	■	■	■
Jet (280)	■	■	■
Light Amethyst (212)	■	■	■
Light Colorado Topaz (246)	■	■	■
Light Rose (223)	■	■	■
Light Siam (227)	■	■	■
Majestic Blue (296)	■	■	■
Montana (207)	■	■	■
Peridot (214)	■	■	■
Rose (209)	■	■	■
Sapphire (206)	■	■	■
Scarlet (276)	■	■	■
Siam (208)	■	■	■
Topaz (203)	■	■	■
<b>Crystal Effects</b>			
<b>Transparent Effects</b>			
Crystal Aurore Boreale (001 AB)	■	■	■
Crystal Bermuda Blue P (001 BB) <sup>1</sup>	■	■	■
Crystal Golden Shadow (001 GSHA)	■	■	■
Crystal Shimmer (001 SHIM)	■	■	■
Crystal Silver Night (001 SINI)	■	■	■
Crystal Vitrail Light P (001 VL) <sup>1</sup>	■	■	■
Crystal Vitrail Medium P (001 VM) <sup>1</sup>	■	■	■
<b>Color Effects</b>			
<b>Transparent Effects</b>			
Amethyst Shimmer (204 SHIM)	■	■	■
Aquamarine Shimmer (202 SHIM)	■	■	■
Emerald Shimmer (205 SHIM)	■	■	■
Light Colorado Topaz Shimmer (246 SHIM)	■	■	■
Light Rose Shimmer (223 SHIM)	■	■	■

<sup>1</sup> For details about the protective coating, please refer to the chapter 'Basic Information.'



6435 Emerald Cut Pendant

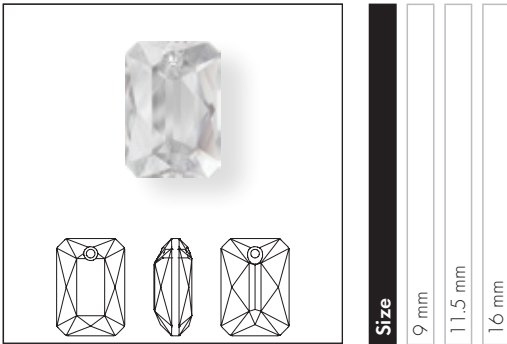

Size  
9 mm  
11.5 mm  
16 mm

**Crystal**

Crystal (001)

**Colors**

**Plain Colors**

- Amethyst (204)
- Aquamarine (202)
- Emerald (205)
- Jet (280)
- Light Amethyst (212)
- Light Colorado Topaz (246)
- Light Rose (223)
- Light Siam (227)
- Majestic Blue (296)
- Montana (207)
- Peridot (214)
- Rose (209)
- Sapphire (206)
- Scarlet (276)
- Siam (208)
- Topaz (203)

**Crystal Effects**

**Transparent Effects**

- Crystal Aurore Boreale (001 AB)
- Crystal Bermuda Blue P (001 BB)<sup>1</sup>
- Crystal Golden Shadow (001 GSHA)
- Crystal Shimmer (001 SHIM)
- Crystal Silver Night (001 SINI)
- Crystal Vitrail Light P (001 VL)<sup>1</sup>
- Crystal Vitrail Medium P (001 VM)<sup>1</sup>

**Color Effects**

**Transparent Effects**

- Amethyst Shimmer (204 SHIM)
- Aquamarine Shimmer (202 SHIM)
- Emerald Shimmer (205 SHIM)
- Light Colorado Topaz Shimmer (246 SHIM)
- Light Rose Shimmer (223 SHIM)

6460 Column Pendant

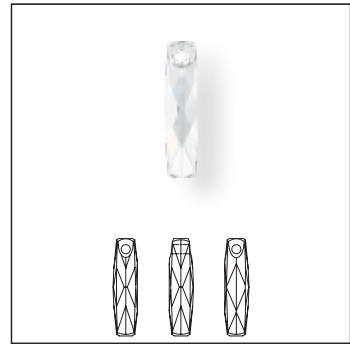

Size  
20 mm

**Crystal**

Crystal (001)

**Crystal Effects**

**Transparent Effects**

- Crystal Aurore Boreale (001 AB)
- Crystal Silver Shade (001 SSHA)

6480 Spike Pendant

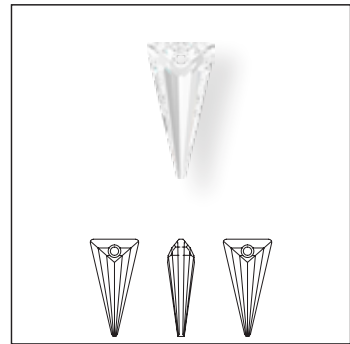

Size  
18 mm  
28 mm  
39 mm

**Crystal**

Crystal (001)

**Colors**

**Plain Colors**

Jet (280)

**Crystal Effects**

**Transparent Effects**

- Crystal Aurore Boreale (001 AB)
- Crystal Bermuda Blue P (001 BB)<sup>1</sup>
- Crystal Blue Shade (001 BLSH)
- Crystal Golden Shadow (001 GSHA)
- Crystal Silver Night (001 SINI)
- Crystal Vitrail Medium P (001 VM)<sup>1</sup>

<sup>1</sup> For details about the protective coating, please refer to the chapter 'Basic Information.'

**6533** Raindrop Pendant

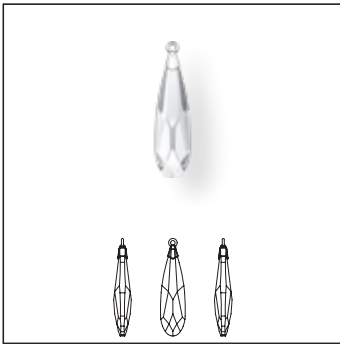

Size
17.5 mm Gold colored plating
23 mm Gold colored plating
33 mm Gold colored plating

**Crystal**

Crystal (001)

**Crystal Effects**

**Transparent Effects**

Crystal Golden Shadow (001 GSHA)

**METALLIC CAP PENDANTS**

**6565** Metallic Cap Pear-shaped Pendant

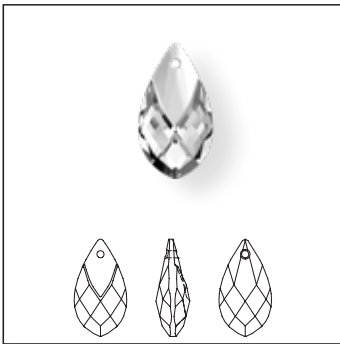

Size
18 mm
22 mm

**Crystal Effects**

**Metallic Effects**

Crystal & Light Chrome Z MCI (001 ITCHZ)

**Color Effects**

**Metallic Effects**

Aquamarine & Light Chrome Z MCI (202 ITCHZ)

6628 XILION Triangle Pendant

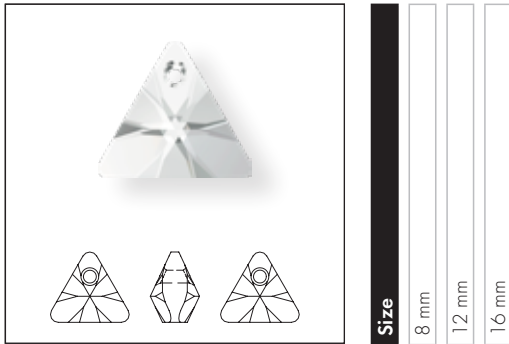

**Size**  
8 mm  
12 mm  
16 mm

- Crystal**
- Crystal (001)
- Crystal Effects**
- Transparent Effects**
- Crystal Aurore Boreale (001 AB)
- Crystal Bermuda Blue P (001 BB)<sup>1</sup>
- Crystal Silver Night (001 SINI)
- Crystal Vitrail Light P (001 VL)<sup>1</sup>

6656 Galactic Vertical Pendant

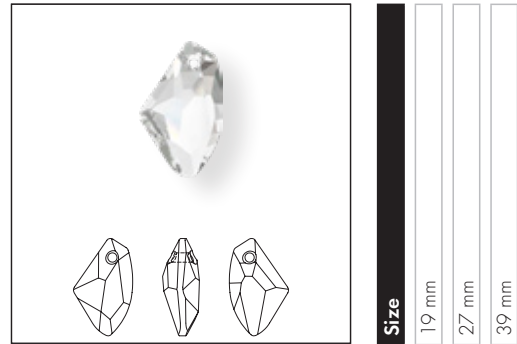

**Size**  
19 mm  
27 mm  
39 mm

- Crystal**
- Crystal (001)
- Colors**
- Plain Colors**
- Aquamarine (202)
- Light Rose (223)
- Peridot (214)
- Tanzanite (539)
- Crystal Effects**
- Transparent Effects**
- Crystal Bermuda Blue P (001 BB)<sup>1</sup>
- Crystal Golden Shadow (001 GSHA)
- Crystal Moonlight (001 MOL)
- Crystal Silver Shade (001 SSHA)

6670 De-Art Pendant

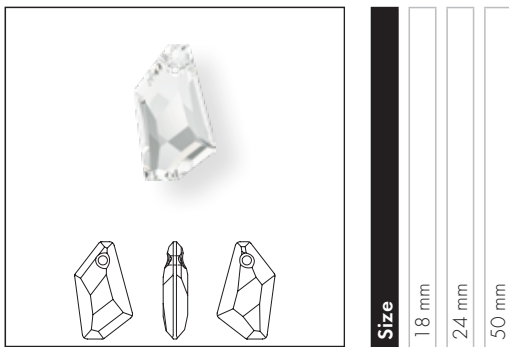

**Size**  
18 mm  
24 mm  
50 mm

- Crystal**
- Crystal (001)
- Colors**
- Plain Colors**
- Aquamarine (202)
- Crystal Effects**
- Transparent Effects**
- Crystal Aurore Boreale (001 AB)
- Crystal Bermuda Blue P (001 BB)<sup>1</sup>
- Crystal Golden Shadow (001 GSHA)
- Crystal Silver Night (001 SINI)

6673 Meteor Pendant

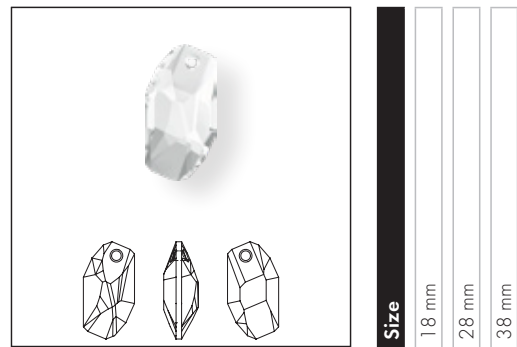

**Size**  
18 mm  
28 mm  
38 mm

- Crystal**
- Crystal (001)
- Colors**
- Plain Colors**
- Light Turquoise (263)
- Crystal Effects**
- Transparent Effects**
- Crystal Aurore Boreale (001 AB)
- Crystal Golden Shadow (001 GSHA)

<sup>1</sup> For details about the protective coating, please refer to the chapter 'Basic Information.'

**6680 Cosmic Pendant**

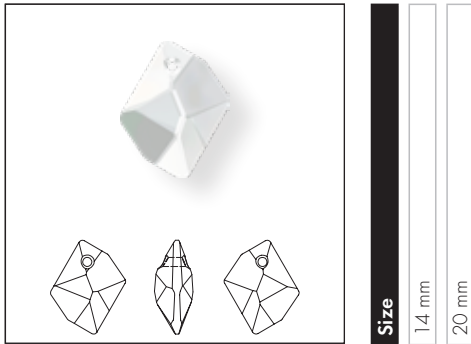

**Size**  
14 mm  
20 mm

**Crystal**

Crystal (001)

**Crystal Effects**

**Transparent Effects**

Crystal Aurore Boreale (001 AB)

Crystal Golden Shadow (001 GSHA)

**6685 Graphic Pendant**



**Size**  
19 mm  
28 mm

**Crystal**

Crystal (001)

**Colors**

**Plain Colors**

Emerald (205)

**Crystal Effects**

**Transparent Effects**

Crystal Aurore Boreale (001 AB)

Crystal Golden Shadow (001 GSHA)

**6690 Wing Pendant**

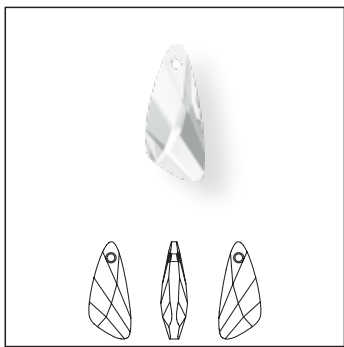

**Size**  
23 mm

**Crystal**

Crystal (001)

**Colors**

**Plain Colors**

Capri Blue (243)

**Crystal Effects**

**Transparent Effects**

Crystal Aurore Boreale (001 AB)

Crystal Silver Night (001 SINI)

**6696 Urban Pendant**

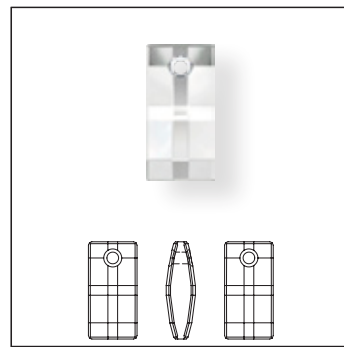

**Size**  
20 mm  
30 mm

**Crystal**

Crystal (001)

**Crystal Effects**

**Transparent Effects**

Crystal Aurore Boreale (001 AB)

Crystal Bermuda Blue P (001 BB)<sup>1</sup>

Crystal Silver Night (001 SINI)

<sup>1</sup> For details about the protective coating, please refer to the chapter 'Basic Information.'

6704 Snowflake Pendant

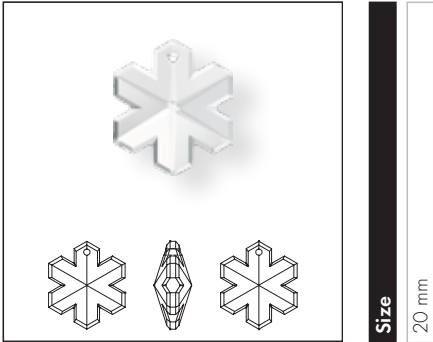

Size  
20 mm

- Crystal**
- Crystal (001)
- Crystal Effects**
- Transparent Effects**
- Crystal Aurore Boreale (001 AB)

6714 Star Pendant

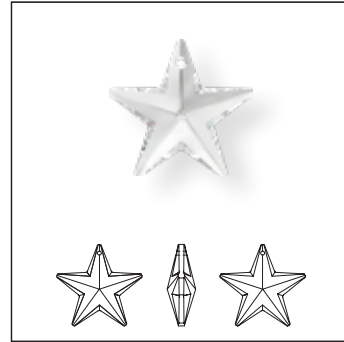

Size  
20 mm  
28 mm  
40 mm

- Crystal**
- Crystal (001)
- Crystal Effects**
- Transparent Effects**
- Crystal Aurore Boreale (001 AB)

6721 Starfish Pendant



Size  
16 mm  
20 mm  
28 mm

- Crystal**
- Crystal (001)
- Crystal Effects**
- Transparent Effects**
- Crystal Aurore Boreale (001 AB)
- Crystal Bermuda Blue P (001 BB)<sup>1</sup>

<sup>1</sup> For details about the protective coating, please refer to the chapter 'Basic Information.'

# Ocean Mysteries designed by Céline Cousteau

**Design Story:** A love for the sea runs through her veins: Céline Cousteau is a celebrated filmmaker, humanitarian, and environmentalist, as well as the granddaughter of legendary ocean explorer Jacques-Yves Cousteau. She presents her first ever crystal designs for Swarovski, inspired by one of her favorite places, the depths of the ocean. Taking inspiration from nature itself and leaving its

beauty unaltered, her stunningly life-like creatures are not only captivating and spellbinding, they also draw attention toward the mysterious, mostly unseen, and unexplored world beneath the ocean's surface on which all ocean life depends. These mysteries need to be protected for future generations, both above and below the water.

**6731** Sea Snail Pendant partly frosted

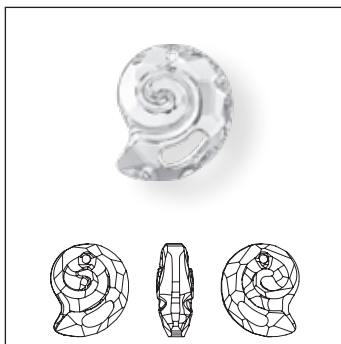

**Size** 14 mm

**6731** Sea Snail Pendant partly frosted



**Size** 28 mm

6731

<b>Crystal</b>	Crystal (001)		
<b>Crystal Effects</b>	Transparent Effects		
<b>Crystal Effects</b>	Crystal Aurore Boreale (001 AB)		

Size

14 mm
  28 mm

6735 Leaf Pendant

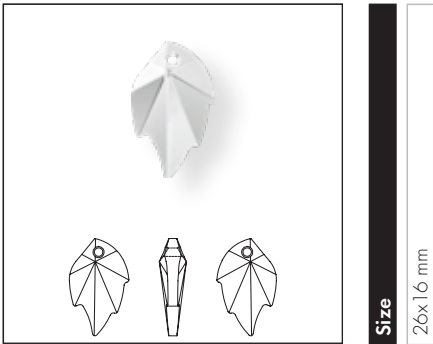

Size

26x16 mm

Crystal

Crystal (001)

Crystal Effects

Transparent Effects

Crystal Aurore Boreale (001 AB)

Crystal Golden Shadow (001 GSHA)

6744 Flower Pendant

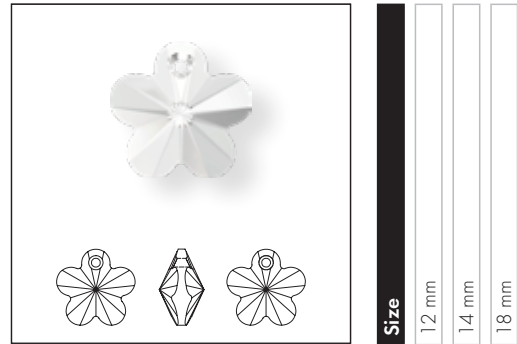

Size

12 mm

14 mm

18 mm

Crystal

Crystal (001)

Crystal Effects

Transparent Effects

Crystal Aurore Boreale (001 AB)

6748 Edelweiss Pendant

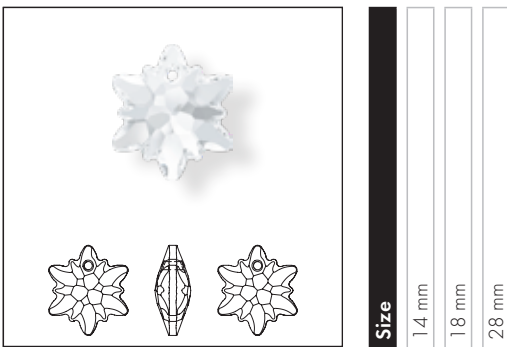

Size

14 mm

18 mm

28 mm

Crystal

Crystal (001)

Crystal Effects

Transparent Effects

Crystal Aurore Boreale (001 AB)

6864 Cross Pendant

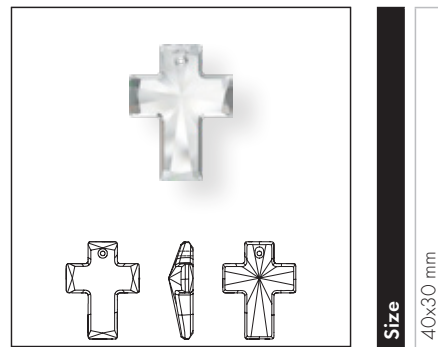

Size

40x30 mm

Crystal

Crystal (001)

Crystal Effects

Transparent Effects

Crystal Aurore Boreale V (001 ABV)



**6866** Square Cross Pendant



**Size**

20 mm

**Crystal**

Crystal (001)

**Crystal Effects**

**Transparent Effects**

Crystal Aurore Boreale (001 AB)

# Product Details

Article Size	Packing Unit = Minimum Order Quantity in Pieces	Average Net Weight in Gram per Packing Unit Crystal (001)	Average Gross Weight in Gram per Packing Unit Crystal (001)
<b>6000</b>			
11x5.5 mm	288	99.8	123.1
13x6.5 mm	288	156.9	197.5
15x7.5 mm	144	129.8	153.4
22x11 mm	48	129.4	151.3
<b>6002</b>			
10x7 mm	144	91.4	109.3
15x11.5 mm	72	175.4	197.3
<b>6007</b>			
7x4 mm	360	46.7	55.8
9x5 mm	288	77.1	104.2
<b>6010</b>			
11x5.5 mm	144	57.4	75.9
13x6.5 mm	144	91.1	109.0
17x8.5 mm	36	57.3	77.2
21x10.5 mm	24	66.3	83.4
<b>6015</b>			
17 mm	72	93.2	111.5
21 mm	48	105.9	129.3
<b>6017/G</b>			
30 mm	12	25.0	45.6
56 mm	6	67.5	91.4
<b>6020</b>			
18 mm	36	49.7	72.1
30 mm	12	74.3	95.5
37 mm	6	76.4	82.5
<b>6022</b>			
14 mm	72	77.2	97.0
24 mm	24	133.9	155.5
<b>6028</b>			
8 mm	144	31.8	40.9
10 mm	192	71.0	97.7
12 mm	108	68.9	92.9
18 mm	72	146.5	170.3
<b>6040</b>			
20 mm	72	66.3	92.8
30 mm	30	85.4	116.4
40 mm	6	41.7	61.4
<b>6049</b>			
20 mm	72	170.5	200.4
30 mm	24	166.7	209.2
<b>6090</b>			
16x11 mm	72	55.8	75.8
22x15 mm	48	102.2	136.7
<b>6100</b>			
24x12 mm	36	54.5	83.9

Article Size	Packing Unit = Minimum Order Quantity in Pieces	Average Net Weight in Gram per Packing Unit Crystal (001)	Average Gross Weight in Gram per Packing Unit Crystal (001)
<b>6106</b>			
16 mm	144	129.9	158.3
22 mm	96	208.1	248.5
28 mm	36	171.8	201.1
38 mm	9	91.1	121.6
<b>6128</b>			
8 mm	144	23.2	34.0
10 mm	144	52.3	80.0
12 mm	144	81.8	101.3
<b>6210</b>			
12 mm	144	67.8	90.9
17 mm	72	98.8	122.0
<b>6215</b>			
18 mm	72	183.2	210.5
<b>6225</b>			
10 mm	144	48.3	68.4
18 mm	24	41.6	59.0
28 mm	24	160.7	206.2
<b>6228</b>			
10.3x10 mm	288	124.6	152.6
14.4x14 mm	144	181.4	210.5
18x17.5 mm	72	188.0	211.7
28 mm	16	124.0	158.7
<b>6240</b>			
12 mm	108	63.3	83.5
17 mm	72	116.4	137.0
27 mm	24	142.6	147.8
<b>6261</b>			
17 mm	48	48.2	76.6
27 mm	20	77.0	102.6
36 mm	12	112.5	135.3
<b>6264</b>			
18 mm	48	93.4	109.1
28 mm	16	93.7	118.2
<b>6328</b>			
6 mm	360	78.5	89.5
8 mm	288	153.2	173.2
<b>6401</b>			
8 mm	288	106.8	123.8
12 mm	144	164.9	182.7
<b>6428</b>			
6 mm	720	80.1	89.5
8 mm	144	37.4	46.7
12 mm	144	121.8	141.6
<b>6430</b>			
8 mm	72	23.7	42.1
10 mm	48	31.7	51.9
14 mm	24	40.9	61.6

Article Size	Packing Unit = Minimum Order Quantity in Pieces	Average Net Weight in Gram per Packing Unit Crystal (001)	Average Gross Weight in Gram per Packing Unit Crystal (001)
<b>6431</b>			
9 mm	72	22.1	40.5
11.5 mm	48	30.1	51.1
16 mm	24	41.9	62.6
<b>6432</b>			
8 mm	72	21.9	40.3
10.5 mm	48	31.6	51.8
14.5 mm	24	40.0	60.7
<b>6433</b>			
9 mm	72	18.1	33.2
11.5 mm	48	28.8	46.1
16 mm	36	54.0	71.9
<b>6435</b>			
9 mm	72	24.2	42.8
11.5 mm	48	35.1	53.7
16 mm	24	46.1	64.7
<b>6460</b>			
20 mm	72	60.3	83.1
<b>6480</b>			
18 mm	48	42.7	64.1
28 mm	36	101.6	130.5
39 mm	16	105.6	133.7
<b>6533</b>			
17.5 mm	36	11.6	31.8
23 mm	24	14.6	35.4
33 mm	12	22.7	43.4
<b>6565</b>			
18 mm	36	43.6	64.2
22 mm	24	54.9	75.0
<b>6628</b>			
8 mm	288	72.6	72.8
12 mm	144	101.6	126.9
16 mm	72	128.2	155.1
<b>6656</b>			
19 mm	48	72.3	94.2
27 mm	30	126.1	159.6
39 mm	6	61.8	82.0
<b>6670</b>			
18 mm	72	68.4	104.6
24 mm	48	105.5	161.9
50 mm	6	104.7	126.8
<b>6673</b>			
18 mm	48	59.7	80.7
28 mm	20	89.0	112.2
38 mm	6	69.5	87.1

Article Size	Packing Unit = Minimum Order Quantity in Pieces	Average Net Weight in Gram per Packing Unit Crystal (001)	Average Gross Weight in Gram per Packing Unit Crystal (001)
<b>6680</b>			
14 mm	144	118.7	145.1
20 mm	72	167.5	191.1
<b>6685</b>			
19 mm	48	104.5	127.4
28 mm	24	168.7	175.4
<b>6690</b>			
23 mm	36	54.5	88.6
<b>6696</b>			
20 mm	24	53.5	70.6
30 mm	10	59.6	83.3
<b>6704</b>			
20 mm	48	131.4	155.0
<b>6714</b>			
20 mm	48	48.2	73.1
28 mm	24	112.5	156.1
40 mm	6	56.1	87.4
<b>6721</b>			
16 mm	72	105.1	131.7
20 mm	30	76.8	113.6
28 mm	12	66.3	93.7
<b>6731</b>			
14 mm	36	35.1	64.0
28 mm	8	76.4	98.2
<b>6735</b>			
26x16 mm	30	73.3	110.0
<b>6744</b>			
12 mm	144	118.7	145.4
14 mm	144	172.9	204.5
18 mm	72	174.8	207.2
<b>6748</b>			
14 mm	72	65.3	90.0
18 mm	48	88.3	110.2
28 mm	18	115.7	145.4
<b>6864</b>			
40x30 mm	9	109.2	142.2
<b>6866</b>			
20 mm	72	249.5	272.8

