



TRANSFERS

Transfers are ideal for Hotfix application on all kinds of textiles. They are available in a large range of motifs and numbers of rows and are made up of different articles from the Flat Back Hotfix assortment.

Featuring designs from our in-house design team, they can include XIRIUS and XILLION Roses, or Creation Stones, as well as Metallics and Cabochons.

With Transfers Unlimited, Swarovski presents a spectacular new production technology that makes it possible to combine up to 18 different elements in a single motif, doubling existing design possibilities. The Transfer motifs offered are divided into two categories: the Standard Collection and the Crystal Inspiration Collection, meeting all needs in the targeted segments, such as womenswear and sportswear, casualwear, and footwear.

| | |
|-----|--------------------------------|
| 506 | Standard Collection |
| 518 | Crystal Inspiration Collection |
| 542 | Crystal-It Infinity |

ALPHABETICAL ORDER

Amethyst (204)
 Aquamarine (202)
 Black Diamond (215)
 Black Diamond Dorado Z (215 DORZ)
 Black Diamond Light Chrome Z (215 LTCHZ)
 Black Diamond Shimmer (215 SHIM)
 Blue Zircon (229)
 Blue Zircon Satin (229 SAT)
 Blue Zircon Shimmer (229 SHIM)
 Blush Rose (257)
 Burgundy (515)
 Burgundy Dorado Z (515 DORZ)
 Burgundy Light Chrome Z (515 LTCHZ)
 Capri Blue (243)
 Chalkwhite (279)
 Chrysolite (238)
 Citrine (249)
 Citrine Shimmer (249 SHIM)
 Cobalt (369)
 Cobalt Shimmer (369 SHIM)
 Crystal (001)
 Crystal Shimmer (001 SHIM)
 Crystal Army Green DeLite (001 L130D)*
 Crystal Aurore Boreale (001 AB)
 Crystal Azure Blue (001 L112S)
 Crystal Bermuda Blue (001 BBL)
 Crystal Black Patina (001 BLAPA)
 Crystal Blue Shade (001 BLSH)
 Crystal Bronze Pearl (001 295)
 Crystal Burgundy DeLite (001 L132D)*
 Crystal Buttercup (001 L124S)
 Crystal Cappuccino DeLite (001 L133D)*
 Crystal Copper (001 COP)
 Crystal Creampearl (001 291)
 Crystal Dark Grey Pearl (001 617)
 Crystal Dark Grey (001 L111S)
 Crystal Dark Red (001 L108S)
 Crystal Dorado (001 DOR)
 Crystal Dorado Z (001 DORZ)
 Crystal Golden Shadow (001 GSHA)
 Crystal Halfix Transparent (001 HFT)²
 Crystal Iridescent Dove Grey Pearl (001 954)
 Crystal Iridescent Green (001 IRIG)
 Crystal Ivory Cream (001 L106S)
 Crystal Light Chrome (001 LTCH)
 Crystal Light Chrome Z (001 LTCHZ)
 Crystal Light Coral (001 L116S)
 Crystal Light Grey DeLite (001 L129D)*
 Crystal Light Grey Pearl (001 616)
 Crystal Lilac (001 L126S)
 Crystal Lime (001 L125S)
 Crystal Luminous Green (001 LUMG)
 Crystal Meridian Blue (001 MBL)

Crystal Metallic Blue (001 METBL)
 Crystal Metallic Light Gold (001 MLGLD)
 Crystal Metallic Sunshine (001 METSH)
 Crystal Mint Green (001 L115S)
 Crystal Moonlight (001 MOL)
 Crystal Nacre (001 191)
 Crystal Ochre DeLite (001 L131D)*
 Crystal Paradise Shine (001 PARSH)*
 Crystal Peony Pink (001 L113S)
 Crystal Rosaline Pearl (001 294)
 Crystal Rainbow Dark (001 RABDK)
 Crystal Rose Gold (001 ROGL)
 Crystal Rose Gold Pearl (001 769)
 Crystal Rose Patina (001 ROSPA)
 Crystal Royal Blue (001 L110S)
 Crystal Royal Green (001 L109S)
 Crystal Royal Red (001 L107S)
 Crystal Scarabaeus Green (001 SCGR)***
 Crystal Silver Night (001 SINI)
 Crystal Silver Shade (001 SSHA)
 Crystal Summer Blue (001 L114S)
 Crystal Transmission Halfix Transparent (001 TRA HFT)
 Crystal Vintage Gold Pearl (001 651)
 Crystal Volcano (001 VOL)
 Crystal White Pearl (001 650)
 Dark Indigo (288)
 Denim Blue (266)
 Denim Blue Dorado Z (266 DORZ)
 Denim Blue Light Chrome Z (266 LTCHZ)
 Emerald (205)
 Erinite (360)
 Erinite Shimmer (360 SHIM)
 Fern Green (291)
 Fireopal (237)²
 Fuchsia (502)
 Fuchsia Shimmer (502 SHIM)
 Graphite (253)
 Greige (284)
 Greige Dorado Z (284 DORZ)
 Greige Light Chrome Z (284 LTCHZ)
 Hyacinth (236)
 Hyacinth Shimmer (236 SHIM)
 Indian Pink (289)
 Indian Siam (327)²
 Jet (280)
 Jet Aurore Boreale (280 AB)
 Jet Dorado Z (280 DORZ)
 Jet Hematite (280 HEM)
 Jet Light Chrome Z (280 LTCHZ)
 Jet Nut (280 NUT)
 Jonquil (213)
 Jonquil Aurore Boreale (213 AB)
 Khaki (550)

Khaki Dorado Z (550 DORZ)
 Khaki Light Chrome Z (550 LTCHZ)
 Light Amethyst (212)
 Light Colorado Topaz (246)
 Light Colorado Topaz Shimmer (246 SHIM)
 Light Grey Opal (383)
 Light Peach (362)
 Light Rose (223)
 Light Rose Aurore Boreale (223 AB)
 Light Sapphire (211)
 Light Sapphire Shimmer (211 SHIM)
 Light Siam (227)
 Light Siam Aurore Boreale (227 AB)
 Light Siam Dorado Z (227 DORZ)
 Light Siam Light Chrome Z (227 LTCHZ)
 Light Siam Shimmer (227 SHIM)
 Light Silk (261)
 Light Topaz (226)
 Light Topaz Shimmer (226 SHIM)
 Light Turquoise (263)
 Majestic Blue (296)¹
 Montana (207)
 Olivine (228)
 Pacific Opal (390)
 Padparadscha (542)
 Peridot (214)
 Peridot Shimmer (214 SHIM)
 Provence Lavender (283)
 Purple Velvet (277)
 Rose (209)
 Rose Peach (262)
 Ruby (501)
 Sapphire (206)
 Sapphire Aurore Boreale (206 AB)
 Sapphire Satin (206 SAT)
 Scarlet (276)
 Siam (208)
 Siam Shimmer (208 SHIM)
 Silk (391)
 Silk Shimmer (391 SHIM)
 Smoked Topaz (220)
 Sunflower (292)
 Tangerine (259)
 Tangerine Shimmer (259 SHIM)
 Tanzanite (539)
 Topaz (203)
 Topaz Shimmer (203 SHIM)
 Vintage Rose (319)
 White Opal (234)
 White Opal Dorado Z (234 DORZ)
 White Opal Light Chrome Z (234 LTCHZ)
 Yellow Opal (231)

For details on available colors and effects for each article within the product groups, please see the product matrix of the respective item in the Collection 2018.

For color and effect samples, please see the corresponding color chart.

The plating resistance of effects is tested according to Swarovski's plating guidelines (SWAROVSKI-PROFESSIONAL.COM). Customers are advised to carry out their own tests if their plating parameters diverge from Swarovski plating guidelines.

* Crystals are not resistant to plating and similar processing.

** Crystals are resistant to plating only if they are F-foiled.

*** designed by Jean Paul Gaultier

¹ Majestic Blue's intense ultramarine hue is difficult to recreate accurately in print due to the fact that the CMYK color spectrum is used in the printing process.

In order to get a truer impression of its color, please use RGB digital pictures or, ideally, ask for actual samples.

² Only available in limited sizes.

³ In these colors art. 2088 is available as a foiled or unfoiled version.

Classic Colors/Effects: This color range offers a wide choice of traditional Swarovski crystal colors and effects.

Exclusive Colors/Effects: This color range is offered exclusively by Swarovski.

Colors and effects can appear different when illuminated with different light sources. Swarovski uses standard light source D50 for color decision and comparison. Slight changes in shades are unavoidable. Colors may vary according to cut and foiling.

The composition of Advanced Crystal is compliant with regulatory industry norms and laws regarding the restriction or prohibition of certain substances in the most relevant segments of our customers. Please note that the compliance of the crystal colors Citrine, Fireopal, Hyacinth, Light Siam, Siam, and Yellow Opal varies according to certain industry regulations. Those regulations are indicated with * in the compliance overview. Indian Siam and Scarlet (option to Lt. Siam) conform to all CLEAR-lists.

For further information please visit SWAROVSKI-PROFESSIONAL.COM

FLAT BACKS FOR TRANSFERS

SUMMARY

1 2



2000 A HF
SS 3



2034 A HF
SS 10, 20, 48



2035 M HF
6, 10 mm



CORE ASSORTMENT
2038 A HF
SS 5, 6, 8, 10



2038/I A HF
SS 10



CORE ASSORTMENT
2078 A HF
SS 12, 16, 20, 30, 34,
40, 48



2078/H A HF
SS 16, 20, 34



2078/I A HF
SS 16, 20, 34



2080/4 HF
SS 10, 16, 34



2080/H M HF
SS 34



2081/2 HF
SS 16, 34



CORE ASSORTMENT
2200 M HF
4x2, 8x4 mm

1 2



2200/I M HF
8x4 mm



2201 M HF
8x3.5, 14x6 mm



2205 M HF
7.5, 10, 14 mm



2208/4 HF
6x3.5, 8x4.5, 10x5.5 mm



CORE ASSORTMENT
2300 M HF
8x4.8 mm



2300/I M HF
8x4.8 mm



2303 M HF
8x5, 14x9 mm



2304 M HF
10x2.8 mm



2308/4 HF
6x3.5, 8x5, 10x6 mm



CORE ASSORTMENT
2400 M HF
2.2, 3, 4, 6, 10 mm



2402 M HF
4, 6, 10 mm



2403 M HF
4, 6, 10 mm

1 2



2408/4 HF
4, 6, 8 mm



2493 M HF
8, 10, 12 mm



2494 M HF
6, 8, 10.5 mm



2510 M HF
5x2.5 mm



2555 M HF
8x2.6, 12x4, 15x5 mm



2602 M HF
8x5.5, 14x10 mm



2610 M HF
6x4 mm



2711 M HF
3.3, 6 mm



2711/I M HF
6 mm



2714 M HF
6, 10 mm



2728 M HF
SS 10, 16, 20, 34



2738 M HF
10x5, 12x6 mm

1 2



2739 M HF
5.8x5.3, 7x6.5 mm

1 2



2856 M HF
10x7.5, 14x10.5, 18x14 mm



2740 M HF
8.3x8.3, 10x10 mm



2858 M HF
6x4.5 mm



2753 M HF
10, 14 mm



2770 M HF
6x3.5 mm



2771 M HF
6.4x4.2, 8.6x5.6,
12.9x8.3 mm



2772 M HF
6.5x2.1, 8.6x2.8,
12.9x4.2 mm



2773 M HF
5x3, 6.6x3.9,
9.9x5.9 mm



2788 M HF
8, 10 mm



2808 M HF
6, 10 mm



2813 M HF
8x5.5 mm



2817 M HF
5 mm



2855 M HF
8 mm

FLAT BACKS HOTFIX

2000 Rose Hotfix

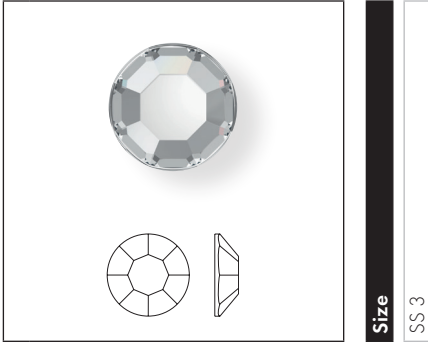

Size
SS 3

- Crystal**
- Crystal A HF (001)
- Colors**
- Plain Colors**
- Amethyst A HF (204)
- Aquamarine A HF (202)
- Black Diamond A HF (215)
- Jet A HF (280)
- Light Colorado Topaz A HF (246)
- Light Rose A HF (223)
- Montana A HF (207)
- Peridot A HF (214)
- Smoked Topaz A HF (220)
- Crystal Effects**
- Transparent Effects**
- Crystal AB A HF (001 AB)
- Crystal Golden Shadow A HF (001 GSHA)
- Crystal Silver Shade A HF (001 SSHA)
- Color Effects**
- Metallic Effects**
- Jet Hematite A HF (280 HEM)

2034 Concise Flat Back

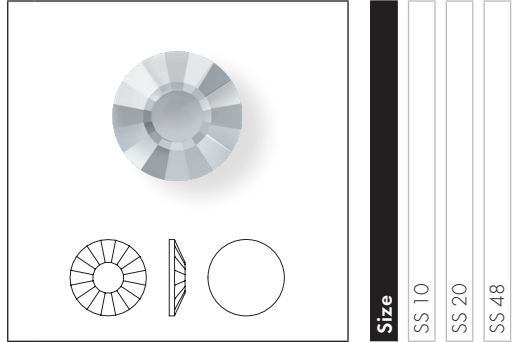

Size
SS 10
SS 20
SS 48

- Crystal**
- Crystal A HF (001)
- Colors**
- Plain Colors**
- Jet A HF (280)
- Light Siam A HF (227)
- Crystal Effects**
- Transparent Effects**
- Crystal AB A HF (001 AB)
- Crystal Golden Shadow A HF (001 GSHA)
- Metallic Effects**
- Crystal Light Chrome A HF (001 LTCH)
- Crystal Patina Effect**
- Crystal Black Patina A HF (001 BLAPA)
- Crystal Rose Patina A HF (001 ROSPA)
- Color Effects**
- Transparent Effects**
- Light Siam AB A HF (227 AB)

FLAT BACKS FOR TRANSFERS

CREATION STONES

2035 Chessboard Circle

Size
6 mm
10 mm

Crystal
Crystal M HF (001)

Crystal Effects

Transparent Effects
Crystal AB M HF (001 AB)

CORE ASSORTMENT

2038 XILION Rose Hotfix

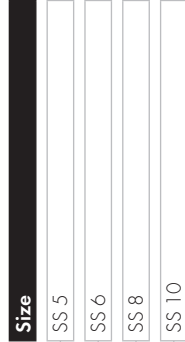
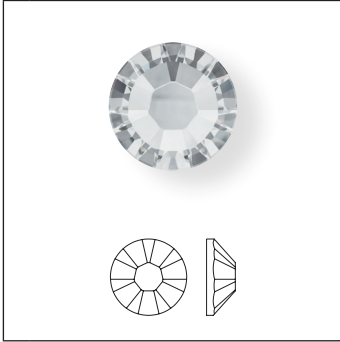

Crystal

- Crystal A HF (001)
- Crystal Hotfix Transparent (001 HFT)

Colors

Plain Colors

- Amethyst A HF (204)
- Aquamarine A HF (202)
- Black Diamond A HF (215)
- Blue Zircon A HF (229)
- Blush Rose A HF (257)
- Burgundy A HF (515)
- Capri Blue A HF (243)
- Chalkwhite A HF (279)
- Chrysolite A HF (238)
- Citrine A HF (249)
- Cobalt A HF (369)
- Dark Indigo A HF (288)
- Denim Blue A HF (266)
- Emerald A HF (205)
- Erinite A HF (360)
- Fern Green A HF (291)
- Fireopal A HF (237)
- Fuchsia A HF (502)
- Graphite A HF (253)
- Greige A HF (284)
- Hyacinth A HF (236)
- Indian Pink A HF (289)
- Indian Siam A HF (327)
- Jet A HF (280)
- Jonquil A HF (213)
- Khaki A HF (550)
- Light Amethyst A HF (212)
- Light Colorado Topaz A HF (246)
- Light Peach A HF (362)
- Light Rose A HF (223)
- Light Sapphire A HF (211)
- Light Siam A HF (227)
- Light Silk A HF (261)
- Light Topaz A HF (226)
- Light Turquoise A HF (263)

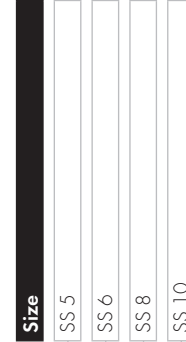
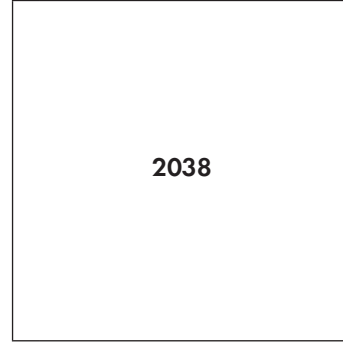

- Majestic Blue A HF (296)
 - Montana A HF (207)
 - Olivine A HF (228)
 - Padparadscha A HF (542)
 - Peridot A HF (214)
 - Provence Lavender A HF (283)
 - Purple Velvet A HF (277)
 - Rose A HF (209)
 - Rose Peach A HF (262)
 - Ruby A HF (501)
 - Sapphire A HF (206)
 - Scarlet A HF (276)
 - Siam A HF (208)
 - Silk A HF (391)
 - Smoked Topaz A HF (220)
 - Sunflower A HF (292)
 - Tangerine A HF (259)
 - Tanzanite A HF (539)
 - Topaz A HF (203)
 - Vintage Rose A HF (319)
- Opal Colors**
- Light Grey Opal A HF (383)
 - Pacific Opal A HF (390)
 - White Opal A HF (234)
 - Yellow Opal A HF (231)
- Crystal Effects**
- Transparent Effects**
- Crystal AB A HF (001 AB)
 - Crystal Blue Shade A HF (001 BLSH)
 - Crystal Copper A HF (001 COP)
 - Crystal Golden Shadow A HF (001 GSHA)
 - Crystal Luminous Green A HF (001 LUMG)
 - Crystal Meridian Blue A HF (001 MBL)
 - Crystal Moonlight A HF (001 MOL)
 - Crystal Paradise Shine A HF (001 PARSH)
 - Crystal Silver Night A HF (001 SINI)
 - Crystal Silver Shade A HF (001 SSHA)
 - Crystal Transmission HFT (001 TRA HFT)
 - Crystal Volcano A HF (001 VOL)

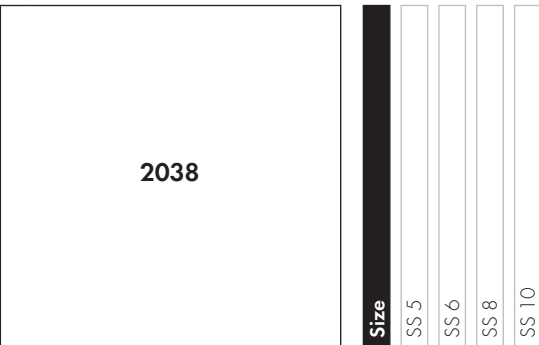

2038

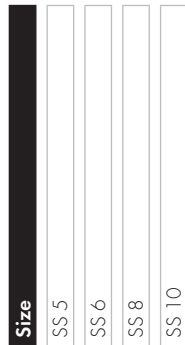

Metallic Effects

- Crystal Dorado A HF (001 DOR)
- Crystal Light Chrome A HF (001 LTCH)
- Crystal Metallic Blue A HF (001 METBL)
- Crystal Metallic Light Gold A HF (001 MGLD)
- Crystal Metallic Sunshine A HF (001 METSH)
- Crystal Rainbow Dark A HF (001 RABDK)
- Crystal Rose Gold A HF (001 ROGL)
- Crystal Scarabæus Green***A HF (001 SCGR)

Crystal Lacquer^{PRO} Effects

Crystal Shiny Lacquer^{PRO} Effects

- Crystal Azure Blue HFT (001 L112S)
- Crystal Buttercup HFT (001 L124S)
- Crystal Dark Grey HFT (001 L111S)
- Crystal Dark Red HFT (001 L108S)
- Crystal Ivory Cream HFT (001 L106S)
- Crystal Light Coral HFT (001 L116S)
- Crystal Lilac HFT (001 L126S)
- Crystal Lime HFT (001 L125S)
- Crystal Mint Green HFT (001 L115S)
- Crystal Peony Pink HFT (001 L113S)
- Crystal Royal Blue HFT (001 L110S)
- Crystal Royal Green HFT (001 L109S)
- Crystal Royal Red HFT (001 L107S)
- Crystal Summer Blue HFT (001 L114S)

Color Effects

Transparent Effects

- Black Diamond Shimmer A HF (215 SHIM)
- Blue Zircon Satin A HF (229 SAT)
- Blue Zircon Shimmer A HF (229 SHIM)
- Citrine Shimmer A HF (249 SHIM)
- Cobalt Shimmer A HF (369 SHIM)
- Crystal Shimmer A HF (001 SHIM)
- Erinite Shimmer A HF (360 SHIM)
- Fuchsia Shimmer A HF (502 SHIM)
- Hyacinth Shimmer A HF (236 SHIM)
- Jet AB A HF (280 AB)
- Jonquil AB A HF (213 AB)
- Light Colorado Topaz Shimmer A HF (246 SHIM)

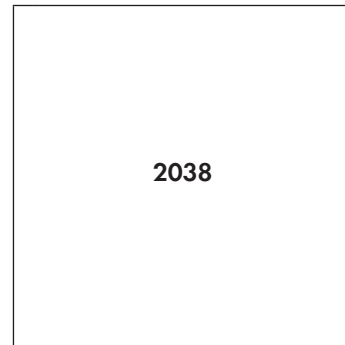

2038

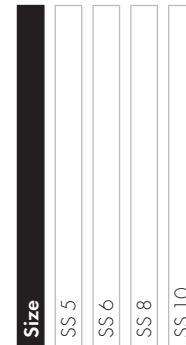

- Light Rose AB A HF (223 AB)
- Light Sapphire Shimmer A HF (211 SHIM)
- Light Siam AB A HF (227 AB)
- Light Siam Shimmer A HF (227 SHIM)
- Light Topaz Shimmer A HF (226 SHIM)
- Peridot Shimmer A HF (214 SHIM)
- Sapphire Satin A HF (206 SAT)
- Siam Shimmer A HF (208 SHIM)
- Silk Shimmer A HF (391 SHIM)
- Tangerine Shimmer A HF (259 SHIM)
- Topaz Shimmer A HF (203 SHIM)

Metallic Effects

- Jet Hematite A HF (280 HEM)
- Jet Nut A HF (280 NUT)

*** designed by Jean Paul Gaultier

2038/I Rimmed Flat Back

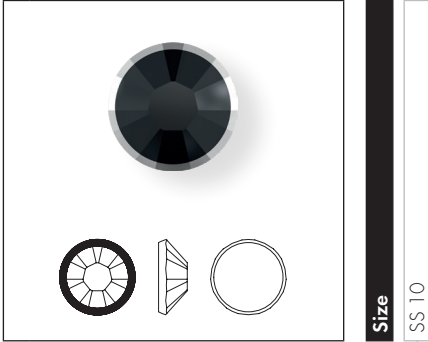

Size
SS 10

Crystal Effects

Metallic Effects

- Crystal & Dorado Z A HF (001 DORZ)
- Crystal & Lt. Chrome Z A HF (001 LTCHZ)

Color Effects

Metallic Effects

- Black Diamond & Dorado Z A HF (215 DORZ)
- Black Diamond & Lt. Chrome Z A HF (215 LTCHZ)
- Burgundy & Dorado Z A HF (515 DORZ)
- Burgundy & Lt. Chrome Z A HF (515 LTCHZ)
- Denim Blue & Dorado Z A HF (266 DORZ)
- Denim Blue & Lt. Chrome Z A HF (266 LTCHZ)
- Greige & Dorado Z A HF (284 DORZ)
- Greige & Lt. Chrome Z A HF (284 LTCHZ)
- Jet & Dorado Z A HF (280 DORZ)
- Jet & Lt. Chrome Z A HF (280 LTCHZ)
- Khaki & Dorado Z A HF (550 DORZ)
- Khaki & Lt. Chrome Z A HF (550 LTCHZ)
- Light Siam & Dorado Z A HF (227 DORZ)
- Light Siam & Lt. Chrome Z A HF (227 LTCHZ)
- White Opal & Dorado Z A HF (234 DORZ)
- White Opal & Lt. Chrome Z A HF (234 LTCHZ)

FLAT BACKS FOR TRANSFERS

CORE ASSORTMENT

2078 XIRIUS Rose Hoifix

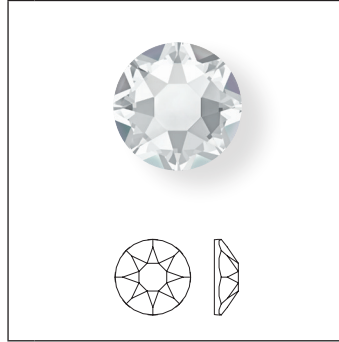

Size

SS 12
SS 16
SS 20
SS 30
SS 34
SS 40
SS 48

Crystal

- Crystal A HF (001)
- Crystal Hoifix Transparent (001 HFT)

Colors

Plain Colors

- Amethyst A HF (204)
- Aquamarine A HF (202)
- Black Diamond A HF (215)
- Blue Zircon A HF (229)
- Blush Rose A HF (257)
- Burgundy A HF (515)
- Capri Blue A HF (243)
- Chalkwhite A HF (279)
- Chrysolite A HF (238)
- Citrine A HF (249)
- Cobalt A HF (369)
- Dark Indigo A HF (288)
- Denim Blue A HF (266)
- Emerald A HF (205)
- Erinte A HF (360)
- Fern Green A HF (291)
- Fireopal A HF (237)
- Fuchsia A HF (502)
- Graphite A HF (253)
- Greige A HF (284)
- Hyacinth A HF (236)
- Indian Pink A HF (289)
- Indian Siam A HF (327)
- Jet A HF (280)
- Jonquil A HF (213)
- Khaki A HF (550)
- Light Amethyst A HF (212)
- Light Colorado Topaz A HF (246)
- Light Peach A HF (362)
- Light Rose A HF (223)
- Light Sapphire A HF (211)
- Light Siam A HF (227)
- Light Silk A HF (261)
- Light Topaz A HF (226)
- Light Turquoise A HF (263)

| | | | | | | | |
|--------------------------------------|---|---|---|---|---|---|---|
| Crystal A HF (001) | ◆ | ◆ | ◆ | ◆ | ◆ | ◆ | ◆ |
| Crystal Hoifix Transparent (001 HFT) | | ◆ | | | | | |
| Amethyst A HF (204) | ◆ | ◆ | ◆ | ◆ | ◆ | | |
| Aquamarine A HF (202) | ◆ | ◆ | ◆ | ◆ | ◆ | | |
| Black Diamond A HF (215) | ◆ | ◆ | ◆ | ◆ | ◆ | ◆ | ◆ |
| Blue Zircon A HF (229) | ◆ | ◆ | ◆ | ◆ | ◆ | | |
| Blush Rose A HF (257) | ◆ | ◆ | ◆ | ◆ | ◆ | | |
| Burgundy A HF (515) | ◆ | ◆ | ◆ | ◆ | ◆ | | |
| Capri Blue A HF (243) | ◆ | ◆ | ◆ | ◆ | ◆ | | |
| Chalkwhite A HF (279) | ◆ | ◆ | ◆ | ◆ | ◆ | | |
| Chrysolite A HF (238) | ◆ | ◆ | ◆ | ◆ | ◆ | | |
| Citrine A HF (249) | ◆ | ◆ | ◆ | ◆ | ◆ | | |
| Cobalt A HF (369) | ◆ | ◆ | ◆ | ◆ | ◆ | | |
| Dark Indigo A HF (288) | ◆ | ◆ | ◆ | ◆ | ◆ | | |
| Denim Blue A HF (266) | ◆ | ◆ | ◆ | ◆ | ◆ | | |
| Emerald A HF (205) | ◆ | ◆ | ◆ | ◆ | ◆ | | |
| Erinte A HF (360) | ◆ | ◆ | ◆ | ◆ | ◆ | | |
| Fern Green A HF (291) | ◆ | ◆ | ◆ | ◆ | ◆ | | |
| Fireopal A HF (237) | ◆ | ◆ | ◆ | ◆ | ◆ | | |
| Fuchsia A HF (502) | ◆ | ◆ | ◆ | ◆ | ◆ | | |
| Graphite A HF (253) | ◆ | ◆ | ◆ | ◆ | ◆ | | |
| Greige A HF (284) | ◆ | ◆ | ◆ | ◆ | ◆ | | |
| Hyacinth A HF (236) | ◆ | ◆ | ◆ | ◆ | ◆ | | |
| Indian Pink A HF (289) | ◆ | ◆ | ◆ | ◆ | ◆ | | |
| Indian Siam A HF (327) | ◆ | ◆ | ◆ | ◆ | ◆ | | |
| Jet A HF (280) | ◆ | ◆ | ◆ | ◆ | ◆ | | |
| Jonquil A HF (213) | ◆ | ◆ | ◆ | ◆ | ◆ | | |
| Khaki A HF (550) | ◆ | ◆ | ◆ | ◆ | ◆ | | |
| Light Amethyst A HF (212) | ◆ | ◆ | ◆ | ◆ | ◆ | | |
| Light Colorado Topaz A HF (246) | ◆ | ◆ | ◆ | ◆ | ◆ | | |
| Light Peach A HF (362) | ◆ | ◆ | ◆ | ◆ | ◆ | | |
| Light Rose A HF (223) | ◆ | ◆ | ◆ | ◆ | ◆ | | |
| Light Sapphire A HF (211) | ◆ | ◆ | ◆ | ◆ | ◆ | | |
| Light Siam A HF (227) | ◆ | ◆ | ◆ | ◆ | ◆ | | |
| Light Silk A HF (261) | ◆ | ◆ | ◆ | ◆ | ◆ | | |
| Light Topaz A HF (226) | ◆ | ◆ | ◆ | ◆ | ◆ | | |
| Light Turquoise A HF (263) | ◆ | ◆ | ◆ | ◆ | ◆ | | |

| 2078 | | Size | SS 12 | SS 16 | SS 20 | SS 30 | SS 34 | SS 40 | SS 48 |
|---|--|------|-------|-------|-------|-------|-------|-------|-------|
| ● Majestic Blue A HF (296) | | | ■ | ■ | ■ | | ■ | | |
| ● Montana A HF (207) | | | ■ | ■ | ■ | ■ | ■ | | |
| ● Olivine A HF (228) | | | ■ | ■ | ■ | | ■ | | |
| ● Padparadscha A HF (542) | | | ■ | ■ | ■ | | ■ | | |
| ● Peridot A HF (214) | | | ■ | ■ | ■ | | ■ | | |
| ● Provence Lavender A HF (283) | | | ■ | ■ | ■ | | ■ | | |
| ● Purple Velvet A HF (277) | | | ■ | ■ | ■ | | ■ | | |
| ● Rose A HF (209) | | | ■ | ■ | ■ | | ■ | | |
| ● Rose Peach A HF (262) | | | ■ | ■ | ■ | | ■ | | |
| ● Ruby A HF (501) | | | ■ | ■ | ■ | | ■ | | |
| ● Sapphire A HF (206) | | | ■ | ■ | ■ | | ■ | | |
| ● Scarlet A HF (276) | | | ◆ | ◆ | ◆ | ◆ | ◆ | | |
| ● Siam A HF (208) | | | ■ | ■ | ■ | | ■ | | |
| ● Silk A HF (391) | | | ■ | ■ | ■ | | ■ | | |
| ● Smoked Topaz A HF (220) | | | ■ | ■ | ■ | | ■ | | |
| ● Sunflower A HF (292) | | | ■ | ■ | ■ | | ■ | | |
| ● Tangerine A HF (259) | | | ■ | ■ | ■ | | ■ | | |
| ● Tanzanite A HF (539) | | | ■ | ■ | ■ | | ■ | | |
| ● Topaz A HF (203) | | | ■ | ■ | ■ | | ■ | | |
| ● Vintage Rose A HF (319) | | | ■ | ■ | ■ | | ■ | | |
| Opal Colors | | | | | | | | | |
| ● Light Grey Opal A HF (383) | | | ■ | ■ | ■ | | ■ | | |
| ● Pacific Opal A HF (390) | | | ■ | ■ | ■ | | ■ | | |
| ● White Opal A HF (234) | | | ■ | ■ | ■ | | ■ | | |
| ● Yellow Opal A HF (231) | | | ■ | ■ | ■ | | ■ | | |
| Crystal Effects | | | | | | | | | |
| Transparent Effects | | | | | | | | | |
| ● Crystal AB A HF (001 AB) | | | ■ | ■ | ■ | ■ | ■ | ■ | ■ |
| ● Crystal Blue Shade A HF (001 BLSH) | | | ■ | ■ | ■ | | ■ | | |
| ● Crystal Copper A HF (001 COP) | | | ■ | ■ | ■ | | ■ | | |
| ● Crystal Golden Shadow A HF (001 GSHA) | | | ■ | ■ | ■ | ■ | ■ | | |
| ● Crystal Luminous Green A HF (001 LUMG) | | | ■ | ■ | ■ | | ■ | | |
| ● Crystal Meridian Blue A HF (001 MBL) | | | ■ | ■ | ■ | | ■ | | |
| ● Crystal Moonlight A HF (001 MOL) | | | ■ | ■ | ■ | | ■ | | |
| ● Crystal Paradise Shine A HF (001 PARSH) | | | ■ | ■ | ■ | | ■ | | |
| ● Crystal Silver Night A HF (001 SINI) | | | ■ | ■ | ■ | | ■ | | |
| ● Crystal Silver Shade A HF (001 SSHA) | | | ■ | ■ | ■ | | ■ | | |
| ● Crystal Transmission HFT (001 TRA HFT) | | | ■ | ■ | ■ | | ■ | | |
| ● Crystal Volcano A HF (001 VOL) | | | ■ | ■ | ■ | | ■ | | |

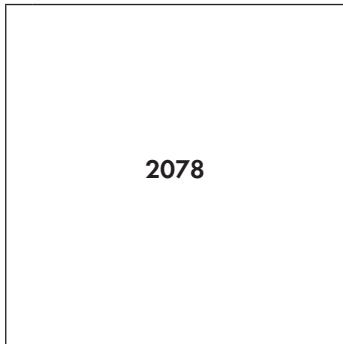

| Size | SS 12 | SS 16 | SS 20 | SS 30 | SS 34 | SS 40 | SS 48 |
|------|-------|-------|-------|-------|-------|-------|-------|
|------|-------|-------|-------|-------|-------|-------|-------|

Metallic Effects

- Crystal Dorado A HF (001 DOR)
- Crystal Light Chrome A HF (001 LTCH)
- Crystal Metallic Blue A HF (001 METBL)
- Crystal Metallic Light Gold A HF (001 MIGLD)
- Crystal Metallic Sunshine A HF (001 METSH)
- Crystal Rainbow Dark A HF (001 RABDK)
- Crystal Rose Gold A HF (001 ROGL)
- Crystal Scarabaeus Green***A HF (001 SCGR)

Crystal Lacquer^{PRO} Effects

Crystal Shiny Lacquer^{PRO} Effects

- Crystal Azure Blue HFT (001 L112S)
- Crystal Buttercup HFT (001 L124S)
- Crystal Dark Grey HFT (001 L111S)
- Crystal Dark Red HFT (001 L108S)
- Crystal Ivory Cream HFT (001 L106S)
- Crystal Lilac HFT (001 L126S)
- Crystal Lime HFT (001 L125S)
- Crystal Light Coral HFT (001 L116S)
- Crystal Mint Green HFT (001 L115S)
- Crystal Peony Pink HFT (001 L113S)
- Crystal Royal Blue HFT (001 L110S)
- Crystal Royal Green HFT (001 L109S)
- Crystal Royal Red HFT (001 L107S)
- Crystal Summer Blue HFT (001 L114S)

Color Effects

Transparent Effects

- Black Diamond Shimmer A HF (215 SHIM)
- Blue Zircon Satin A HF (229 SAT)
- Blue Zircon Shimmer A HF (229 SHIM)
- Citrine Shimmer A HF (249 SHIM)
- Cobalt Shimmer A HF (369 SHIM)
- Crystal Shimmer A HF (001 SHIM)
- Erinite Shimmer A HF (360 SHIM)
- Fuchsia Shimmer A HF (502 SHIM)
- Hyacinth Shimmer A HF (236 SHIM)
- Jet AB A HF (280 AB)
- Jonquil AB A HF (213 AB)
- Light Colorado Topaz Shimmer A HF (246 SHIM)

*** designed by Jean Paul Gaultier

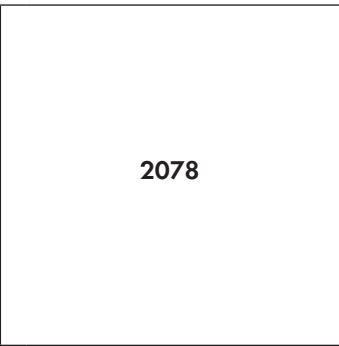

2078

| | Size | SS 12 | SS 16 | SS 20 | SS 30 | SS 34 | SS 40 | SS 48 | |
|--|------|-------|-------|-------|-------|-------|-------|-------|--|
| Light Rose AB A HF (223 AB) | | ■ | ■ | ■ | | ■ | | | |
| Light Sapphire Shimmer A HF (211 SHIM) | | | ■ | ■ | | ■ | | | |
| Light Siam AB A HF (227 AB) | | ■ | ■ | ■ | | ■ | | | |
| Light Siam Shimmer A HF (227 SHIM) | | | ■ | ■ | | ■ | | | |
| Light Topaz Shimmer A HF (226 SHIM) | | | ■ | ■ | | ■ | | | |
| Peridot Shimmer A HF (214 SHIM) | | | ■ | ■ | | ■ | | | |
| Sapphire Satin A HF (206 SAT) | | ■ | ■ | ■ | | ■ | | | |
| Siam Shimmer A HF (208 SHIM) | | | ■ | ■ | | ■ | | | |
| Silk Shimmer A HF (391 SHIM) | | | ■ | ■ | | ■ | | | |
| Tangerine Shimmer A HF (259 SHIM) | | | ■ | ■ | | ■ | | | |
| Topaz Shimmer A HF (203 SHIM) | | | ■ | ■ | | ■ | | | |
| Metallic Effects | | | | | | | | | |
| Jet Hematite A HF (280 HEM) | | ■ | ■ | ■ | ■ | ■ | | | |
| Jet Nut A HF (280 NUT) | | ■ | ■ | ■ | | ■ | | | |

2078/H Framed Flat Back¹



| Size & color of ring |
|----------------------|
| SS 16 Gold (GR) |
| SS 16 Silver (SR) |
| SS 16 Gun Metal (GM) |
| SS 20 Gold (GR) |
| SS 20 Silver (SR) |
| SS 20 Gun Metal (GM) |
| SS 34 Gold (GR) |
| SS 34 Silver (SR) |
| SS 34 Gun Metal (GM) |

Crystal

Crystal A HF (001)

Colors

Plain Colors

Black Diamond A HF (215)

Denim Blue A HF (266)

Jet A HF (280)

Light Colorado Topaz A HF (246)

Light Rose A HF (223)

Light Siam A HF (227)

Silk A HF (391)

Crystal Effects

Transparent Effects

Crystal AB A HF (001 AB)

Crystal Golden Shadow A HF (001 GSHA)

Crystal Silver Night A HF (001 SINI)

Crystal Silver Shade A HF (001 SSHA)

Metallic Effects

Crystal Light Chrome A HF (001 LTCH)

Crystal Scarabæus Green*** A HF (001 SCGR)

Color Effects

Transparent Effects

Jet Hematite A HF (280 HEM)

| | | | | | | | | | |
|--|-----------------|-------------------|----------------------|-----------------|-------------------|----------------------|-----------------|-------------------|----------------------|
| Crystal A HF (001) | SS 16 Gold (GR) | SS 16 Silver (SR) | SS 16 Gun Metal (GM) | SS 20 Gold (GR) | SS 20 Silver (SR) | SS 20 Gun Metal (GM) | SS 34 Gold (GR) | SS 34 Silver (SR) | SS 34 Gun Metal (GM) |
| Black Diamond A HF (215) | ■ | ■ | ■ | ■ | ■ | ■ | ■ | ■ | ■ |
| Denim Blue A HF (266) | ■ | ■ | ■ | ■ | ■ | ■ | ■ | ■ | ■ |
| Jet A HF (280) | ■ | ■ | ■ | ■ | ■ | ■ | ■ | ■ | ■ |
| Light Colorado Topaz A HF (246) | ■ | ■ | ■ | ■ | ■ | ■ | ■ | ■ | ■ |
| Light Rose A HF (223) | ■ | ■ | ■ | ■ | ■ | ■ | ■ | ■ | ■ |
| Light Siam A HF (227) | ■ | ■ | ■ | ■ | ■ | ■ | ■ | ■ | ■ |
| Silk A HF (391) | ■ | ■ | ■ | ■ | ■ | ■ | ■ | ■ | ■ |
| Crystal AB A HF (001 AB) | ■ | ■ | ■ | ■ | ■ | ■ | ■ | ■ | ■ |
| Crystal Golden Shadow A HF (001 GSHA) | ■ | ■ | ■ | ■ | ■ | ■ | ■ | ■ | ■ |
| Crystal Silver Night A HF (001 SINI) | ■ | ■ | ■ | ■ | ■ | ■ | ■ | ■ | ■ |
| Crystal Silver Shade A HF (001 SSHA) | ■ | ■ | ■ | ■ | ■ | ■ | ■ | ■ | ■ |
| Crystal Light Chrome A HF (001 LTCH) | ■ | ■ | ■ | ■ | ■ | ■ | ■ | ■ | ■ |
| Crystal Scarabæus Green*** A HF (001 SCGR) | ■ | ■ | ■ | ■ | ■ | ■ | ■ | ■ | ■ |
| Jet Hematite A HF (280 HEM) | ■ | ■ | ■ | ■ | ■ | ■ | ■ | ■ | ■ |

FLAT BACKS FOR TRANSFERS

*** designed by Jean Paul Gaultier

¹ General lead time: approx. 3 weeks

The lead time for sampling quantities of up to 2 packing units is approx. 3 weeks.

For special or rush orders, please get in touch with your customer service representative.

2078/I Rimmed Flat Back

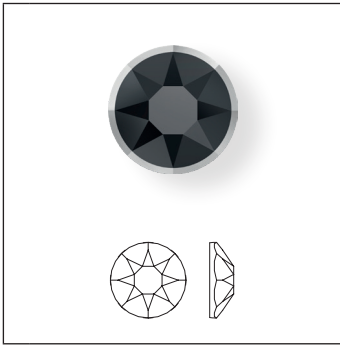

| Size | SS 16 | SS 20 | SS 34 |
|------|-------|-------|-------|
|------|-------|-------|-------|

- Crystal Effects**
- Metallic Effects**
- Crystal & Dorado Z AHF (001 DORZ)
- Crystal & Lt. Chrome Z A HF (001 LTCHZ)
- Color Effects**
- Metallic Effects**
- Black Diamond & Dorado Z A HF (215 DORZ)
- Black Diamond & Lt. Chrome Z A HF (215 LTCHZ)
- Burgundy & Dorado Z A HF (515 DORZ)
- Burgundy & Lt. Chrome Z A HF (515 LTCHZ)
- Denim Blue & Dorado Z A HF (266 DORZ)
- Denim Blue & Lt. Chrome Z A HF (266 LTCHZ)
- Greige & Dorado Z A HF (284 DORZ)
- Greige & Lt. Chrome Z A HF (284 LTCHZ)
- Jet & Dorado Z A HF (280 DORZ)
- Jet & Lt. Chrome Z A HF (280 LTCHZ)
- Khaki & Dorado Z A HF (550 DORZ)
- Khaki & Lt. Chrome Z A HF (550 LTCHZ)
- Light Siam & Dorado Z A HF (227 DORZ)
- Light Siam & Lt. Chrome Z A HF (227 LTCHZ)
- White Opal & Dorado Z A HF (234 DORZ)
- White Opal & Lt. Chrome Z A HF (234 LTCHZ)

2080/H Framed Cabochon

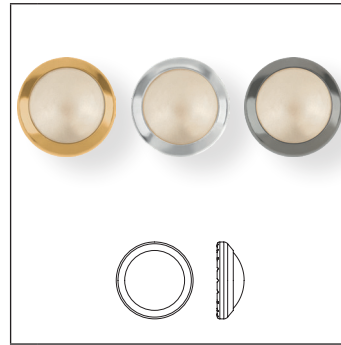

| Size & color of ring | SS 34 gold (GR) | SS 34 silver (SR) | SS 34 gun metal (GM) |
|----------------------|-----------------|-------------------|----------------------|
|----------------------|-----------------|-------------------|----------------------|

- Colors**
- Plain Colors**
- Jet M HF (280)
- Crystal Pearl Colors**
- Crystal Nacre HF (001 191)
- Crystal Cream Pearl HF (001 291)
- Crystal White Pearl HF (001 650)
- Crystal Effects**
- Transparent Effects**
- Crystal Golden Shadow HF (001 GSHA)
- Crystal Color Effects**
- Metallic Effects**
- Jet Hematite M HF (280 HEM)

CORE ASSORTMENT

2200 Navette Flat Back



Size
4x2 mm
8x4 mm

- Crystal**
- Crystal M HF (001) ◆
- Colors**
- Plain Colors**
- Amethyst M HF (204) ◆
- Aquamarine M HF (202) ◆
- Emerald M HF (205) ◆
- Jet M HF (280) ◆
- Light Colorado Topaz M HF (246) ◆
- Scarlet M HF (276) ◆
- Crystal Effects**
- Transparent Effects**
- Crystal AB M HF (001 AB) ■
- Crystal Golden Shadow M HF (001 GSHA) ■
- Crystal Silver Shade M HF (001 SSHA) ■
- Crystal Color Effects**
- Metallic Effects**
- Jet Hematite M HF (280 HEM) ■

2200/1 Rimmed Navette Flat Back

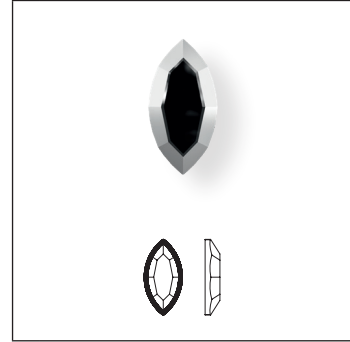

Size
8x4 mm

- Crystal Effects**
- Metallic Effects**
- Crystal & Dorado Z M HF (001 DORZ) ■
- Crystal & Lt. Chrome Z M HF (001 LTCHZ) ■
- Color Effects**
- Metallic Effects**
- Jet & Dorado Z M HF (280 DORZ) ■
- Jet & Lt. Chrome Z M HF (280 LTCHZ) ■

2201 Marquise Flat Back

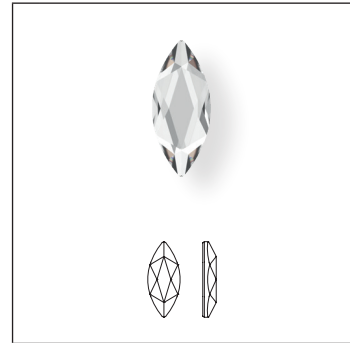

Size
8x3.5 mm
14x6 mm

- Crystal**
- Crystal M HF (001) ■
- Colors**
- Plain Colors**
- Aquamarine M HF (202) ■
- Emerald M HF (205) ■
- Graphite M HF (253) ■
- Jet M HF (280) ■
- Sapphire M HF (206) ■
- Scarlet M HF (276) ■
- Sunflower M HF (292) ■
- Vintage Rose M HF (319) ■
- Crystal Effects**
- Transparent Effects**
- Crystal AB M HF (001 AB) ■
- Crystal Golden Shadow M HF (001 GSHA) ■
- Crystal Silver Shade M HF (001 SSHA) ■

2205 Flame Flat Back

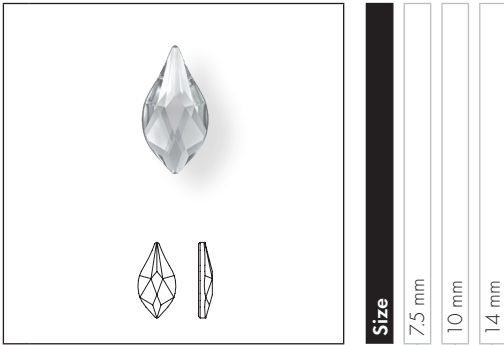

Size
7.5 mm
10 mm
14 mm

- Crystal**
- Crystal M HF (001)
- Colors**
- Plain Colors**
- Fireopal M HF (237)
- Jet M HF (280)
- Light Colorado Topaz M HF (246)
- Light Siam M HF (227)
- Opal Colors**
- White Opal M HF (234)
- Crystal Effects**
- Transparent Effects**
- Crystal AB M HF (001 AB)
- Crystal Golden Shadow M HF (001 GSHA)
- Crystal Silver Night M HF (001 SINI)
- Metallic Effects**
- Crystal Iridescent Green M HF (001 IRIG)

CORE ASSORTMENT

2300 Drop Flat Back

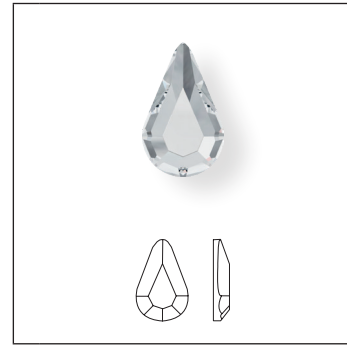

Size
8x4.8 mm

- Crystal**
- Crystal M HF (001)
- Colors**
- Plain Colors**
- Amethyst M HF (204)
- Aquamarine M HF (202)
- Emerald M HF (205)
- Jet M HF (280)
- Light Colorado Topaz M HF (246)
- Scarlet M HF (276)
- Crystal Effects**
- Transparent Effects**
- Crystal AB M HF (001 AB)
- Crystal Golden Shadow M HF (001 GSHA)
- Color Effects**
- Metallic Effects**
- Jet Hematite M HF (280 HEM)

2300/I Rimmed Drop Flat Back

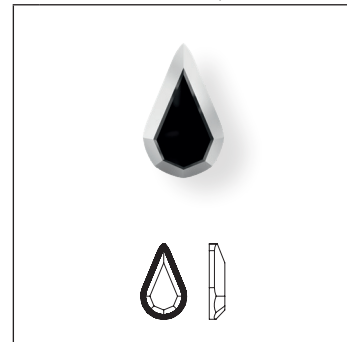

Size
8x4.8 mm

- Crystal Effects**
- Metallic Effects**
- Crystal & Dorado Z M HF (001 DORZ)
- Crystal & Lt. Chrome Z M HF (001 LTCHZ)
- Color Effects**
- Metallic Effects**
- Jet & Dorado Z M HF (280 DORZ)
- Jet & Lt. Chrome Z M HF (280 LTCHZ)

2303 Pear Flat Back

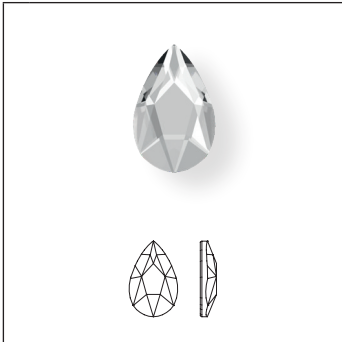

Size
8x5 mm
14x9 mm

Crystal

Crystal M HF (001)

Colors

Plain Colors

Aquamarine M HF (202)

Emerald M HF (205)

Graphite M HF (253)

Jet M HF (280)

Sapphire M HF (206)

Scarlet M HF (276)

Sunflower M HF (292)

Vintage Rose M HF (319)

Crystal Effects

Transparent Effects

Crystal AB M HF (001 AB)

Crystal Golden Shadow M HF (001 GSHA)

Crystal Silver Shade M HF (001 SSHA)

2304 Raindrop Flat Back

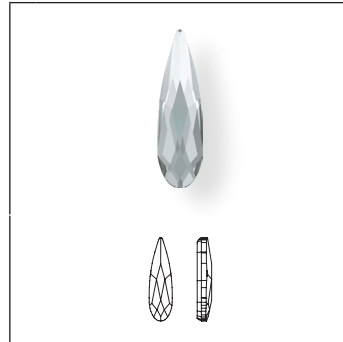

Size
10x2.8 mm

Crystal

Crystal M HF (001)

Colors

Plain Colors

Jet M HF (280)

Light Siam M HF (227)

Crystal Effects

Transparent Effects

Crystal AB M HF (001 AB)

Crystal Golden Shadow M HF (001 GSHA)

Crystal Luminous Green M HF (001 LUMG)

Crystal Silver Night M HF (001 SINI)

SQUARE FAMILY

CORE ASSORTMENT

2400 Square Flat Back

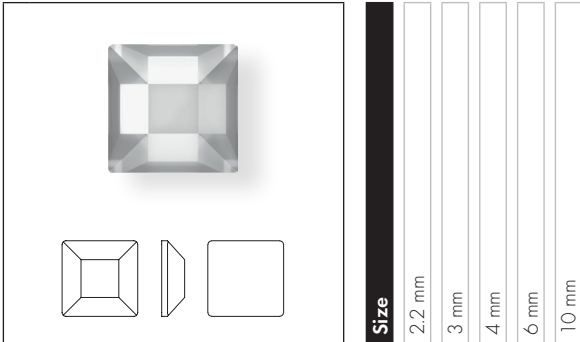

| | 2.2 mm | 3 mm | 4 mm | 6 mm | 10 mm |
|---------------------------------------|--------|------|------|------|-------|
| Crystal | | | | | |
| Crystal M HF (001) | ■ | ◆ | ◆ | ■ | ■ |
| Colors | | | | | |
| Plain Colors | | | | | |
| Amethyst M HF (204) | ■ | ◆ | ◆ | | |
| Aquamarine M HF (202) | ■ | ◆ | ◆ | | |
| Emerald M HF (205) | | ◆ | ◆ | | |
| Jet M HF (280) | ■ | ◆ | ◆ | ■ | ■ |
| Light Colorado Topaz M HF (246) | ■ | ◆ | ◆ | | |
| Scarlet M HF (276) | | ◆ | ◆ | | |
| Crystal Effects | | | | | |
| Transparent Effects | | | | | |
| Crystal AB M HF (001 AB) | ■ | ■ | ■ | ■ | |
| Crystal Golden Shadow M HF (001 GSHA) | ■ | ■ | ■ | ■ | |
| Crystal Silver Night M HF (001 SINI) | | | ■ | ■ | |
| Metallic Effects | | | | | |
| Crystal Dorado M HF (001 DOR) | | | ■ | ■ | |
| Crystal Light Chrome M HF (001 LTCH) | | ■ | ■ | ■ | |
| Color Effects | | | | | |
| Metallic Effects | | | | | |
| Jet Hematite M HF (280 HEM) | | ■ | ■ | ■ | |

2402 Base Flat Back

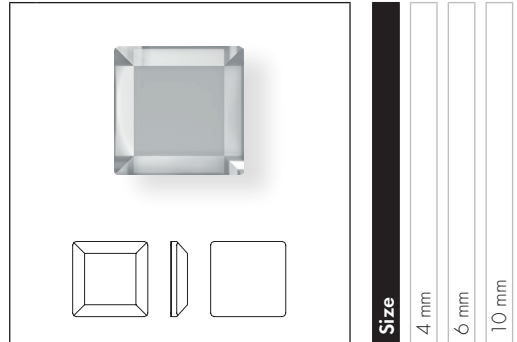

| | 4 mm | 6 mm | 10 mm |
|---------------------------------------|------|------|-------|
| Crystal | | | |
| Crystal M HF (001) | ■ | ■ | ■ |
| Colors | | | |
| Plain Colors | | | |
| Jet M HF (280) | ■ | ■ | ■ |
| Crystal Effects | | | |
| Transparent Effects | | | |
| Crystal AB M HF (001 AB) | ■ | ■ | |
| Crystal Golden Shadow M HF (001 GSHA) | ■ | ■ | |
| Crystal Silver Night M HF (001 SINI) | ■ | ■ | |
| Metallic Effects | | | |
| Crystal Dorado M HF (001 DOR) | ■ | ■ | |
| Crystal Light Chrome M HF (001 LTCH) | ■ | ■ | |
| Color Effects | | | |
| Metallic Effects | | | |
| Jet Hematite M HF (280 HEM) | ■ | ■ | |

2403 Pyramid Flat Back

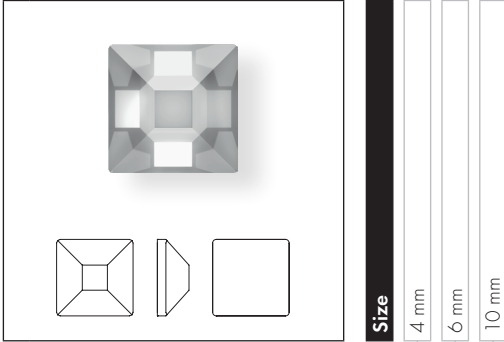

Size
4 mm
6 mm
10 mm

Crystal

Crystal M HF (001)

Colors

Plain Colors

Jet M HF (280)

Crystal Effects

Transparent Effects

Crystal AB M HF (001 AB)

Crystal Golden Shadow M HF (001 GSHA)

Crystal Silver Night M HF (001 SINI)

Metallic Effects

Crystal Dorado M HF (001 DOR)

Crystal Light Chrome M HF (001 LTCH)

Color Effects

Metallic Effects

Jet Hematite M HF (280 HEM)

2493 Chessboard Flat Back

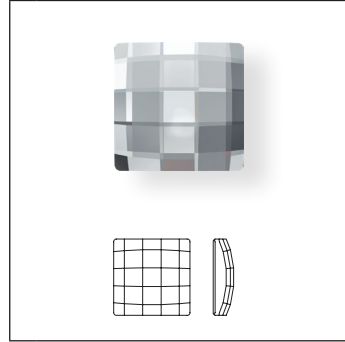

Size
8 mm
10 mm
12 mm

Crystal

Crystal M HF (001)

Crystal Effects

Crystal AB M HF (001 AB)

2494 Starlet Flat Back



Size
6 mm
8 mm
10.5 mm

Crystal

Crystal M HF (001)

Crystal Effects

Transparent Effects

Crystal Golden Shadow M HF (001 GSHA)

Crystal Paradise Shine M HF (001 PARSH)

2510 Baguette Flat Back

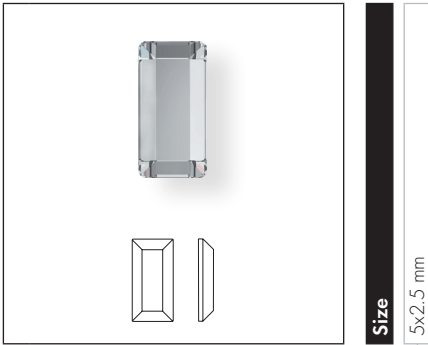

Size
5x2.5 mm

- Crystal**
- Crystal M HF (001)
- Colors**
- Plain Colors**
- Jet M HF (280)
- Crystal Effects**
- Transparent Effects**
- Crystal AB M HF (001 AB)
- Color Effects**
- Metallic Effects**
- Jet Hematite M HF (280 HEM)

2555 Cosmic Baguette Flat Back

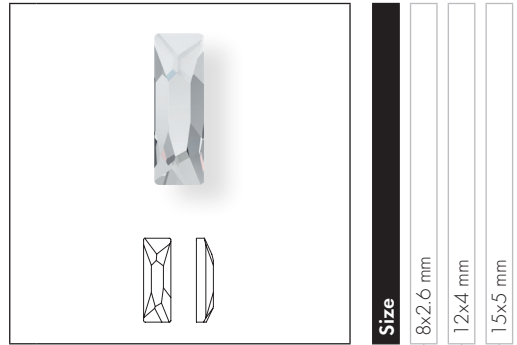

Size
8x2.6 mm
12x4 mm
15x5 mm

- Crystal**
- Crystal M HF (001)
- Crystal Effects**
- Transparent Effects**
- Crystal AB M HF (001 AB)
- Crystal Golden Shadow M HF (001 GSHA)
- Crystal Silver Shade M HF (001 SSHA)

2602 Emerald Cut Flat Back

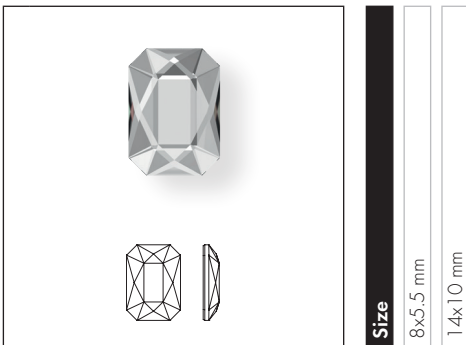

Size
8x5.5 mm
14x10 mm

- Crystal**
- Crystal M HF (001)
- Colors**
- Plain Colors**
- Aquamarine M HF (202)
- Emerald M HF (205)
- Graphite M HF (253)
- Jet M HF (280)
- Sapphire M HF (206)
- Scarlet M HF (276)
- Sunflower M HF (292)
- Vintage Rose M HF (319)
- Crystal Effects**
- Transparent Effects**
- Crystal AB M HF (001 AB)
- Crystal Golden Shadow M HF (001 GSHA)
- Crystal Silver Shade M HF (001 SSHA)

2610 Rectangle Flat Back

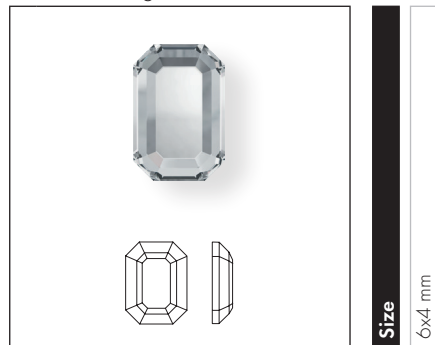

Size
6x4 mm

- Crystal**
- Crystal M HF (001)

2711 Triangle Flat Back



Size
3.3 mm
6 mm

Crystal

Crystal M HF (001)

Colors

Plain Colors

Amethyst M HF (204)

Aquamarine M HF (202)

Emerald M HF (205)

Jet M HF (280)

Light Colorado Topaz M HF (246)

Scarlet M HF (276)

Crystal Effects

Transparent Effects

Crystal AB M HF (001 AB)

Crystal Golden Shadow M HF (001 GSHA)

Color Effects

Metallic Effects

Jet Hematite M HF (280 HEM)

2711/I Rimmed Triangle Flat Back

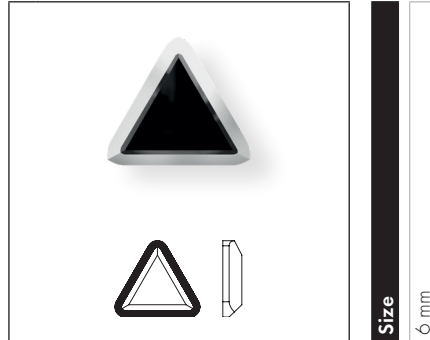

Size
6 mm

Crystal Effects

Metallic Effects

Crystal & Dorado Z M HF (001 DORZ)

Crystal & Lt. Chrome Z M HF (001 LTCHZ)

Color Effects

Metallic Effects

Jet & Dorado Z M HF (280 DORZ)

Jet & Lt. Chrome Z M HF (280 LTCHZ)

2714 Fan Flat Back Hoifix

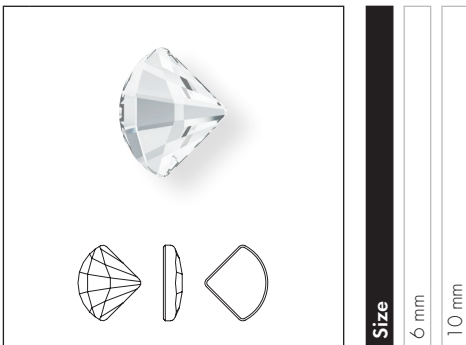

Size
6 mm
10 mm

Crystal

Crystal M HF (001)

Crystal Effects

Transparent Effects

Crystal AB M HF (001 AB)

2728 Marguerite Flat Back

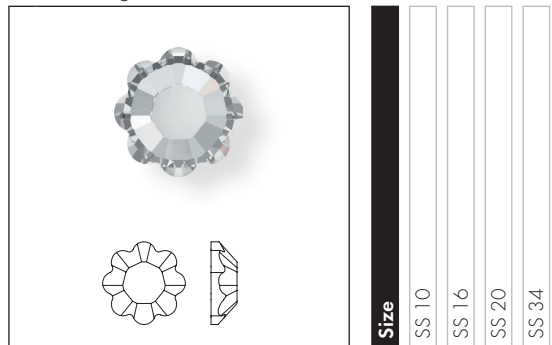

Size
SS 10
SS 16
SS 20
SS 34

Crystal

Crystal M HF (001)

Crystal Effects

Transparent Effects

Crystal AB M HF (001 AB)

TRIANGLE FAMILY

2738 Triangle Alpha Flat Back

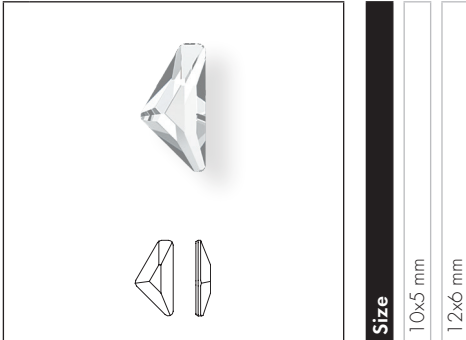

Size

10x5 mm

12x6 mm

Crystal

Crystal M HF (001)

Colors

Plain Colors

Blush Rose M HF (257)

Jet M HF (280)

Light Colorado Topaz M HF (246)

Light Sapphire M HF (211)

Light Siam M HF (227)

Crystal Effects

Transparent Effects

Crystal AB M HF (001 AB)

Crystal Golden Shadow M HF (001 GSHA)

Crystal Silver Night M HF (001 SINI)

Crystal Lacquer^{PRO} Effects

Crystal Shiny Lacquer^{PRO} Effects

Crystal Dark Grey HFT (001 L111S)

Crystal Dark Red HFT (001 L108S)

Crystal Ivory Cream HFT (001 L106S)

2739 Triangle Beta Flat Back

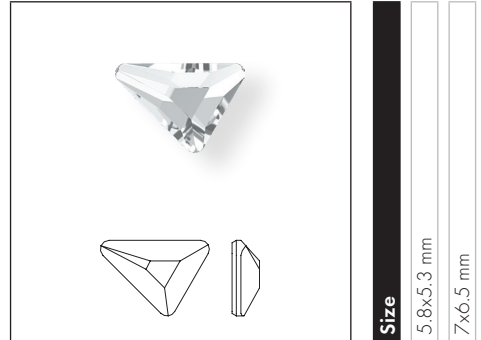

Size

5.8x5.3 mm

7x6.5 mm

Crystal

Crystal M HF (001)

Colors

Plain Colors

Blush Rose M HF (257)

Jet M HF (280)

Light Colorado Topaz M HF (246)

Light Sapphire M HF (211)

Light Siam M HF (227)

Crystal Effects

Transparent Effects

Crystal AB M HF (001 AB)

Crystal Golden Shadow M HF (001 GSHA)

Crystal Silver Night M HF (001 SINI)

Crystal Lacquer^{PRO} Effects

Crystal Shiny Lacquer^{PRO} Effects

Crystal Dark Grey HFT (001 L111S)

Crystal Dark Red HFT (001 L108S)

Crystal Ivory Cream HFT (001 L106S)

2740 Triangle Gamma Flat Back

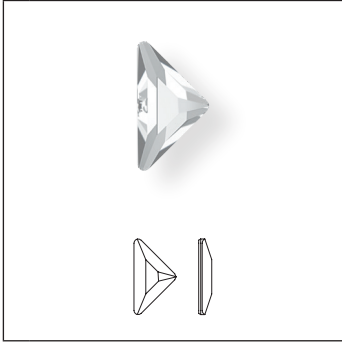

| | | |
|-------------|------------|----------|
| Size | 8.3x8.3 mm | 10x10 mm |
|-------------|------------|----------|

Crystal

Crystal M HF (001)

Colors

Plain Colors

Blush Rose M HF (257)

Jet M HF (280)

Light Colorado Topaz M HF (246)

Light Sapphire M HF (211)

Light Siam M HF (227)

Crystal Effects

Transparent Effects

Crystal AB M HF (001 AB)

Crystal Golden Shadow M HF (001 GSHA)

Crystal Silver Night M HF (001 SINI)

Crystal Lacquer^{PRO} Effects

Crystal Shiny Lacquer^{PRO} Effects

Crystal Dark Grey HFT (001 L111S)

Crystal Dark Red HFT (001 L108S)

Crystal Ivory Cream HFT (001 L106S)

FLAT BACKS FOR TRANSFERS

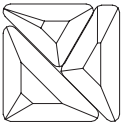

When Alpha, Beta, and Gamma Flat Backs are arranged together, they form a square.

2753¹ Edelweiss Flat Back

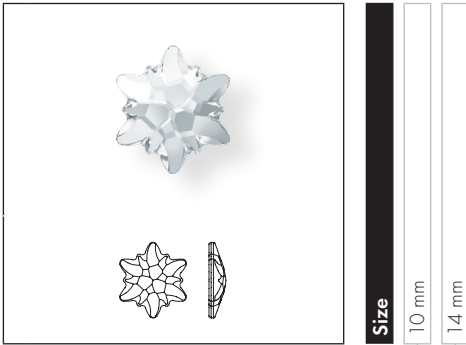

Size
10 mm
14 mm

- Crystal**
- Crystal M HF (001)
- Crystal Effects**
- Transparent Effects**
- Crystal AB M HF (001 AB)

2770 Wing Flat Back

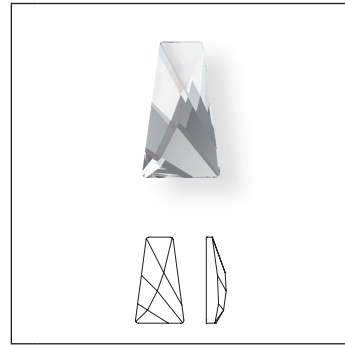

Size
6x3.5 mm

- Crystal**
- Crystal M HF (001)
- Crystal Effects**
- Transparent Effects**
- Crystal AB M HF (001 AB)

¹ Article 2753 is not available for Transfers Unlimited

GEOMETRIC FLAT BACKS

2771 Kite Flat Back Hoflix

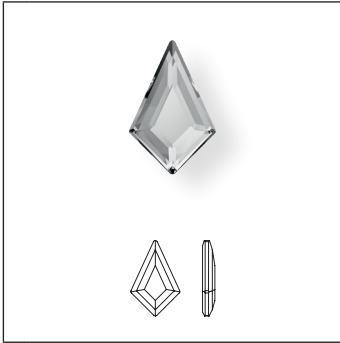

| Size |
|-------------|
| 6.4x4.2 mm |
| 8.6x5.6 mm |
| 12.9x8.3 mm |

| Crystal |
|---------------------------------------|
| Crystal M HF (001) |
| Colors |
| Plain Colors |
| Aquamarine M HF (202) |
| Black Diamond M HF (215) |
| Jet M HF (280) |
| Light Rose M HF (223) |
| Light Siam M HF (227) |
| Crystal Effects |
| Transparent Effects |
| Crystal AB M HF (001 AB) |
| Crystal Golden Shadow M HF (001 GSHA) |
| Crystal Silver Shade M HF (001 SSHA) |
| Color Effects |
| Metallic Effects |
| Jet Hematite M HF (280 HEM) |

2772 Trapeze Flat Back Hoflix

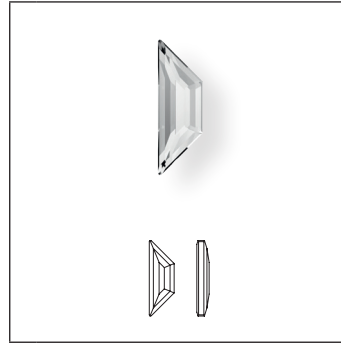

| Size |
|-------------|
| 6.5x2.1 mm |
| 8.6x2.8 mm |
| 12.9x4.2 mm |

| Crystal |
|---------------------------------------|
| Crystal M HF (001) |
| Colors |
| Plain Colors |
| Aquamarine M HF (202) |
| Black Diamond M HF (215) |
| Jet M HF (280) |
| Crystal Effects |
| Transparent Effects |
| Crystal AB M HF (001 AB) |
| Crystal Golden Shadow M HF (001 GSHA) |
| Crystal Silver Shade M HF (001 SSHA) |
| Color Effects |
| Metallic Effects |
| Jet Hematite M HF (280 HEM) |

2773 Diamond Shape Flat Back Hotfix

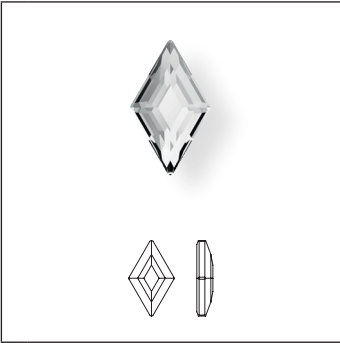

| Size |
|------------|
| 5x3 mm |
| 6.6x3.9 mm |
| 9.9x5.9 mm |

Crystal

Crystal M HF (001)

Colors

Plain Colors

Aquamarine M HF (202)

Black Diamond M HF (215)

Jet M HF (280)

Light Rose M HF (223)

Light Siam M HF (227)

Crystal Effects

Transparent Effects

Crystal AB M HF (001 AB)

Crystal Golden Shadow M HF (001 GSHA)

Crystal Silver Shade M HF (001 SSHA)

Color Effects

Metallic Effects

Jet Hematite M HF (280 HEM)

| | | | |
|---------------------------------------|---|---|---|
| Crystal M HF (001) | ■ | ■ | ■ |
| Aquamarine M HF (202) | ■ | ■ | ■ |
| Black Diamond M HF (215) | ■ | ■ | ■ |
| Jet M HF (280) | ■ | ■ | ■ |
| Light Rose M HF (223) | ■ | ■ | ■ |
| Light Siam M HF (227) | ■ | ■ | ■ |
| Crystal AB M HF (001 AB) | ■ | ■ | ■ |
| Crystal Golden Shadow M HF (001 GSHA) | ■ | ■ | ■ |
| Crystal Silver Shade M HF (001 SSHA) | ■ | ■ | ■ |
| Jet Hematite M HF (280 HEM) | ■ | ■ | ■ |

2788 Wave Flat Back

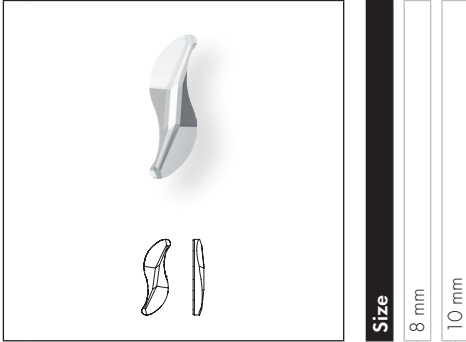

Size
8 mm
10 mm

- Crystal**
- Crystal M HF (001)
- Crystal Effects**
- Transparent Effects**
- Crystal AB M HF (001 AB)

2808 Heart Flat Back

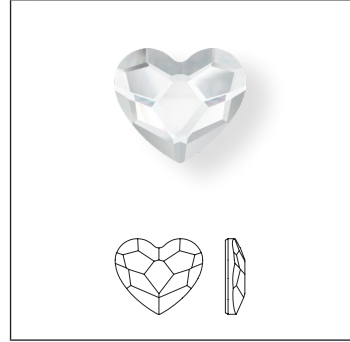

Size
6 mm
10 mm

- Crystal**
- Crystal M HF (001)
- Colors**
- Plain Colors**
- Fuchsia M HF (502)
- Light Siam M HF (227)
- Crystal Effects**
- Transparent Effects**
- Crystal AB M HF (001 AB)

2813 Moon Flat Back Hofix

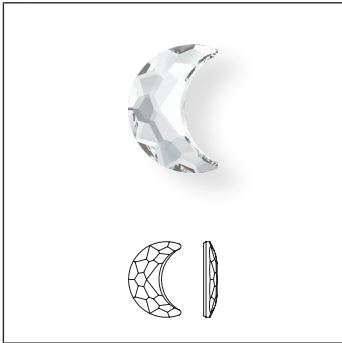

Size
8x5.5 mm

- Crystal**
- Crystal M HF (001)
- Crystal Effects**
- Transparent Effects**
- Crystal AB M HF (001 AB)

2817 Star Flat Back

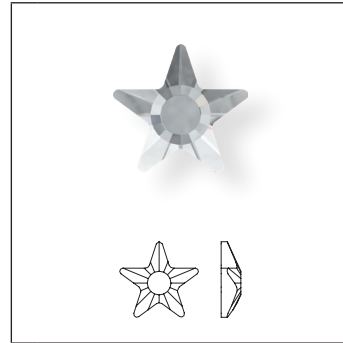

Size
5 mm

- Crystal**
- Crystal M HF (001)
- Crystal Effects**
- Transparent Effects**
- Crystal AB M HF (001 AB)

2855 Butterfly Flat Back

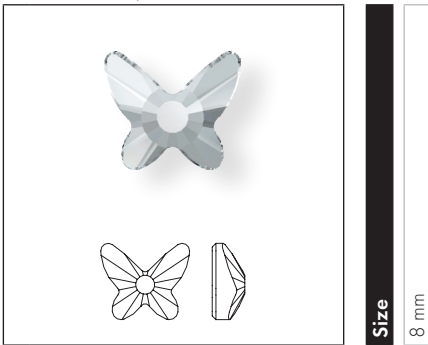

Size
8 mm

- Crystal**
- Crystal M HF (001)
- Crystal Effects**
- Transparent Effects**
- Crystal AB M HF (001 AB)

2856 Skull Flat Back

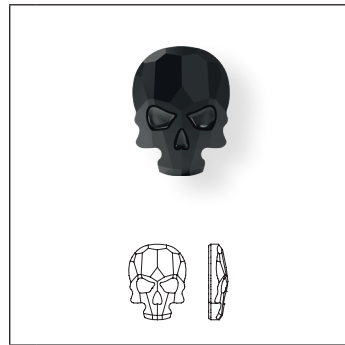

Size
10x7.5 mm
14x10.5 mm*
18x14 mm*

- Colors**
- Plain Colors**
- Jet M HF (280)
- Crystal Effects**
- Transparent Effects**
- Crystal AB M HF (001 AB)
- Crystal Golden Shadow M HF (001 GSHA)
- Crystal Silver Night M HF (001 SINI)
- Metallic Effects**
- Crystal Metallic Blue M HF (001 METBL)
- Crystal Metallic Light Gold M HF (001 MLGLD)
- Crystal Light Chrome M HF (001 LTCH)
- Color Effects**
- Metallic Effects**
- Jet Hematite M HF (280 HEM)

2858 Bow Tie Flat Back

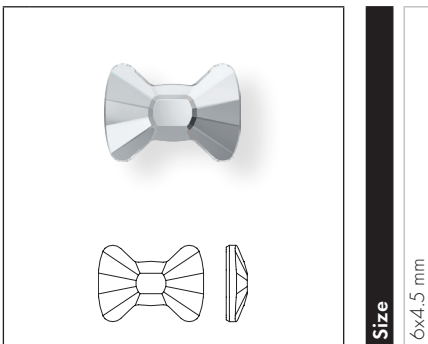

Size
6x4.5 mm

- Crystal**
- Crystal M HF (001)
- Crystal Effects**
- Transparent Effects**
- Crystal AB M HF (001 AB)

* not available for Transfers Unlimited

CABOCHONS

2080/4 Cabochon

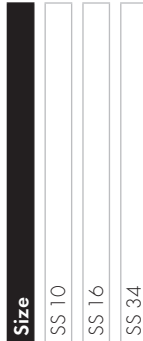
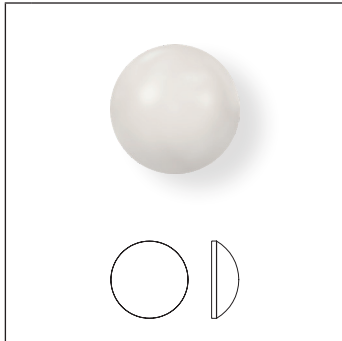

| Colors | | |
|---|---|---|
| Plain Colors | | |
| ● Jet M HF (280) | ■ | ■ |
| Crystal Pearl Colors | | |
| ● Crystal Bronze Pearl HF (001 295) | ■ | ■ |
| ● Crystal Nacre HF (001 191) | ■ | ■ |
| ● Crystal Creampearl HF (001 291) | ■ | ■ |
| ● Crystal Dark Grey Pearl HF (001 617) | ■ | ■ |
| ● Crystal Iridescent Dove Grey Pearl HF (001 954) | ■ | ■ |
| ● Crystal Light Grey Pearl HF (001 616) | ■ | ■ |
| ● Crystal Rose Gold Pearl HF (001 769) | ■ | ■ |
| ● Crystal Rosaline Pearl HF (001 294) | ■ | ■ |
| ● Crystal Vintage Gold Pearl HF (001 651) | ■ | ■ |
| ● Crystal White Pearl HF (001 650) | ■ | ■ |
| Crystal Effects | | |
| Transparent Effects | | |
| ● Crystal Golden Shadow HF (001 GSHA) | ■ | ■ |
| Metallic Effects | | |
| ● Crystal Light Chrome HF (001 LTCH) | ■ | ■ |
| ● Crystal Scarabaeus Green***HF (001 SCGR) | ■ | ■ |
| Crystal Color Effects | | |
| Metallic Effects | | |
| ● Jet Hematite M HF (280 HEM) | ■ | ■ |

2081/2 Cabochon Pearl

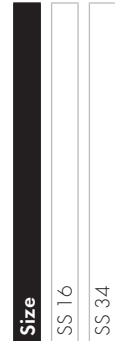
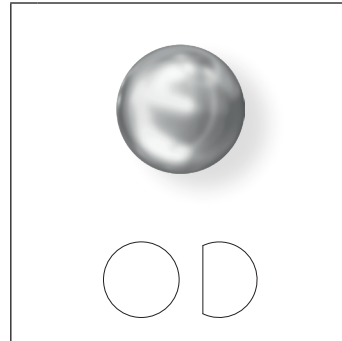

| Colors | | |
|---|---|---|
| Plain Colors | | |
| ● Jet G_PRHF (280) | ■ | ■ |
| Crystal Pearl Colors | | |
| ● Crystal Creampearl W_PRHF (001 291) | ■ | ■ |
| ● Crystal Iridescent Dove Grey Pearl W_PRHF (001 954) | ■ | ■ |
| ● Crystal Nacre W_PRHF (001 191) | ■ | ■ |
| ● Crystal Rose Gold Pearl W_PRHF (001 769) | ■ | ■ |
| ● Crystal Vintage Gold Pearl W_PRHF (001 651) | ■ | ■ |
| ● Crystal White Pearl W_PRHF (001 650) | ■ | ■ |
| Crystal Effects | | |
| Metallic Effects | | |
| ● Crystal Light Chrome G_PRHF (001 LTCH) | ■ | ■ |
| Crystal Color Effects | | |
| Metallic Effects | | |
| ● Jet Hematite M G_PRHF (280 HEM) | ■ | ■ |

CABOCHONS

2208/4 Cabochon Navette

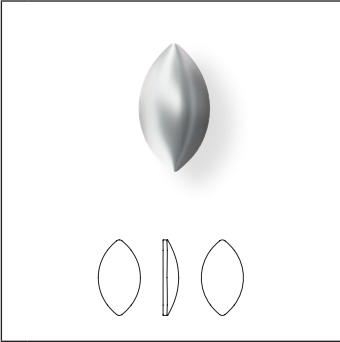

| | | | |
|-------------|----------|----------|-----------|
| Size | | | |
| | 6x3.5 mm | 8x4.5 mm | 10x5.5 mm |

Colors

Plain Colors

● Jet G_PRHF (280)

Crystal Pearl Colors

● Crystal Creampearl W_PRHF (001 291)

● Crystal Nacre W_PRHF (001 191)

● Crystal White Pearl W_PRHF (001 650)

Crystal Color Effects

Metallic Effects

● Jet Hematite G_PRHF (280 HEM)

| | | | |
|--|---|---|---|
| | ■ | ■ | ■ |
| | ■ | ■ | ■ |
| | ■ | ■ | ■ |
| | ■ | ■ | ■ |
| | ■ | ■ | ■ |
| | ■ | ■ | ■ |

2308/4 Cabochon Drop

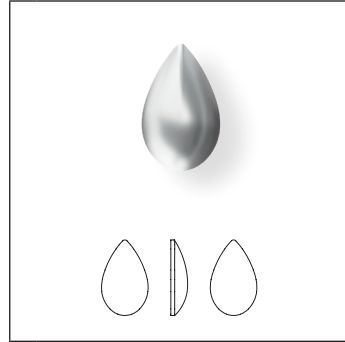

| | | | |
|-------------|----------|--------|---------|
| Size | | | |
| | 6x3.5 mm | 8x5 mm | 10x6 mm |

Colors

Plain Colors

● Jet G_PRHF (280)

Crystal Pearl Colors

● Crystal Creampearl W_PRHF (001 291)

● Crystal Nacre W_PRHF (001 191)

● Crystal White Pearl W_PRHF (001 650)

Crystal Color Effects

Metallic Effects

● Jet Hematite G_PRHF (280 HEM)

| | | | |
|--|---|---|---|
| | ■ | ■ | ■ |
| | ■ | ■ | ■ |
| | ■ | ■ | ■ |
| | ■ | ■ | ■ |
| | ■ | ■ | ■ |
| | ■ | ■ | ■ |

2408/4 Cabochon Square

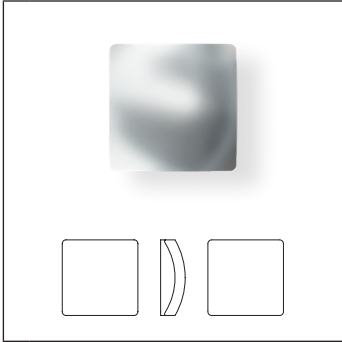

| Size |
|------|
| 4 mm |
| 6 mm |
| 8 mm |

Colors

Plain Colors

● Jet G_PRHF (280)

Crystal Pearl Colors

● Crystal Creampearl W_PRHF (001 291)

● Crystal Nacre W_PRHF (001 191)

● Crystal White Pearl W_PRHF (001 650)

Crystal Color Effects

Metallic Effects

● Jet Hematite G_PRHF (280 HEM)

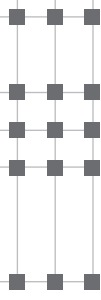

CRYSTAL DIAMONDS

1360 (with art. 1028 XILION Chaton)

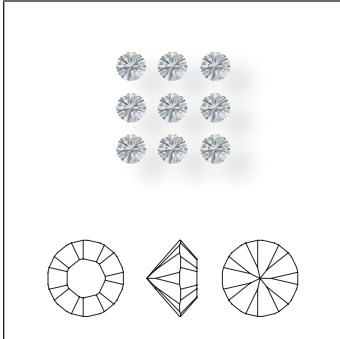



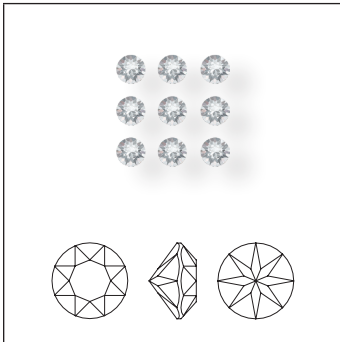























1360 (with art. 1088 XIRIUS Chaton)



| | | | | |
|---|-------------|---|---|---|
| 1360 ¹ | Size | PP 7 (PP7 with art. 1028 XILION Chaton) | PP 12 (PP12 with art. 1028 XILION Chaton) | PP 17 (PP17 with art. 1088 XIRIUS Chaton) |
| Crystal | | | | |
| <input type="checkbox"/> Crystal (001) | | <input type="checkbox"/> | <input type="checkbox"/> | <input type="checkbox"/> |
| Colors | | | | |
| Plain Colors | | | | |
| <input type="checkbox"/> Black Diamond (215) | | <input type="checkbox"/> | <input type="checkbox"/> | <input type="checkbox"/> |
| <input type="checkbox"/> Jet (280) | | <input type="checkbox"/> | <input type="checkbox"/> | <input type="checkbox"/> |
| <input type="checkbox"/> Light Colorado Topaz (246) | | <input type="checkbox"/> | <input type="checkbox"/> | <input type="checkbox"/> |
| <input type="checkbox"/> Light Rose (223) | | <input type="checkbox"/> | <input type="checkbox"/> | <input type="checkbox"/> |
| <input type="checkbox"/> Light Siam (227) | | <input type="checkbox"/> | <input type="checkbox"/> | <input type="checkbox"/> |
| <input type="checkbox"/> Rose (209) | | <input type="checkbox"/> | <input type="checkbox"/> | <input type="checkbox"/> |
| <input type="checkbox"/> Sapphire (206) | | <input type="checkbox"/> | <input type="checkbox"/> | <input type="checkbox"/> |
| Crystal Effects | | | | |
| Transparent Effects | | | | |
| <input type="checkbox"/> Crystal AB (001 AB) | | <input type="checkbox"/> | <input type="checkbox"/> | <input type="checkbox"/> |

¹ The article is only available within a Transfer, not as a loose stone

METALLICS

| | | | | | |
|---|-------------------------------------|---|----------------------------|---|--------------------------------|
|  | 3490 3490/006 (M2) |  | 3490 3490/008 (M8) |  | 3490 3490/002 (M10x3) |
|  | 3490 3490/012 (M2.5) |  | 3490 3490/009 (MZ8) |  | 3490 3490/010 (M7x3) |
|  | 3490 3490/300 (M3) |  | 3490 3490/007 (M10) |  | 3490 3490/003 (MST) |
|  | 3490 3490/400 (M4) |  | 3490 3490/001 (M7x7) |  | 3490 3490/005 (M12x6) |
|  | 3490 3490/600 (M6) |  | 3490 3490/011 (M3x3) |  | 3490 3490/013 (M9x4) |
|  | Gold ¹ brushed (081) |  | Silver brushed (082) |  | Gun metal brushed (086) |
|  | Gold ¹ polished (091) |  | Silver polished (092) |  | Gun metal polished (096) |
|  | Bronze brushed (084) |  | Copper brushed (080) |  | Black polished (070) |
|  | Bronze polished (094) |  | Copper polished (090) |  | Blue brushed (071) |

METALLICS

¹ Golden colored

² Color tones according to RAL colors.



Signal White
(R 9003²)



Traffic Red
(R 3020²)



Azure Blue
(R 5009²)



Grey Beige
(R 1019²)



Blue Lilac
(R 4005²)



Jet Black
(R 9005²)



Water Blue
(R 5021²)



Red Brown
(R 8012²)



Sapphire
(R 5003²)



Fern Green
(R 6025²)



Dark Purple
(R 4007²)



Zinc Yellow
(R 1018²)



Pastel Orange
(R 2003²)



Signal Green
(R 6032²)



Yellow Green
(R 6018²)



Telegrey
(R 7045²)

¹ Golden colored

² Color tones according to RAL colors.

TRANSFERS

ARTICLE EXPLANATION

12 906

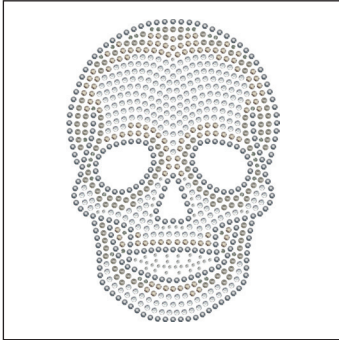

C 001/215/001/280HEM/
001SSHA/215
E S3/S3/S6/S6/S6/S6
S ~71x100
M 12 PCS **40%**

13 033

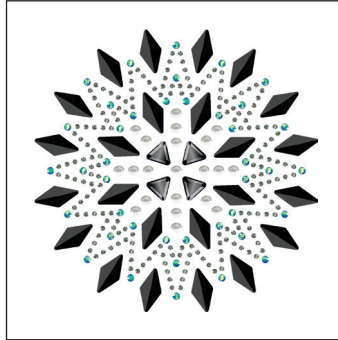

C 070-001LTCH/280HEM/215/
001IRIG
E M12x6-P3/CS7x6/S3/S6
S ~74x74
M 12 PCS **50%**

| 12 906 | C | E | S | M | 40% |
|--------|---|---|---|---|-----|
|--------|---|---|---|---|-----|

| Article number | Color assortment | Elements | Motif size in mm | Minimum order quantity in pieces (PCS) | % of actual size |
|----------------|---|--|------------------|--|------------------|
| | For further details, please refer to the color and product charts at the beginning of this chapter. Color code 1 (001) corresponds to element 1 (S3); color code 2 (215) corresponds to element 2 (S3) etc. | For details of stone sizes and element codes, please refer to the color and product charts at the beginning of this chapter. | | | |

| 13 033 | C | E | S | M | 50% |
|--------|---|---|---|---|-----|
|--------|---|---|---|---|-----|

| Article number | Color assortment | Elements | Motif size in mm | Minimum order quantity in pieces (PCS) | % of actual size |
|----------------|---|--|------------------|--|------------------|
| | For further details, please refer to the color and product charts at the beginning of this chapter. Color code 1 (070-001LTCH) corresponds to element 1 (M12x6-P3); color code 2 (280HEM) corresponds to element 2 (CS7x6) etc. Metallics are separated from crystal colors with hyphens. | For details of stone sizes and element codes, please refer to the color and product charts at the beginning of this chapter. Codes for Metallics are separated from crystal colors with hyphens. | | | |

ORDERING EXAMPLE & PRODUCT VARIETY EXPLANATION

| 13 033 | 070-001LTCH | 280HEM |
|----------------|--|---|
| Article number | Crystal color corresponding to element 1; color of the most frequently used element in the motif Please see the respective product charts at the beginning of this chapter for all available reference codes. | Crystal color corresponding to element 2; color of the second most frequently used element in the motif |

TRANSFERS UNLIMITED

With **Transfers Unlimited**, Swarovski presents a spectacular production technology that opens up an unprecedented range of motif designs. Up to 18 different elements - crystals, colors, sizes, and shapes - can be combined in a single motif, doubling design possibilities and offering stunning 3D surfaces, long rows, and even "floating" effects. With a tight compound that has

reduced the distance between elements to a minimum, **Transfers Unlimited** also offers the highest setting quality on the market.

The Flat Back assortment is the same as our existing standard transfers.

ARTICLE EXPLANATION

13 146

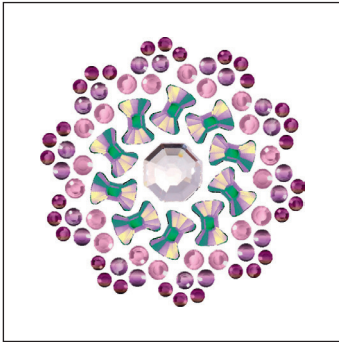

C 001/001PARSH/001LISH/
001ANTP/212

E 2611MM8/2858MM6x4.5/S6/
S8/S10

S ~35x36

M 55 PCS **100%**

13 147

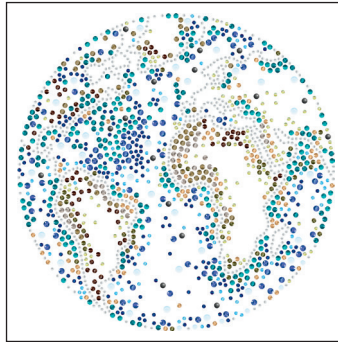

C 001617/001PBLUHFT/001PBLUHFT/
001/243/001LUMG/202/246/
220/550/263/229/263/
001MLGLD/284/206

E P3/P3/P4/S5/S6/S6/S6/S8/S8/
S8/S8/S10/S10/S10/S10/S12

S ~168x167

M 2 PCS **25%**

| 13 146 | C | E | S | M | 100% |
|----------------|---|--|------------------|--|------------------|
| Article number | Color assortment | Elements | Motif size in mm | Minimum order quantity in pieces (PCS) | % of actual size |
| | For further details, please refer to the color and product charts at the beginning of this chapter. Color code 1 (001) corresponds to element 1 (2611MM8); color code 2 (001 PARSH) corresponds to element 2 (2858MM6x4.5) etc. | For details of stone sizes and element codes, please refer to the color and product charts at the beginning of this chapter. | | | |

| 13 147 | C | E | S | M | 25% |
|----------------|---|--|------------------|--|------------------|
| Article number | Color assortment | Elements | Motif size in mm | Minimum order quantity in pieces (PCS) | % of actual size |
| | For further details, please refer to the color and product charts at the beginning of this chapter. Color code 1 (001617) corresponds to element 1 (P3); color code 2 (001PBLUHFT) corresponds to element 2 (P3) etc. Metallics are separated from crystal colors by hyphens. | For details of stone sizes and element codes, please refer to the color and product charts at the beginning of this chapter. Codes for Metallics are separated from crystal colors by hyphens. | | | |

ORDERING EXAMPLE & PRODUCT VARIETY EXPLANATION

| 13 146 | 001 | 001PARSH | 001LISH | 001ANTP | 212 |
|----------------|--|---|--|---|--|
| Article number | Crystal color corresponding to element 1; color of the most frequently used element in the motif | Crystal color corresponding to element 2; color of the second most frequently used element in the motif | Crystal color corresponding to element 3; color of the third most frequently used element in the motif | Crystal color corresponding to element 4; color of the fourth most frequently used element in the motif | Crystal color corresponding to element 5; color of the fifth most frequently used element in the motif |
| | Please see the respective product charts at the beginning of this chapter for all available reference codes. | | | | |

STANDARD COLLECTION

Transfers are available in a range of sizes and motifs to suit a variety of segments.

Numerous motifs and rows in all sizes and styles provide a creative pool of design ideas. The assortment is a balanced mix of large and small motifs in all price categories, as well as a good representation of all the different elements that can be used in Transfer motifs.

MOTIFS & ROWS

10 272

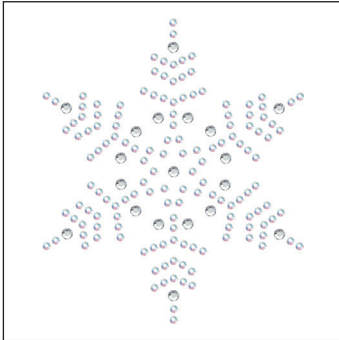

C 001AB/001
E S6/S10
S ~63x73
M 36 PCS **55%**

10 368

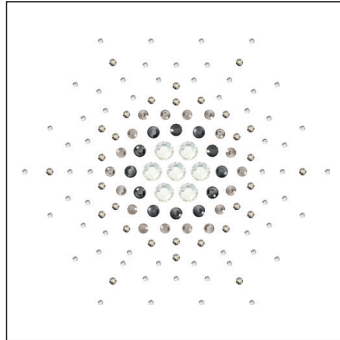

C 001/001SSHA/284/001SINI/
001MOL
E S6/S10/S16/S20/S34
S ~116x100
M 16 PCS **35%**

10 385

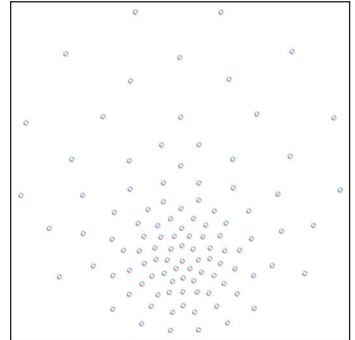

C 001AB
E S16
S ~230x230
M 4 PCS **19%**

10 402

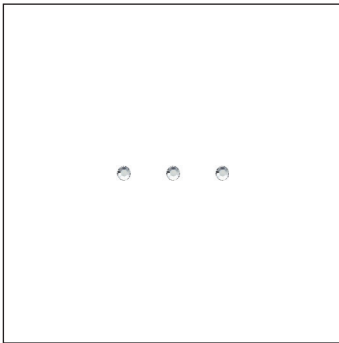

C 001
E S6
S ~982x2 (153 SEG/ROW)
M 18 ROWS **100%**

10 405

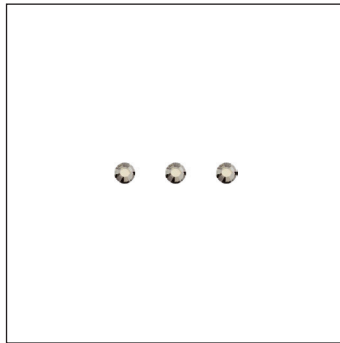

C 001SSHA
E S10
S ~984x3 (152 SEG/ROW)
M 16 ROWS **100%**

10 406

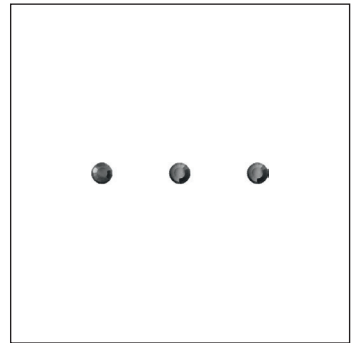

C 001SINI
E S10
S ~976x3 (99 SEG/ROW)
M 15 ROWS **100%**

10 408

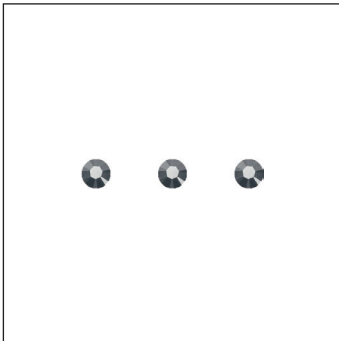

C 280HEM
E S16
S ~980x4 (98 SEG/ROW)
M 12 ROWS **100%**

10 412

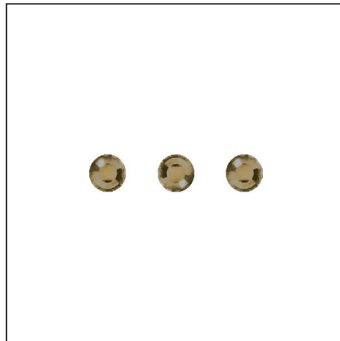

C 001MIGLD
E S20
S ~974x5 (116 SEG/ROW)
M 12 ROWS **100%**

10 413

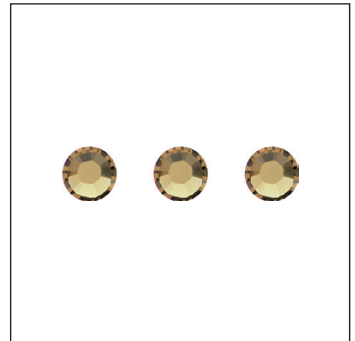

C 001GSHA
E S34
S ~979x7 (82 SEG/ROW)
M 9 ROWS **100%**

10 980

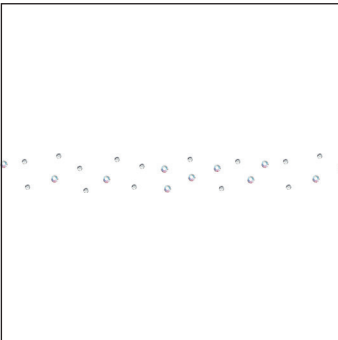

C 001/001AB
 E S6/S10
 S ~979x15 (10 SEG/ROW)
 M 10 ROWS **35%**

10 993

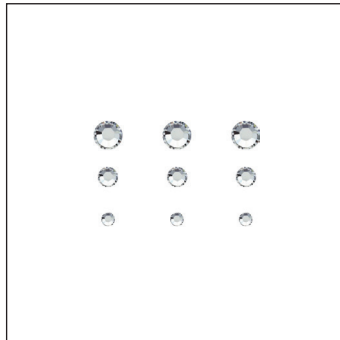

C 001/001/001
 E S6/S10/S16
 S ~980x14 (109 SEG/ROW)
 M 10 ROWS **100%**

11 094

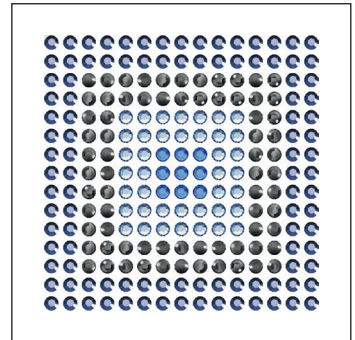

C 206SAT/001SINI/211/206
 E S10/S10/S10/S10
 S ~52x52
 M 48 PCS **70%**

11 167

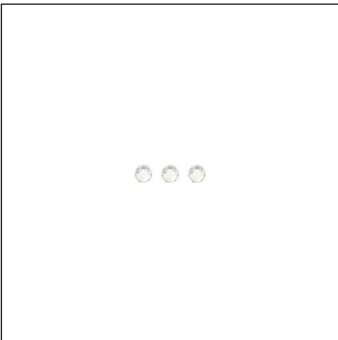

C 001MOL
 E S8
 S ~982x2 (281 SEG/ROW)
 M 18 ROWS **100%**

11 473

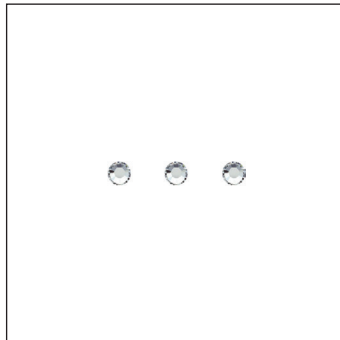

C 001
 E S12
 S ~978x3 (131 SEG/ROW)
 M 14 ROWS **100%**

11 494

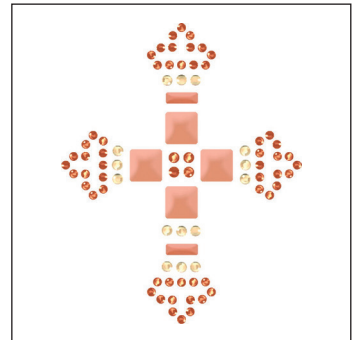

C 080/090-001ROGL/261/
 001ROGL
 E M7x7/M7x3-S6/S8/S8
 S ~53x66
 M 64 PCS **60%**

11 609

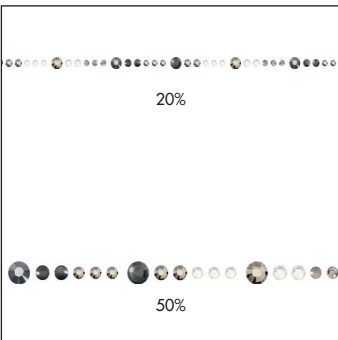

C 001SSHA/284/001MOL/001SINI/
 001SSHA/001MOL/280HEM/
 001SSHA/001SINI
 E S16/S16/S16/S20/S20/S20/S34/
 S34/S34
 S ~938x7 (8 SEG/ROW)
 M 9 ROWS

11 633

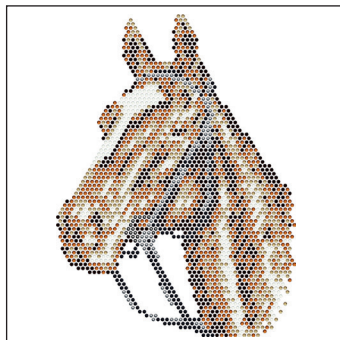

C 220/286/001GSHA/001MOL/
 280/280HEM/001COS
 E S6/S6/S6/S6/S6/S6/S6
 S ~127x170
 M 7 PCS **25%**

11 759

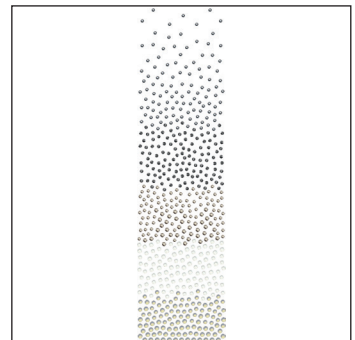

C 001SINI/280HEM/001SSHA/
 001MOL/234/001SSHA/234/
 001MOL
 E S6/S6/S6/S8/S8/S8/S10/S10
 S ~51x192
 M 16 PCS **23%**

11 786



C 213SAT/550/001MIGLD/
001GSHA
E S6/S6/S6/S6
S ~124x170
M 10 PCS **25%**

12 116

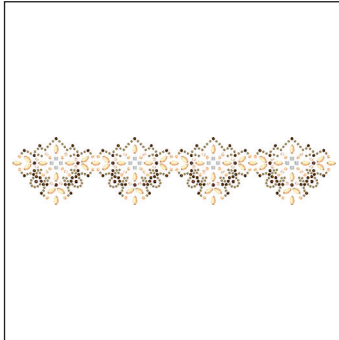

C 001GSHA/001/001MIGLD/
001BRSH/001GSHA/220/391
E CS8x4/CS3x3/S6/S8/S10/S10/
S12
S ~266x56
M 9 PCS **16%**

18 585

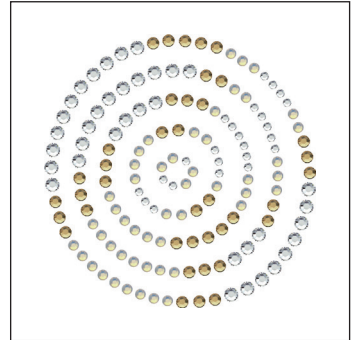

C 001/234/001GSHA/001
E S6/S8/S10/S12
S ~60x60
M 42 PCS **60%**

13 282

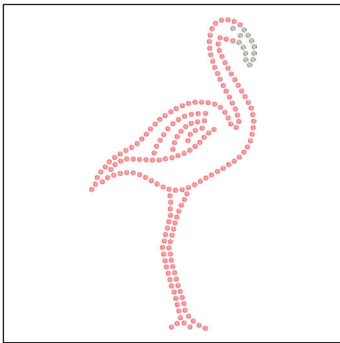

C 223/001
E PP7/PP7
S ~42x80
M 6 PCS **52%**

13 283

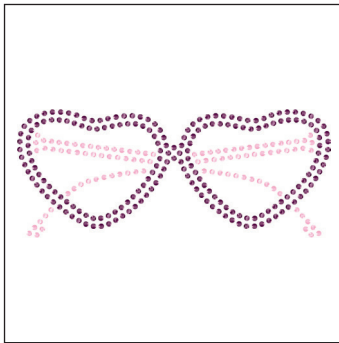

C 204/223
E S3/S3
S ~77x31
M 36 PCS **54%**

13 284

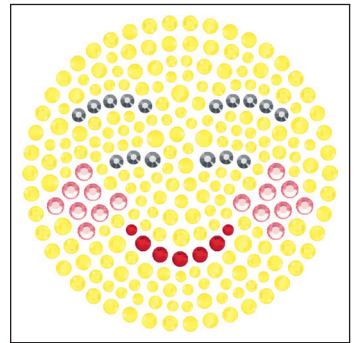

C 231/227/231/280HEM/231/
227/280HEM/223/231
E S6/S6/S8/S8/S10/S10/S10/
S12/S12
S ~73x71
M 20 PCS **78%**

13 287

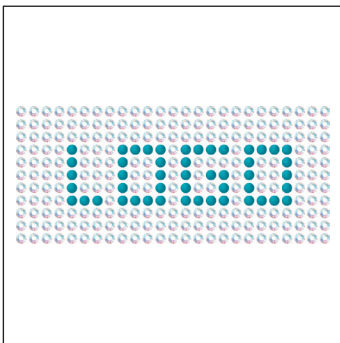

C R5009-001AB
E M2-S6
S ~59x26
M 84 PCS **70%**

13 289



C 001ITCH
E S6
S ~231x39
M 16 PCS **18%**

13 290

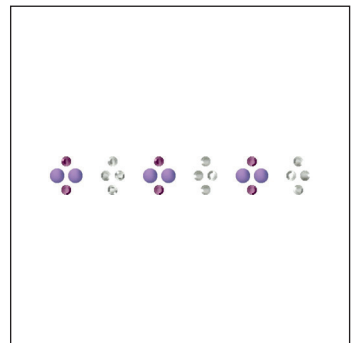

C R4005-001SSHA/204
E M2-S3/S3
S ~506x5 (41 seg/row)
M 15 ROWS **100%**

13 291

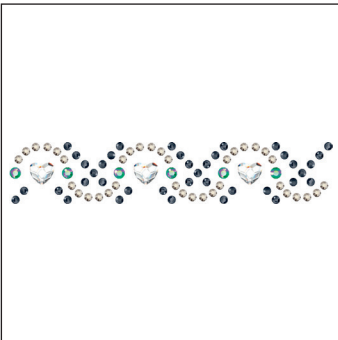

C 001/253/001SSHA/001SCGR
E 2808MM60/S6/S6/S10
S ~979x15 (39 seg/row)
M 9 ROWS **55%**

13 293

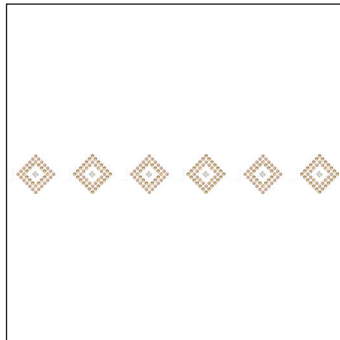

C R1019/R9003-001/001GSHA/246
E M2/M7x7-CS3x3/S6/S6
S ~976x22 (15 seg/row)
M 7 ROWS **23%**

13 294

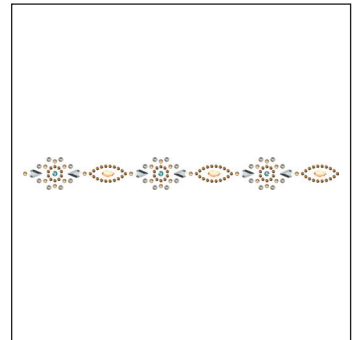

C 001LTCH/001GSHA/001DOR/
001GSHA/215/001SCGR
E CS8x5/CS8x4/S6/S8/S10/S12
S ~951x19 (15 seg/row)
M 7 ROWS **22%**

13 298

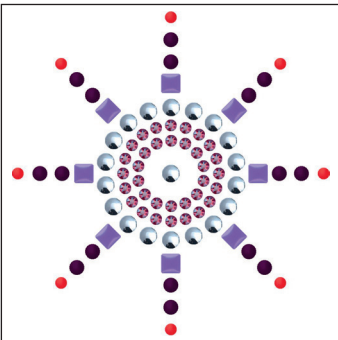

C R3020/R4007/R4005-001LTCH/
227SHIM
E M2/M2,5/M3x3-P3/S6
S ~52x53
M 48 PCS **80%**

13 300

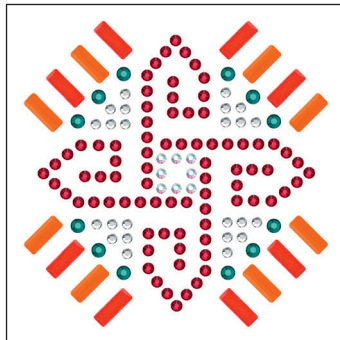

C R3020/R2003-001/001AB/
276/229
E M7x3/M7x3-S5/S5/S6/S8
S ~50x51
M 48 PCS **80%**

13 302

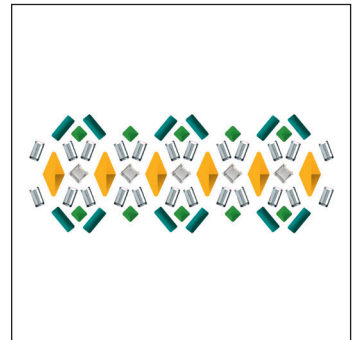

C R6018/R5021/R1018-001/001
E M3x3/M7x3/M12x6-CS5x2,5/
CS4x4
S ~80x31
M 50 PCS **50%**

13 303

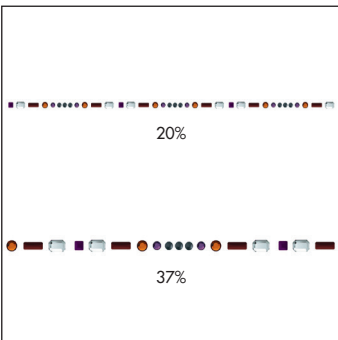

C R4007/R8012-280HEM/001/
204/220
E M3x3/M7x3-P3/CS6x4/S12/S16
S ~956x4 (13 seg/row)
M 12 ROWS

13 304

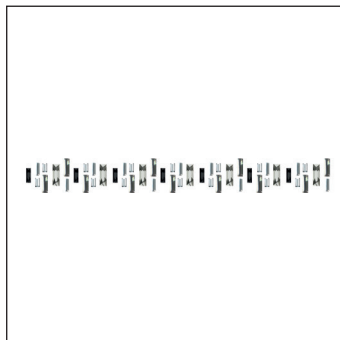

C 096/092-001/280/001SSHA
E M10x3/M7x3-CS5x2,5/
2555MM8x2,6/2555MM12x4
S ~174x19
M 35 PCS **23%**

13 306



C 280HEM/280/001GSHA/
280HEM/001MLGLD/001SCGR/
253/204
E CS5x2/CS5x2,5/CS4x4/S6/S6/
S8/S10/S12
S ~48x83
M 39 PCS **50%**

13 308

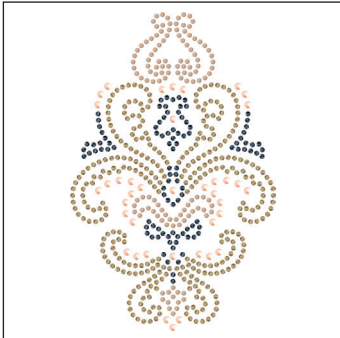

C R1019-001GSHA/001MIGLD/253
 E M2P3/S6/S6
 S ~82x127
 M 16 PCS **33%**

13 309

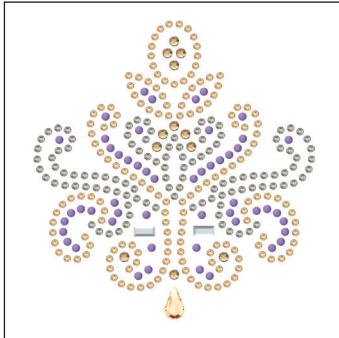

C R4005-001GSHA/001ITCH/246/
 215/001GSHA
 E M2-CS8x5/CS5x2,5/S5/S5/S8
 S ~67x71
 M 39 PCS **56%**

13 321

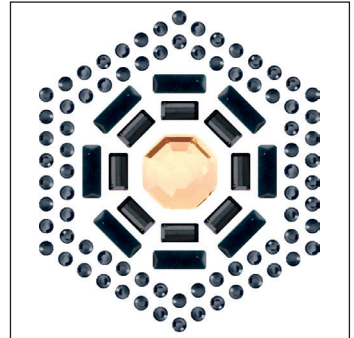

C R9005-280HEM/001GSHA/253
 E M7x3-CS5x2,5/2611MM10/S6
 S ~37x43
 M 84 PCS **100%**

13 339



C 001SINI
 E 2856MM10x7.5
 S ~18x10
 M 232 PCS **100%**

13 340

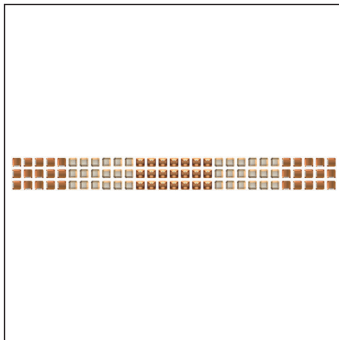

C 001GSHA/001GSHA/001GSHA
 E CS4x4/2402MM4/2403MM4
 S ~152x15
 M 48 PCS **28%**

13 336

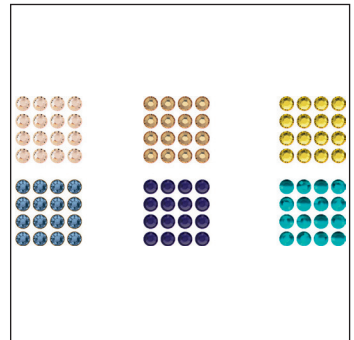

C 391/246/249/246SHIM/
 391SHIM/249SHIM
 E S16/S16/S16/S16/S16/S16
 S ~87x40
 M 36 PCS **50%**

13 337

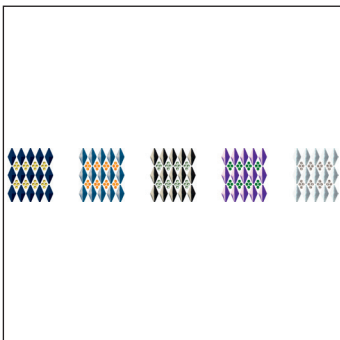

C R2003/R6018/R1018/R6032/
 R7045/249/291/259/214/284
 E M12x6/M12x6/M12x6/M12x6/
 M12x6-S6/S6/S6/S6/S6
 S ~230x37
 M 8 PCS **19%**

13 338

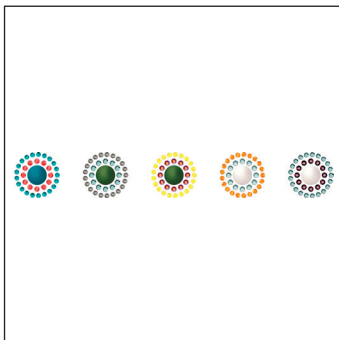

C R6018/R2003/R1018/R6032/
 R7045/360/215/263/259/231/
 001L113S/001L114S/001L116S/
 001L112S/001L115S
 E M10/M10/M10/M10/M10-S8S8/
 S8/S8/S8/S10/S10/S10/S10
 S ~163x23
 M 14 PCS **26%**

13 368

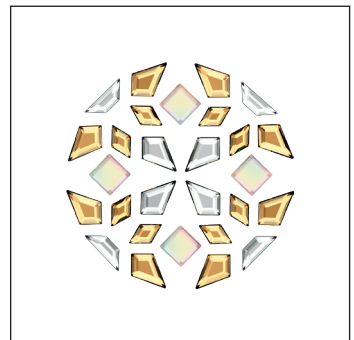

C 001AB/001GSHA/001/001/
 001GSHA
 E 2402MM4/2771MM6,4X4,2/
 2771MM6,4X4,2/2772MM6,5X2,1/
 2773MM5X3
 S ~30x30
 M 110 PCS **100%**

13 369

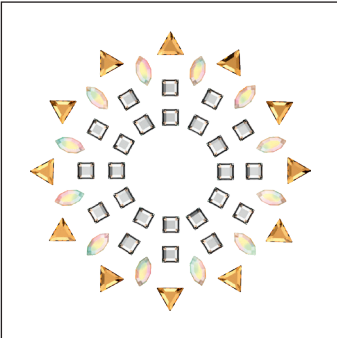

C 001AB/001/001GSHA
E 2200MM4X2/2400MM2/
2711MM3,3
S ~37x37
M 76 PCS **100%**

13 370

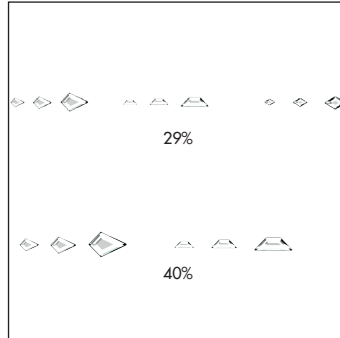

C 001/001/001/001/001/001/
001/001/001
E 2771MM6,4X4,2/2771MM8,6X5,6/
2771MM12,9X8,3/2772MM6,5X2,1/
2772MM8,6X2,8/2772MM12,9X4,2/
2773MM5X3/2773MM6,6X3,9/
2773MM9,9X5,9
S ~153x8
M 50 PCS

13 371

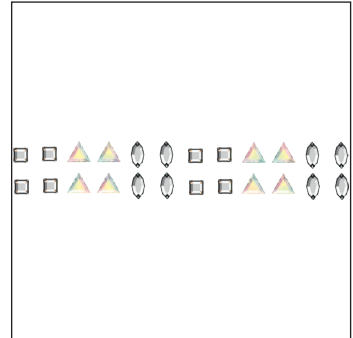

C 001/001/001AB
E 2200MM4X2/2400MM2/
2711MM3,3
S ~56x9
M 126 PCS **79%**

13 373

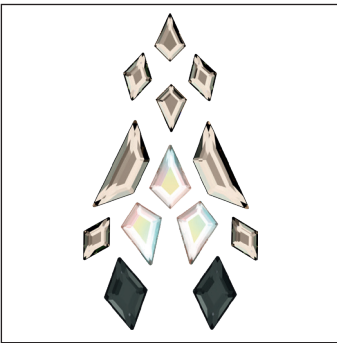

C 001SSHA/001AB/001SSHA/
001SSHA/215
E 2771MM6,4x4,2/2771MM8,6x5,6/
2772MM12,9x4,2/2773MM6,6x3,9/
2773MM9,9x5,9
S ~23x41
M 104 PCS **100%**

ALL-OVER MOTIFS

11 461

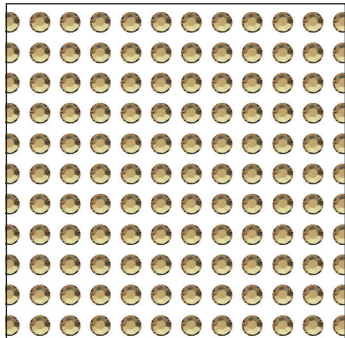

| | |
|----------|-------------------|
| C | 001GSHA |
| E | S10 |
| S | ~478x210 |
| M | 2 PCS 100% |

TRANSFERS UNLIMITED

13 141

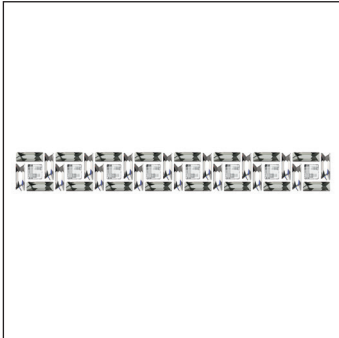

C 001/001/001SSHA
E 2493MM8/2555MM15x5/
 2555MM15x5
S ~173x21
M 13 PCS **24%**

13 142

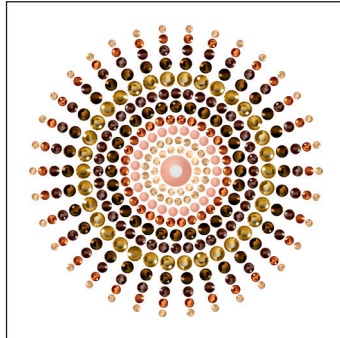

C 090/090-246/001GSHA/001COP/
 220/001BRSH/001DOR
E M2.5/M8-S6/S6/S8/S10/S12/
 S16
S ~74x74
M 10 PCS **52%**

13 144

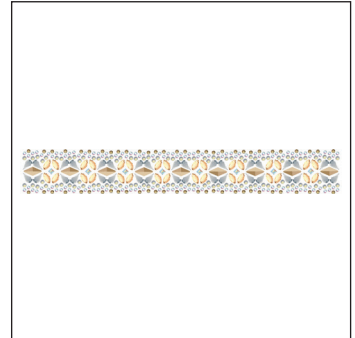

C 094-001/001GSHA/001AB/
 001AB/001GSHA/234
E M12x6-CS8x5/CS8x4/CS3x3/
 S8/S8/S10
S ~210x29
M 12 PCS **20%**

13 146

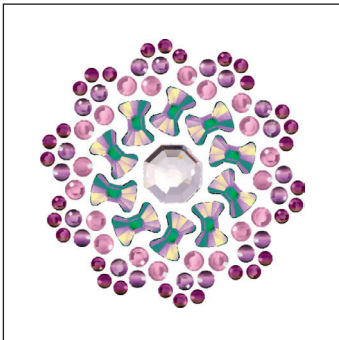

C 001/001PARSH/001IISH/
 001ANTP/212
E 2611MM8/2858MM6x4.5/S6/
 S8/S10
S ~35x36
M 55 PCS **100%**

13 147

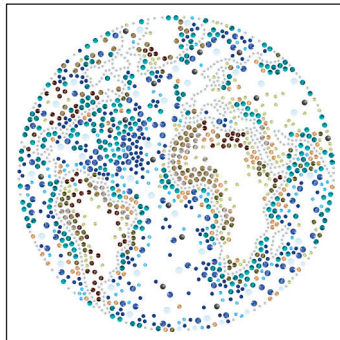

C 001617/001PBLUHFT/001PBLUHFT/
 001/243/001LUMG/202/246/
 220/550/263/229/263/
 001MIGLD/284/206
E P3/P3/P4/S5/S6/S6/S6/S8/S8/
 S8/S8/S10/S10/S10/S10/S12
S ~168x167
M 2 PCS **25%**

13 148

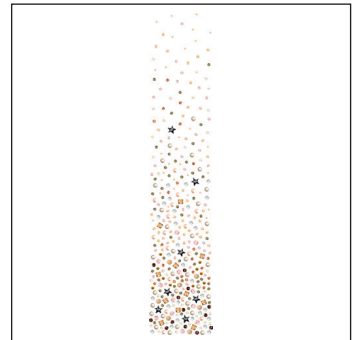

C 091/094-001295/001GSHA/
 001GSHA/280HEM/001GSHA/
 001MIGLD/319/001GSHA/
 001AB/001ROGL/220/234/319
E M2/M3-P3/P3/CS3x3/2817MM5/
 S3/S6/S6/S6/S6/S6/S8/S10/S12
S ~41x212
M 9 PCS **20%**

13 311

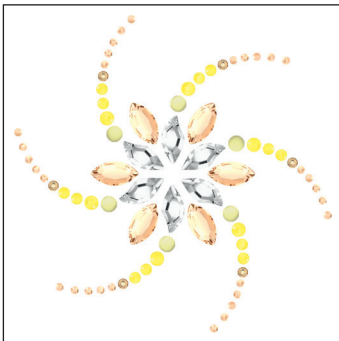

C 01GSHA/001/001GSHA/246/
 231/231/001PYELHFT
E CS8x4/2797MM8x4/S3/S5/S6/
 S8/S10
S ~52x52
M 24 PCS **80%**

13 312



C 001SSHA/001GSHA/001LTCH
E 2555MM8x2,6/25040MM9x7/S6
S ~112x45
M 10 PCS **36%**

13 313

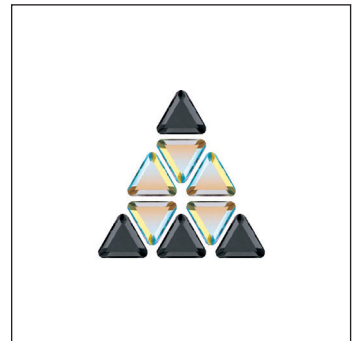

C 001AB/280HEM
E CS7x6/CS7x6
S ~22x22
M 72 PCS **100%**

13 314



C 001BLAPA/001SSHA/001
E 2493MM8/2555MM15x5/
 2555MM15x5
S ~86x21
M 26 PCS **46%**

13 315

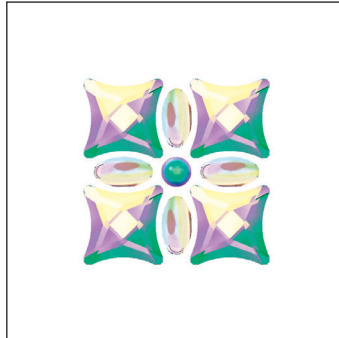

C 001SCGR/001AB/001PARSH
E P4/CE8x4/2494MM10,5
S ~25x25
M 78 PCS **100%**

13 316

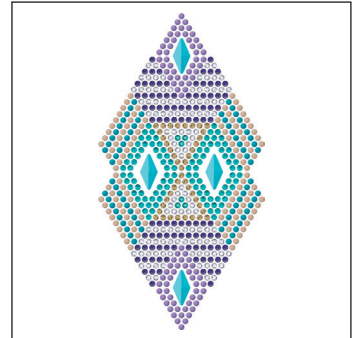

C R1019/R4005/R5009/071-265/
 263/277/001MIGLD/229
E M2/M2/M2/M12x6-S6/S6/S6/
 S6/S6
S ~55x105
M 15 PCS **40%**

13 317

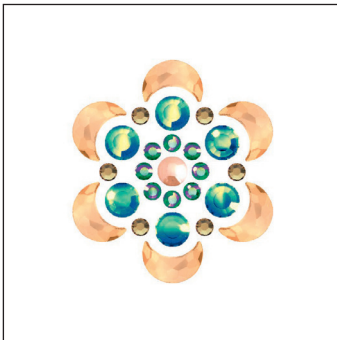

C 001GSHA/001GSHA/001SCGR/
 001GSHA/001IRIG
E P4/2813MM8X5,5/S8/S8/S20
S ~26x29
M 60 PCS **100%**

13 318

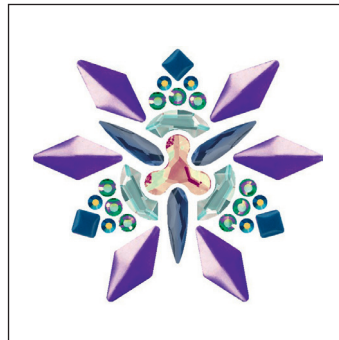

C R5009/R4005-001/001AB/
 280AB/001SCGR/001BLSH
E M3X3/M12X6-2037MM8/
 2708MM8X8,7/S6/
 S8/2304MM10X2,8
S ~38x33
M 50 PCS **100%**

13 319

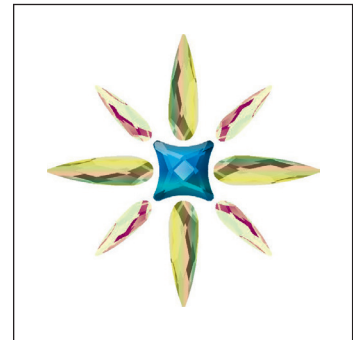

C 001BBL/001AB/001LUMG
E 2494MM8/2304MM10X2,8/
 2304MM14X3,9
S ~38x33
M 40 PCS **100%**

13 320

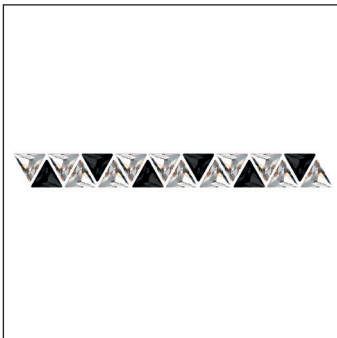

C 001/280
E 2720MM7,5/2720MM7,5
S ~76x8
M 45 PCS **55%**

CRYSTAL INSPIRATION COLLECTION

Extensive trend research allows Swarovski to present its own Crystal Inspiration Collections twice a year.

These collections reflect the trends of coming fashion seasons (Spring/Summer and Fall/Winter) and include new and innovative design ideas, shapes, and colors in tune with these trends.

FALL/WINTER 2007/08 – SPRING/SUMMER 2016

12 906

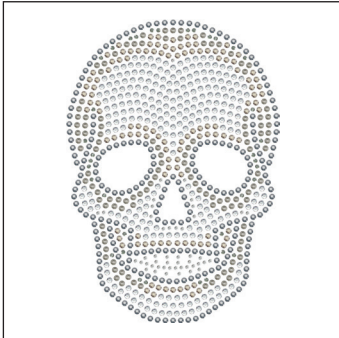

C 001/215/001/280HEM/
001SSHA/215
E S3/S3/S6/S6/S6/S6
S ~71x100
M 12 PCS **40%**

12 928

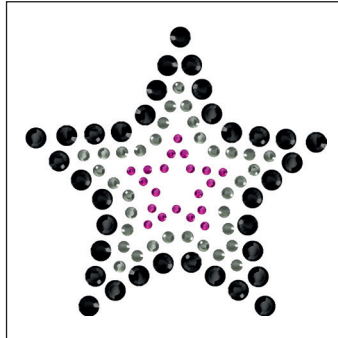

C 502/215/280
E S6/S10/S20
S ~66x64
M 24 PCS **60%**

13 058

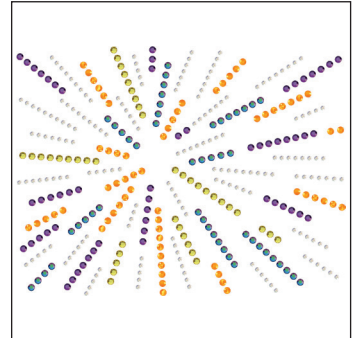

C 001AB/259/001VOL/001MBL/226
E S3/S6/S6/S6/S6
S ~91x69
M 15 PCS **48%**

CRYSTAL INSPIRATION COLLECTION

13 062

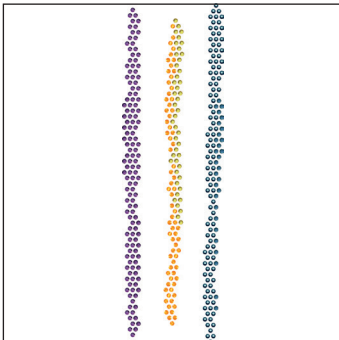

C 001METBL/001VOL/259/226/
204/207
E S6/S6/S6/S6/S6/S6
S ~44x146
M 24 PCS **31%**

13 073



C 280HEM/220/280NUT/220
E CS5x2.5/S6/S10/S16
S ~101x81
M 22 PCS **43%**

13 075

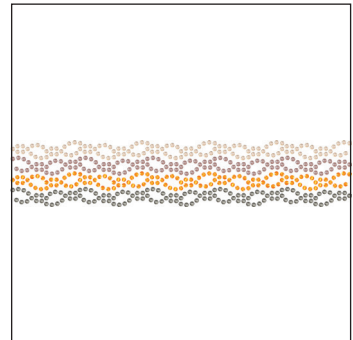

C 391/319/259/215
E S8/S8/S8/S8
S ~185x36
M 21 PCS **24%**

13 088

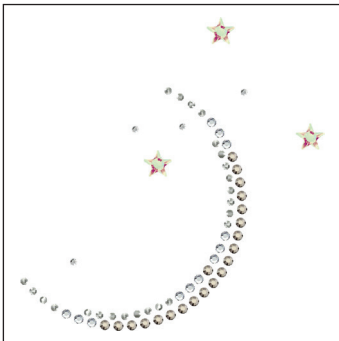

C 001AB/001SSHA/001/001/
001SSHA
E 2817MM5/S3/S3/S5/S6
S ~57x59
M 36 PCS **70%**

13 089

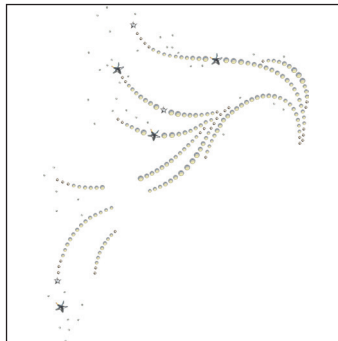

C 092001/001SSHA/001SSHA/
234/234/234/234
E MST2817MM5/S3/S6/S8/S10/
S12/S16
S ~175x221
M 3 PCS **20%**

13 090



C 082/082-215/001SSHA/001SINI/
001SINI/383/001SINI
E M2/M2.5-S6/S6/S6/S8/S8/S10
S ~162x244
M 4 PCS **17%**

13 096

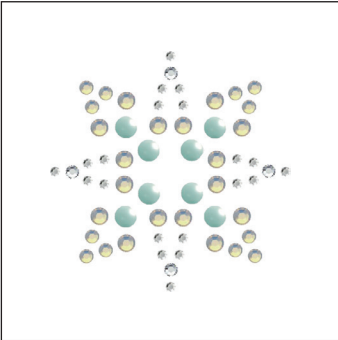

C 001616/001/001/234/234
E P3/S3/S5/S6/S8
S ~32x32
M 78 PCS **100%**

13 098

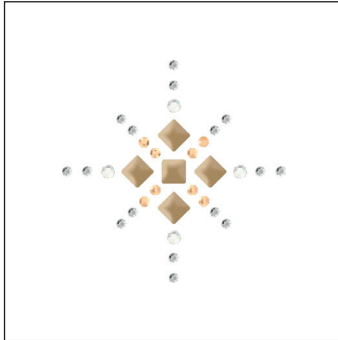

C 094-001/001GSHA/001MOL
E M3X3-S3/S3/S6
S ~29x29
M 144 PCS **100%**

13 100

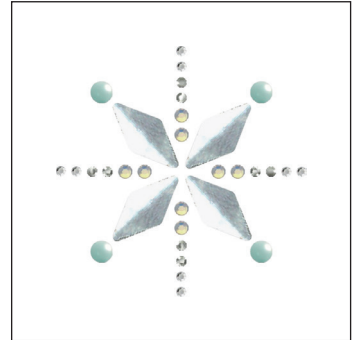

C 082-001616/001/001SSHA/234
E M12X6-P3/S3/S3/S6
S ~33x33
M 65 PCS **100%**

13 103

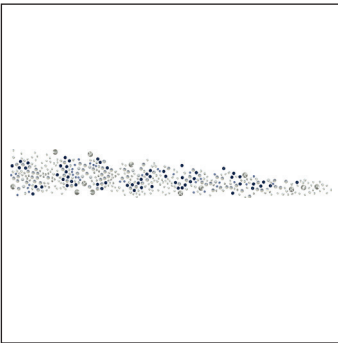

C 001LTC/001MOL/001SSHA/
001BLSH/001MOL/207/383/
234/001SSHA
E P3/S6/S6/S6/S8/S10/S12/S12/
S20
S ~283x42
M 12 PCS **15%**

13 104

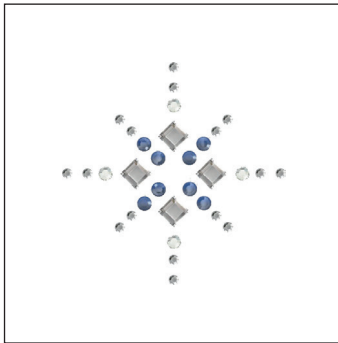

C 001/001/001BLSH/001MOL
E CS3X3/S3/S6/S6
S ~29x29
M 144 PCS **100%**

13 105

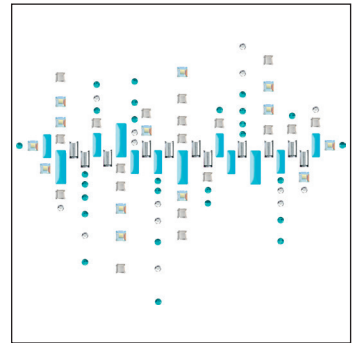

C 071/071-001/001/001AB/
263/001
E M10x3/M7x3-CS5x2,5/CS3x3/
CS3x3/S6/S6
S ~97x77
M 22 PCS **45%**

13 107

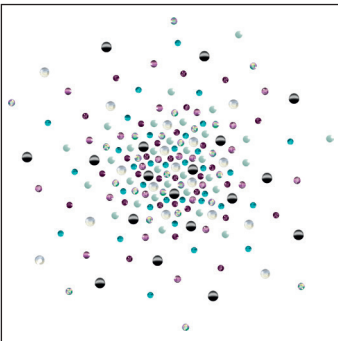

C 001616/280HEM/263/204/
001ANTP/001PARSH/234
E P3/P4/S8/S8/S10/S10/S16
S ~123x118
M 7 PCS **35%**

13 108

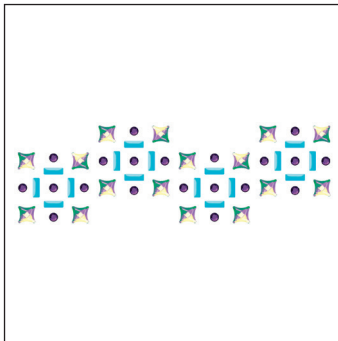

C 071-001PARSH/204
E M7x3-2494MM6/S12
S ~112x35
M 28 PCS **37%**

13 112

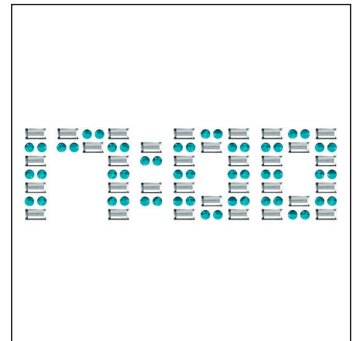

C 001/263
E CS5x2,5/S8
S ~75x22
M 66 PCS **55%**

13 113

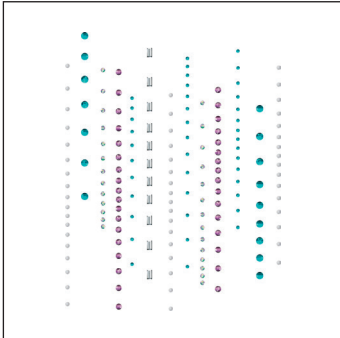

C 092-001/263/001PARSH/
001ANTP/263
E M2,5-CS5x2,5/S6/S8/S12/S16
S ~114x147
M 8 PCS **25%**

13 119

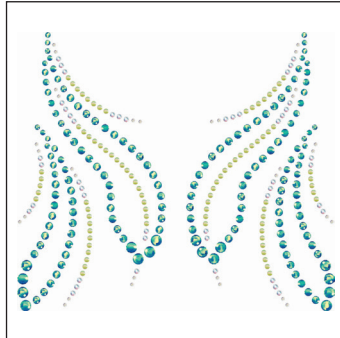

C 001AB/001AB/001LUMG/001IRIG/
001IRIG/001IRIG/001IRIG
E S3/S5/S6/S6/S8/S10/S16
S ~110x97
M 8 PCS **38%**

13 120

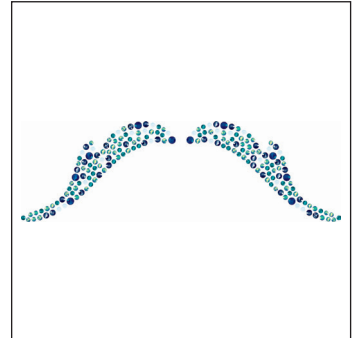

C 001PBLUHFT/229/001IRIG/
001IRIG/001METBL/243
E P3/S8/S8/S10/S12/S16
S ~169x53
M 15 PCS **25%**

13 122

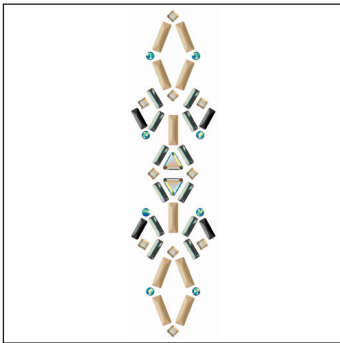

C 094/096/070-001GSHA/001AB/
001IRIG
E M10X3/M7X3/M7X3-CS3X3/
CS7X6/S10
S ~28x108
M 48 PCS **40%**

13 123

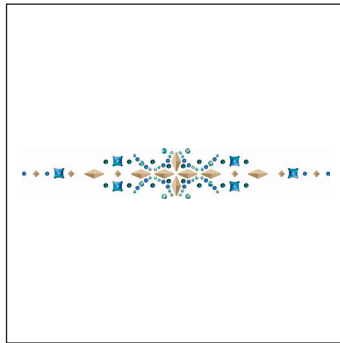

C 094/094-001BBL/001IRIG/243/
229SAT/001IRIG
E M3X3/M12X6-2494MM6/S6/S8/
S10/S12
S ~184x30
M 25 PCS **22%**

13 133

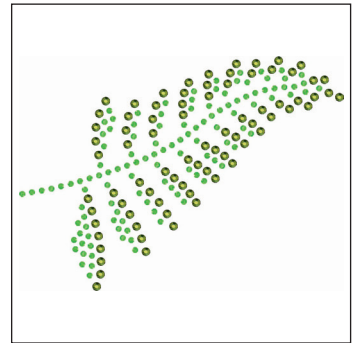

C 214/228
E S3/S6
S ~72x52
M 36 PCS **60%**

13 135

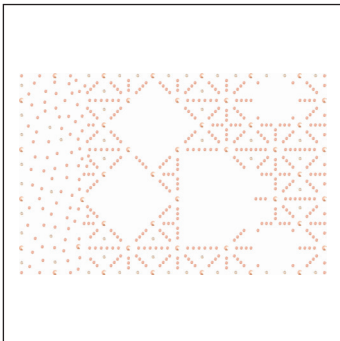

C 080-001205/391
E M2-P3/S6
S ~184x120
M 7 PCS **22%**

13 140

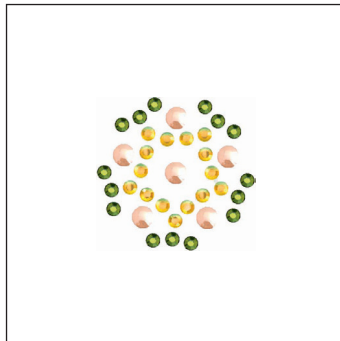

C 001205/001METSH/228
E P3/S6/S6
S ~21x20
M 224 PCS **100%**

FALL/WINTER 2016/17

13 149

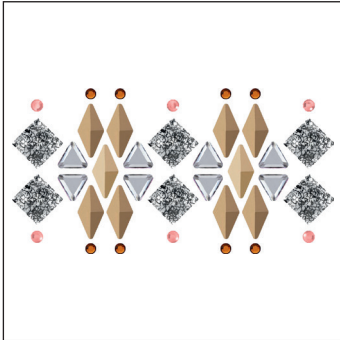

C 084/094-001/001BLAPA/220/257
E M12X6/M12X6-CS7X6/2493MM8/S8/S10
S ~71x36
M 44 PCS **60%**

13 150

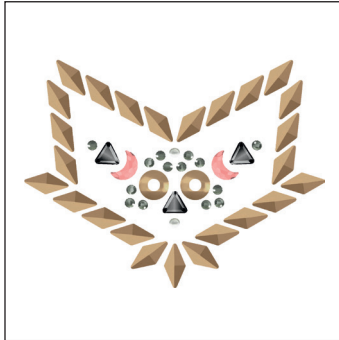

C 084/084-001ITCH/280HEM/257/215
E M8/M12X6-P3/CS7X6/2813MM8X5,5/S10
S ~79x60
M 33 PCS **50%**

13 151

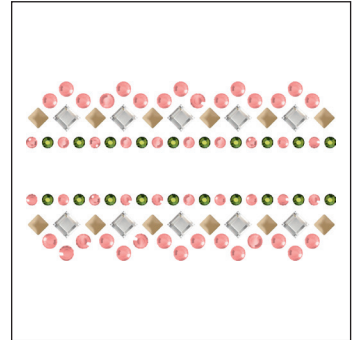

C 094-001/257/228/257
E M3X3-CS4X4/S8/S8/S12
S ~63x37
M 60 PCS **65%**

13 153

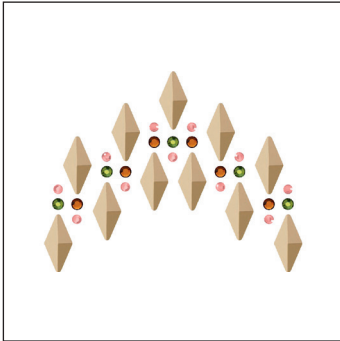

C 094-257/220/228
E M12X6-S6/S8/S8
S ~52x41
M 64 PCS **65%**

13 154

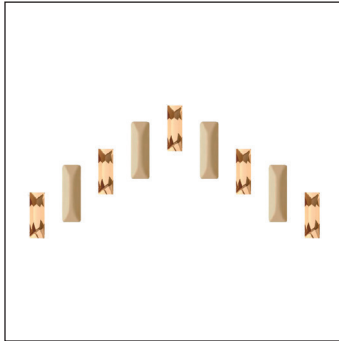

C 094-001GSHA
E M10X3-2555MM8X2,6
S ~51x23
M 75 PCS **75%**

13 161

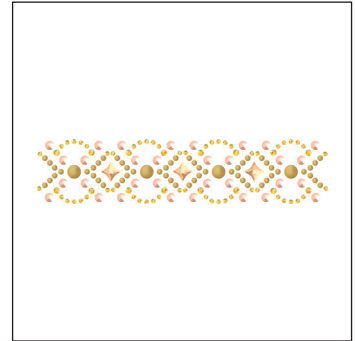

C 091/091-001GSHA/001GSHA/001METSH/001METSH
E M2,5/M6-P4/2494MM6/S6/S10
S ~128x28
M 35 PCS **30%**

13 162

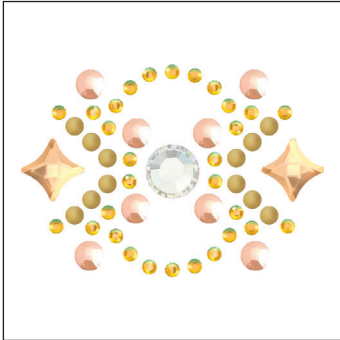

C 091-001GSHA/001GSHA/001METSH/001MOL
E M2,5-P4/2494MM6/S6/S34
S ~40x28
M 96 PCS **100%**

13 167



C 280HEM/001ITCH/001/001/001SINI/227/001
E P4/P7/2770MM60X35/2770MM120X70/2714MM60/2714MM140/2813MM14X9,5
S ~37x40
M 36 PCS **100%**

13 170

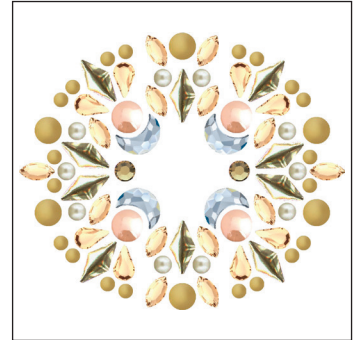

C 091/091/091-001291/001GSHA/001GSHA/001GSHA/001/001GSHA
E M3/M6/M12X6-P4/P7/CS8X5/CS8X4/2813MM10X7/S20
S ~72x61
M 18 PCS **60%**

13 174

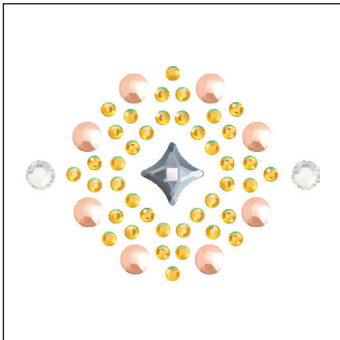

C 001GSHA/001/001METSH/
001MOL
E P4/2494MM6/S6/S16
S ~39x28
M 120 PCS **100%**

13 175



C 091-001GSHA/001GSHA/
001MOL/234/001MOL
E M12X6P3/CS8X4/2813MM8X5,5/
2753MM10/S10
S ~32x34
M 110 PCS **100%**

13 176

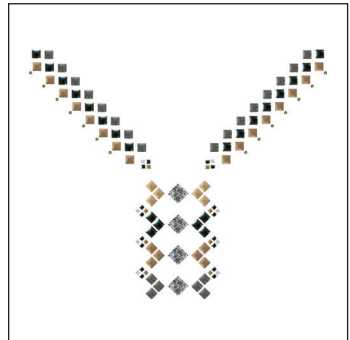

C 086/096/084/094/096/
084-001/001BLAPA/228
E M7X7/M7X7/M7X7/M7X7/M3X3/
M3X3-CS3X3/2493MM12/S8
S ~245x206
M 3 PCS **16%**

13 183

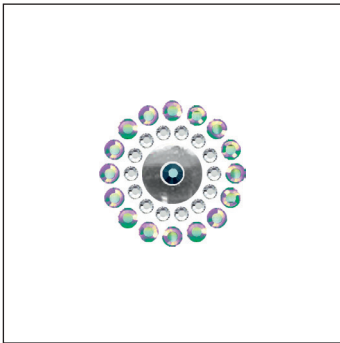

C 092-001/001SCGR/001METBL
E M8-S6/S10/S10
S ~19x19
M 112 PCS **100%**

13 184

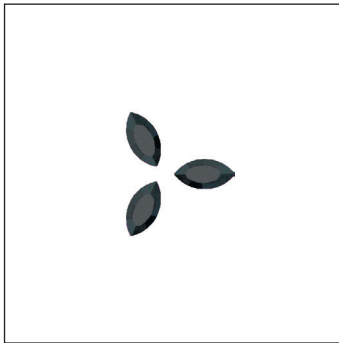

C 280HEM
E CS8X4
S ~14x16
M 264 PCS **100%**

13 190

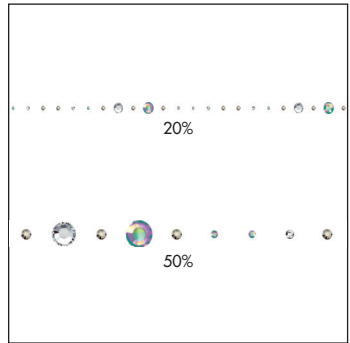

C 001SCGR/001ITCH/001SSHA/001/
001SCGR
E S6/S8/S10/S30/S34
S ~952x7 (8 SEG/ROW)
M 8 ROWS

13 193

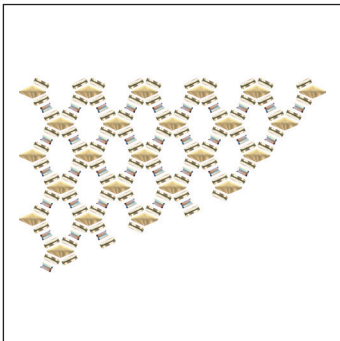

C 091/081-001AB
E M7X3/M12X6-CS5X2,5
S ~135x85
M 12 PCS **30%**

13 194

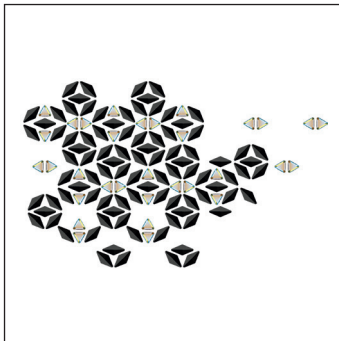

C 070/070-001AB
E M12X6/M12X6-CS7X6
S ~161x98
M 10 PCS **25%**

13 200

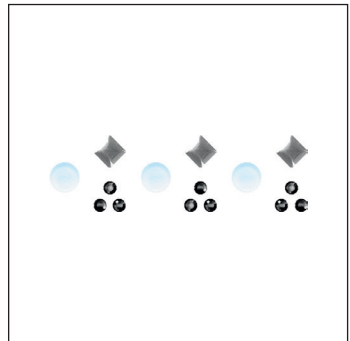

C 082/001PBLUHFT/280HEM
E M3X3-P4/S5
S ~982x10 (82 SEG/ROW)
M 11 ROWS **100%**

13 201

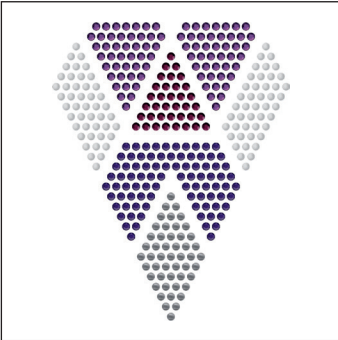

C 092/086-277/204/515
E M2/M2-S6/S6/S6
S ~57x72
M 39 PCS **55%**

13 205



C 082-277/001SCGR/280AB/
001LUMG
E M2-S6/S6/S6/S6
S ~191x23
M 29 PCS **22%**

13 206

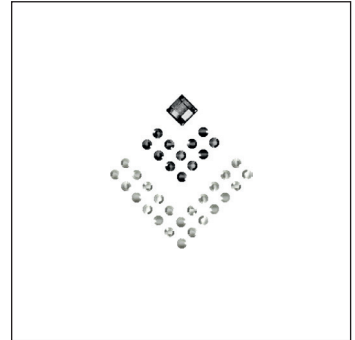

C 280HEM/001SSHA/280HEM
E CS3X3/S3/S3
S ~19x20
M 220 PCS **100%**

13 208



C 070-001LTCH/001SSHA
E M2-S6/S6
S ~16x31
M 234 PCS **100%**

13 209



C 096/071-001LTCH/280AB
E M2/M2-S6/S6
S ~33x47
M 96 PCS **80%**

13 210

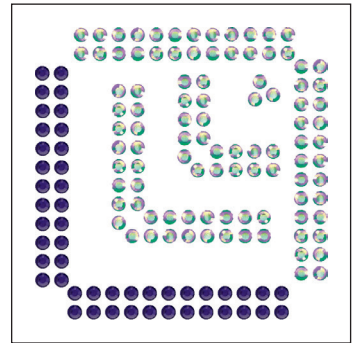

C 001SCGR/277
E S6/S6
S ~39x39
M 80 PCS **100%**

SPRING/SUMMER 2017

13 214

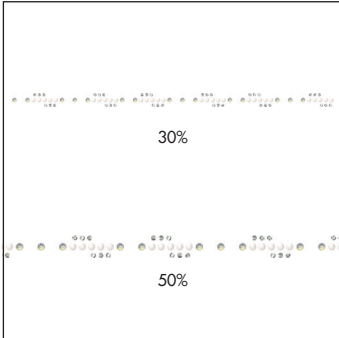

C R9003/001SSHA/234
 E M2/S3/S6
 S ~474x6 [10 SEG/ROW]
 M 14 ROWS

13 217

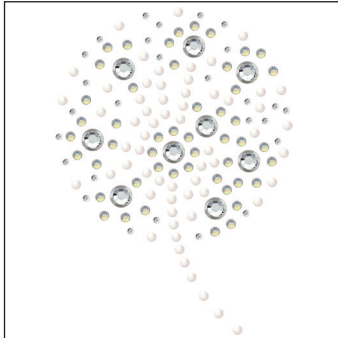

C 001 SR/R9003/001/234
 E FFB16/M2/S3/S6
 S ~46x64
 M 32 PCS 100%

13 219

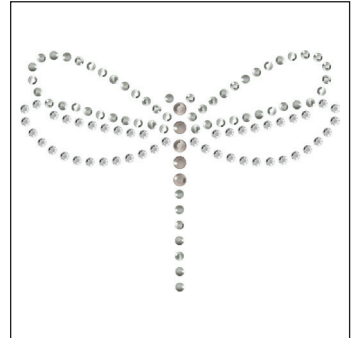

C 001SSHA/001/284
 E S3/S3/S6
 S ~47x36
 M 40 PCS 90%

CRYSTAL INSPIRATION COLLECTION

13 220

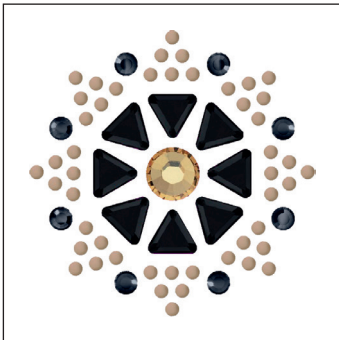

C R1019/280/253/246
 E M2/CS7x6/S12/S34
 S ~38x38
 M 84 PCS 100%

13 221

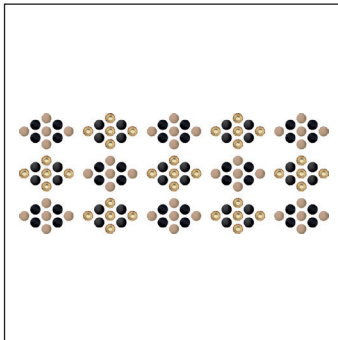

C R1019/R9005/246/280
 E M2/M2/S6/S6
 S ~58x23
 M 90 PCS 70%

13 222

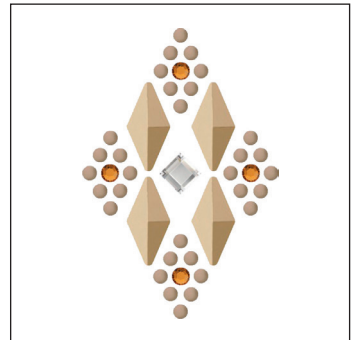

C R1019/094/001/203
 E M2/M12x6/CS4x4/S8
 S ~26x38
 M 120 PCS 100%

13 223

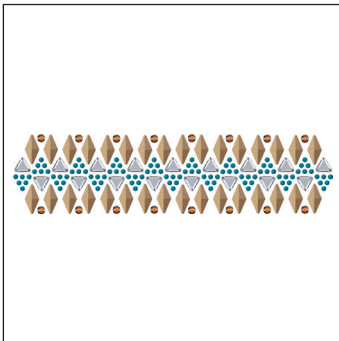

C R5009/084/001/001COP
 E M2/M12x6/CS7x6/S12
 S ~128x32
 M 30 PCS 33%

13 224

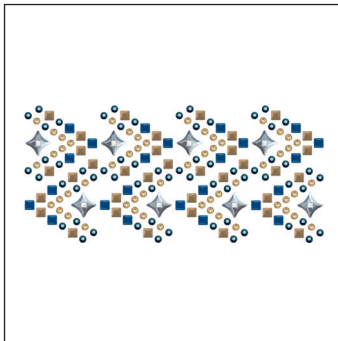

C 084/R5009/001/001METBL/246
 E M3x3/M3x3/2494MM6/S8/S8
 S ~98x45
 M 36 PCS 40%

13 225

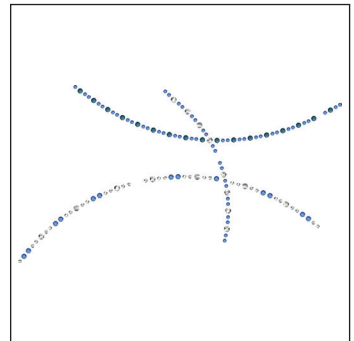

C 206/001LTCH/207/206/001LTCH
 E S6/S6/S10/S10/S12
 S ~171x94
 M 10 PCS 25%

13 228

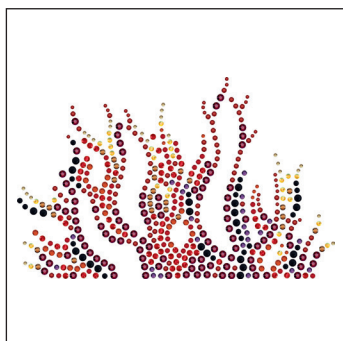

C 280/280/001GSA/208/236/
208/227/001METSH/204/327/
236/001COP/227SAT

E P3/P4/S6/S6/S6/S10/S10/S10/
S10/S12/S12/S12/S16

S ~168x106

M 4 PCS **25%**

13 230



C 001SINI/001SINI/001BLAPA

E 2205MM10/2205MM14/
2034SS20

S ~25x24

M 174 PCS **100%**

13 231

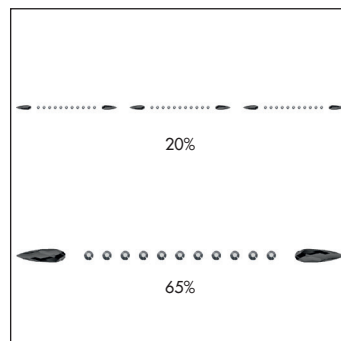

C 280HEM/001SINI

E S6/2304MM10x2,8

S ~967x3 (13 SEG/ROW)

M 11 ROWS

13 233

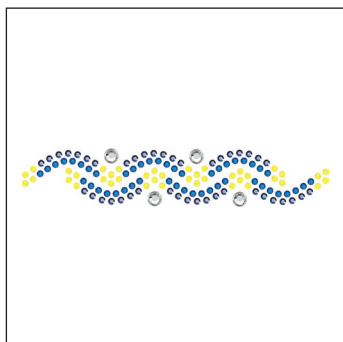

C 001 SR/243/206SAT/231

E FFB16/S6/S6/S6

S ~90x17

M 63 PCS **45%**

13 234



C 001AB/266/213AB/263

E CE8x4/S6/S6/S6

S ~41x35

M 95 PCS **100%**

13 235

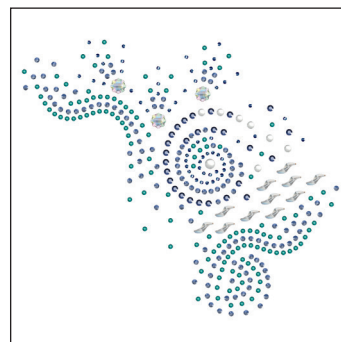

C 001650/001650/001/001METBL/
229/001BLSH/206SAT/001AB

E P3/P4/2788MM8/S3/S5/S6/S8/
2612MM6

S ~119x104

M 8 PCS **35%**

13 236

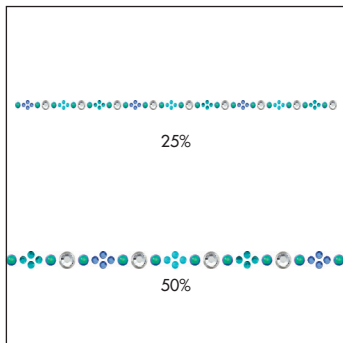

C 001 SR/071/001SCGR/206/263

E FFB16/M2/P3/S6/S6

S ~967x4 (17 SEG/ROW)

M 11 ROWS

13 237

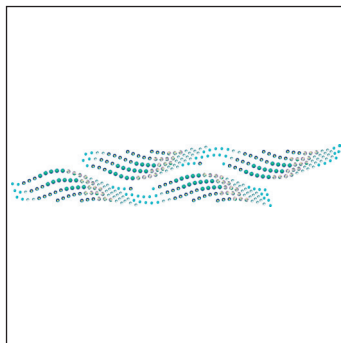

C 071/001SCGR/202/280AB/
001SCGR

E M2/P3/S6/S8/S10

S ~217x41

M 19 PCS **20%**

13 238



C 001/280HEM/001AB/001/001/
001SINI

E FFB20/FFB20/2205MM10/
2205MM10/2205MM14/
2205MM14

S ~131x18

M 36 PCS **30%**

13 239

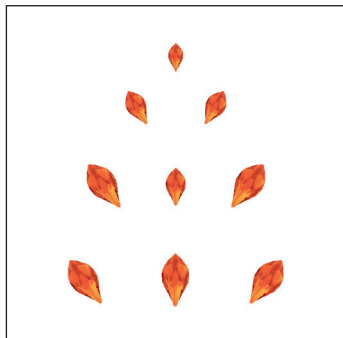

| | | |
|----------|---------------------------------|------------|
| C | 237/237/237 | |
| E | 2205MM7,5/2205MM10/ 2205MM14 | |
| S | ~57x69 | |
| M | 33 PCS | 50% |

FALL/WINTER 2017/18

13 242

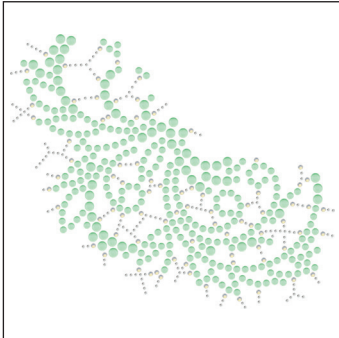

C 001PGRHFT/001PGRHFT/
001/234

E P3/P4/S3/S6

S ~134x113

M 6 PCS **32%**

13 243

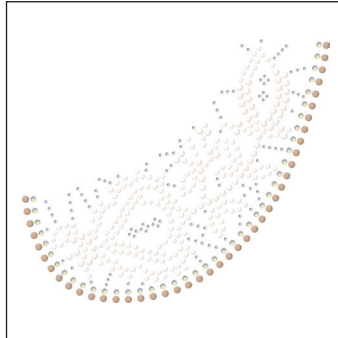

C R9003/R9003/R1019-001/234

E M2/M2,5/M2,5-S3/S6

S ~107x91

M 10 PCS **38%**

13 244

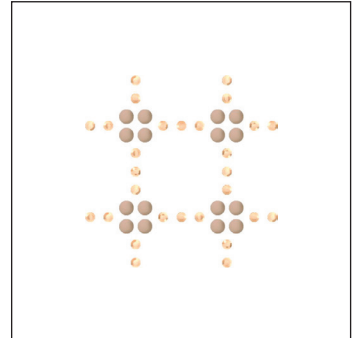

C R1019-001GSHA

E M2-S3

S ~25x25

M 105 PCS **100%**

13 245

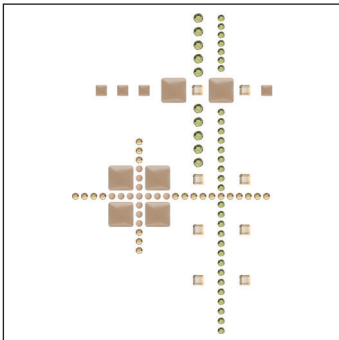

C R1019/R1019/R1019-001GSHA/
550/001GSHA/550

E M2/M7x7/M3x3-CS3x3/S6/S6/
S10

S ~57x92

M 33 PCS **46%**

13 246

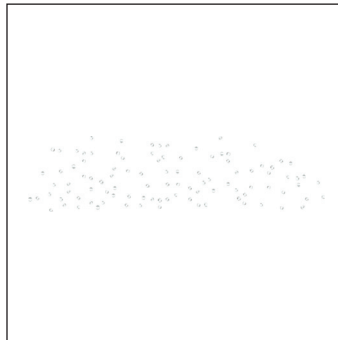

C 001HFT/001HFT

E S8/S10

S ~196x49

M 16 PCS **20%**

13 252

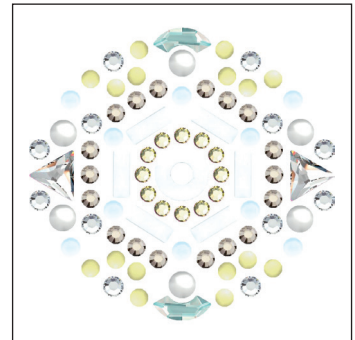

C R9003/R9003-001PBLUHFT/
001650/001/001/213/
001SSHA/001PYELHFT/001

E M8/M7x3-P3/P4/2720MM7,5/
2037MM8/S8/S10/S10/S12

S ~45x43

M 32 PCS **90%**

13 253

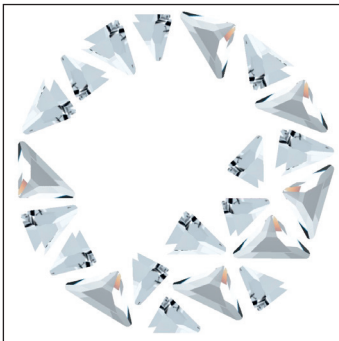

C 001/001/001

E 2739MM5,8x5,3/2739MM7x6,5/
2740MM8,3x8,3

S ~46x47

M 51 PCS **90%**

13 254

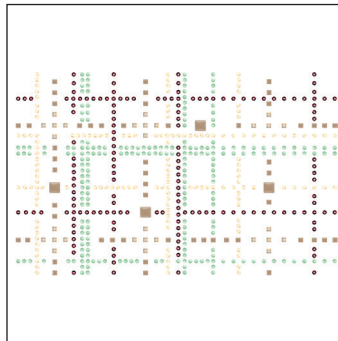

C R1019/R1019-001GSHA/
001PGRHFT/001L108S/
001L106S

E M7x7/M3x3-CS3x3/S10/S10/
S10

S ~212x134

M 6 PCS **20%**

13 255

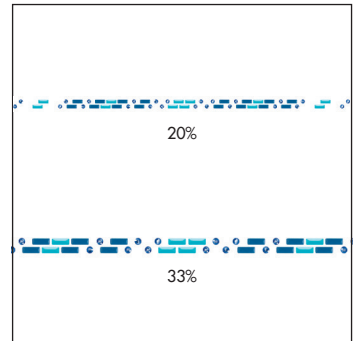

C R5009/071-L110S

E M7x3/M7x3-S10

S ~234x6

M 52 PCS

13 256

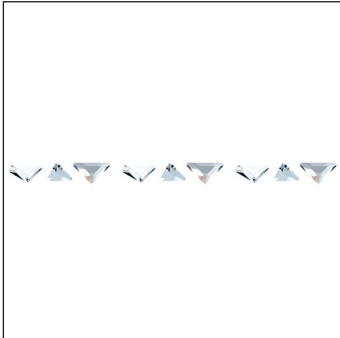

C 001/001/001
E 2738MM10x5/2739MM5,8x5,3/
 2740MM8,3x8,3
S ~973x6 (28 SEG/ROW)
M 12 ROWS **43%**

13 257

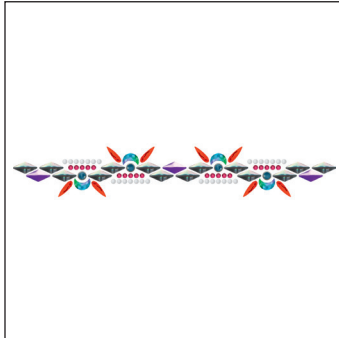

C 266 GM/092/096/
 R4005-001SCGR/501/227
E FFB16/M2,5/M12x6/
 M12x6-2813MM8x5,5/S8/
 2304MM10x2,8
S ~158x24
M 12 PCS **27%**

13 258

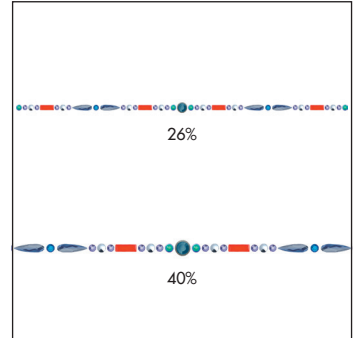

C 086266/R3020-001CHRMV/
 001SCGR/539/001BLSH/243
E FFB20/M7x3-P3/P3/S8/
 2304MM10x2,8/S10
S ~168x5
M 23 PCS

13 259

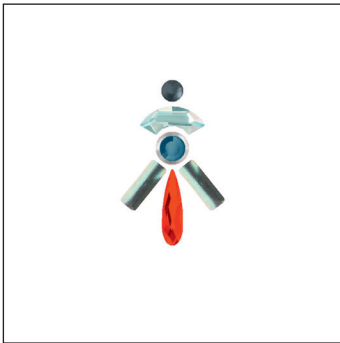

C 266 SR/096-280HEM/001/227
E FFB16/M7x3-P3/2037MM8/
 2304MM10x2,8
S ~14x22
M 117 PCS **100%**

13 260



C 266 SR/092/092-253/001SCGR/
 243/227/001SINI/539/227
E FFB16/M7x3/M12x6-CS3x3/
 2813MM8x5,5/S8/
 2304MM10x2,8/
 2304MM14x3,9/S10/S12
S ~56x55
M 21 PCS **78%**

13 261

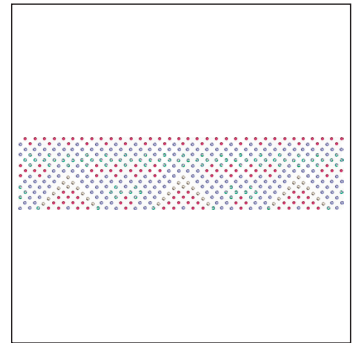

C 501/539/001SCGR/001SSHA
E S8/S10/S10/S10
S ~253x57
M 9 PCS **17%**

13 262

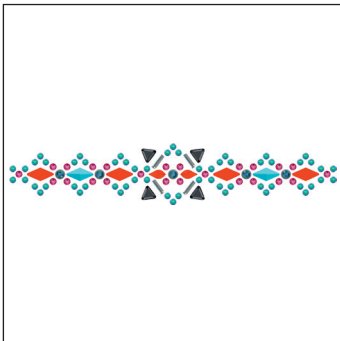

C 086266/092/R5003/R4007-
 001SCGR/280HEM/227/502
E FFB16/M7x3/M12x6/M12x6-P3/
 CS7x6/2205MM7,5/S12
S ~144x27
M 30 PCS **30%**

13 263

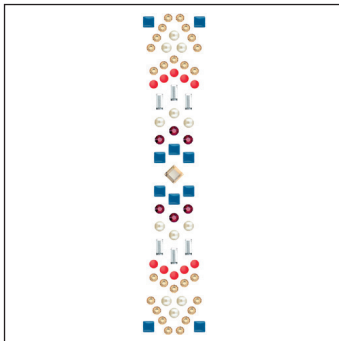

C R5021/R5009-001291/001/
 001GSHA/246/001L109S
E M2,5/M3x3-P3/CS5x2/CS4x4/
 S8/S10
S ~18x92
M 72 PCS **46%**

13 264

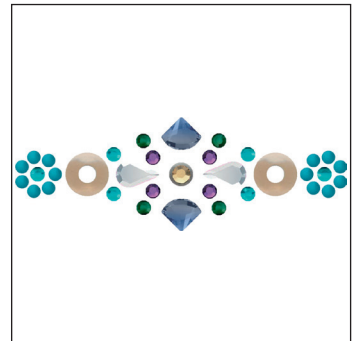

C 001GSHA GM/R5009/
 R1019-001/001BLSH/263/204/
 001L109S
E FFB16/M2,5/
 M8-CS8x5/2714MM60/S10/
 S10/S10
S ~61x21
M 90 PCS **72%**

13 265

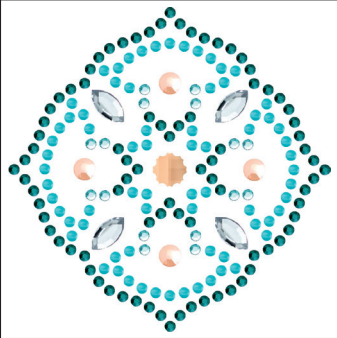

C R5021-001GSHA/001/229SAT/
202/001GSHA
E M2-P4/CS8x4/S6/S6/2612MM6
S ~57x57
M 51 PCS **74%**

13 266

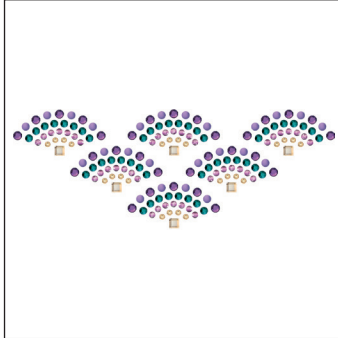

C R4005-001GSHA/246/001ANTP/
229SAT/204
E M2,5-CS3x3/S5/S6/S8/S10
S ~99x36
M 40 PCS **43%**

13 270



C 288/288/001AB/001SINI
E S6/S10/2205MM7,5/2205MM10
S ~33x38
M 45 PCS **100%**

13 274

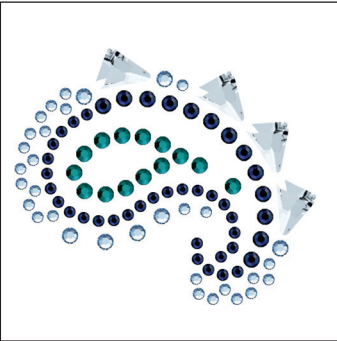

C 288/211/229SAT/288/211/000
E S6/S6/S10/S10/S10/
2739MM7x6,5
S ~49x42
M 68 PCS **81%**

SPRING/SUMMER 2018

13 322

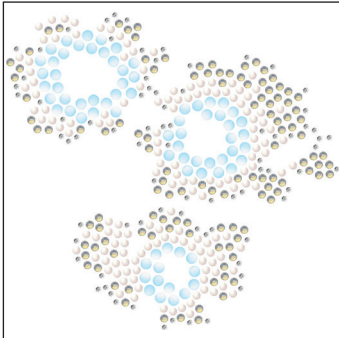

C R9003-001/234/001L104
E M2-S3/S6/S10
S ~80x76
M 12 PCS **55%**

13 323

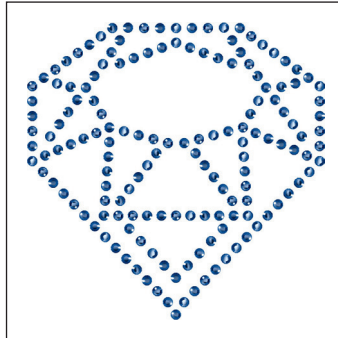

C 001L110S
E S10
S ~78x79
M 24 PCS **50%**

13 324

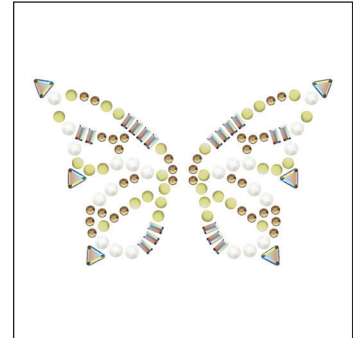

C 001AB/001AB/227AB/
001L113SHFT/502SHIM
E CS5x2.5/CS7x6/S12/S16/S20
S ~99x62
M 10 PCS **40%**

13 325

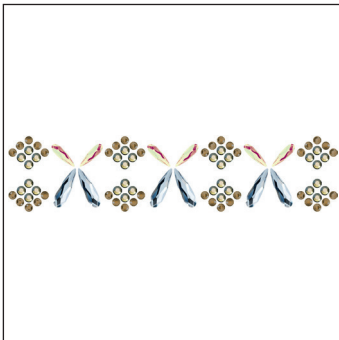

C 001AB/001/001L114SHFT/
206SAT
E 2304MM10x28/
2304MM14x3.9/S10/S12
S ~109x25
M 24 PCS **40%**

13 326

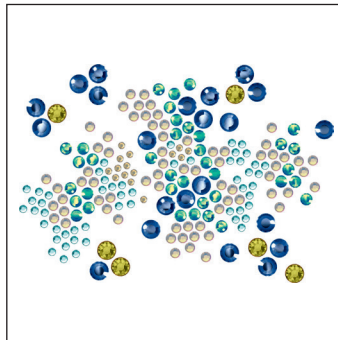

C 236SHIM/227AB/001L113SHFT/
502SHIM/236SHIM/
001L113SHFT
E S10/S12/S16/S20/S34/S34
S ~119x82
M 14 PCS **35%**

13 327

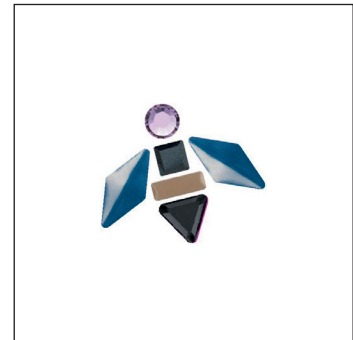

C R1019/R6018/280HEM/
280HEM/391SHIM
E M7x3/M12x6-CS4x4/CS7x6/S20
S ~22x18
M 112 PCS **100%**

13 329

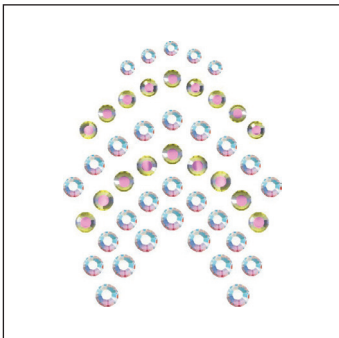

C 001AB/001TRAHFT/001AB/001TRAHFT/001AB
E S6/S8/S10/S10/S12
S ~29x35
M 110 PCS **100%**

13 330

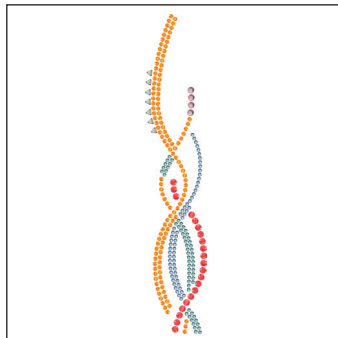

C 001AB/001L114S/502SHIM/236SHIM/001L112S/001L113S
E CS7x6/S16/S16/S20/S34/S34
S ~67x352
M 2 PCS **12%**

13 331

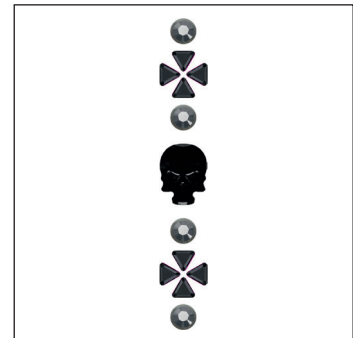

C 280HEM GM/280HEM/280HEM
E FFB34/CS7x6/2856MM18x14
S ~14x91
M 66 PCS **45%**

13 332

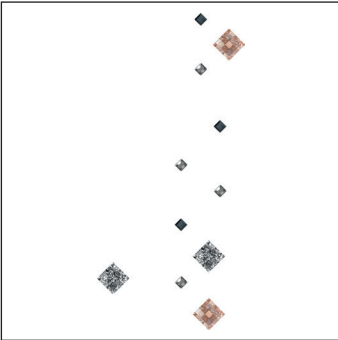

C 280HEM/001BLAPA/001ROSPA/
001

E CS4x4/2493MM10/2493MM10/
2403MM4

S ~65x139

M 21 PCS **30%**

13 333

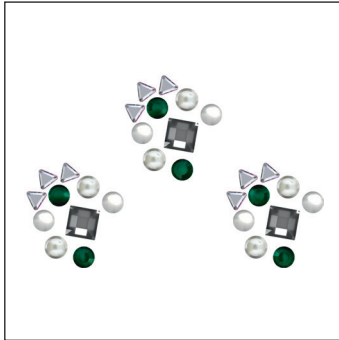

C 001191 SR/001650/001/001/
001L109SHFT

E CFFB34/P7/CS7x6/2400MM10/
S34

S ~98x64

M 22 PCS **40%**

13 334

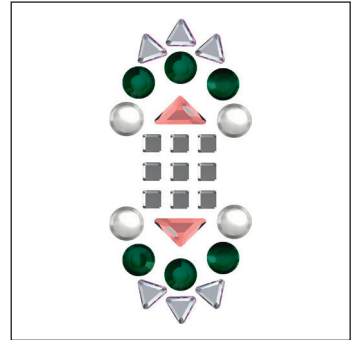

C 001650 SR/001/257/001/
001L109SHFT

E CFFB34/CS7x6/2740MM8.3x8.3/
2402MM4/S34

S ~31x67

M 48 PCS **60%**

13 335

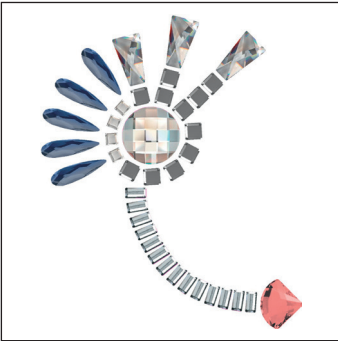

C 001/001/001/001/257/
001BLSH/001

E CS5x2.5/CS3x3/2035MM14/
2770MM120x70/2714MM100/
2304MM14x3.9/2402MM4

S ~62x76

M 15 PCS **55%**

FALL/WINTER 2018/19

13 342



C 280HEM/001SINI/280/001L111S/
215LTCHZ/253/001/001

E P4/2714MM60/2813MM8X5.5/
S10/16/2201MM8X3.5/
2303MM8X5/2602MM8X5.5

S ~21x60

M 42 PCS **68%**

13 343

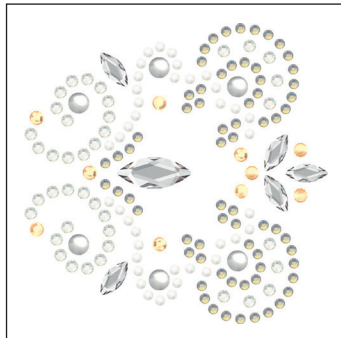

C 001650/234/279/001MOL/
001L106S/001/001

E P4/S6/S6/S8/S10/
2201MM8X3.5/2201MM14X6

S ~57x57

M 42 PCS **70%**

13 344

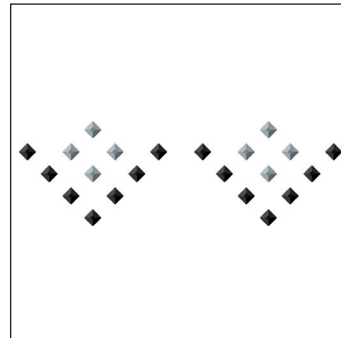

C 280/001LTCH

E 2403MM4/2403MM4

S ~104x34

M 32 PCS **40%**

13 345

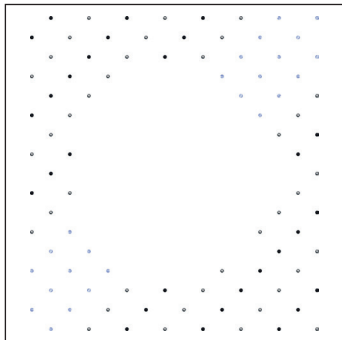

C 280HEM/280/283

E S6/S6/S6

S ~152x166

M 6 PCS **25%**

13 346

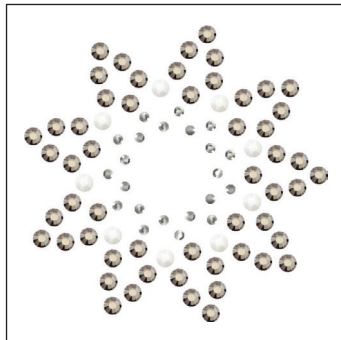

C 001SSHA/001SSHA/279

E S3/S8/S8

S ~40x39

M 40 PCS **100%**

13 347

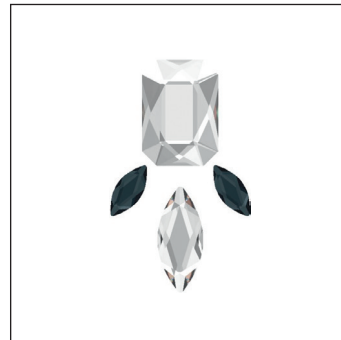

C 253/001/001

E 2201MM8X3.5/2201MM14X6/
2602MM14X10

S ~18x31

M 75 PCS **100%**

13 348

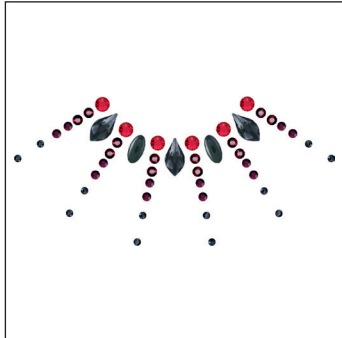

C 280HEM/253/515/001L108S/
001SINI/276

E CE8X4/S6/S8/S10/2205MM10/
S16

S ~85x39

M 21 PCS **50%**

13 349

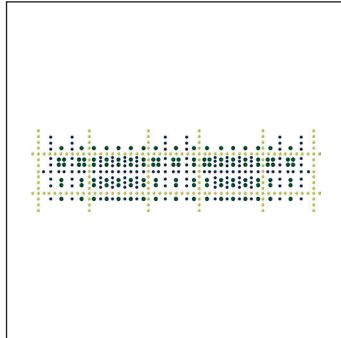

C R5003-249SHIM/001L109S

E M2-S6/S10

S ~191x54

M 15 PCS **20%**

13 350

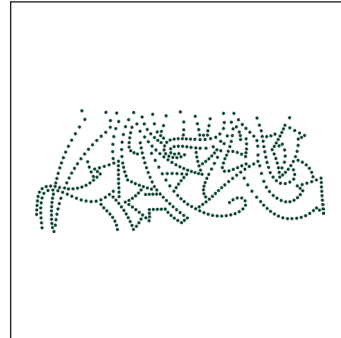

C 001L109S

E S10

S ~254x109

M 2 PCS **15%**

13 351

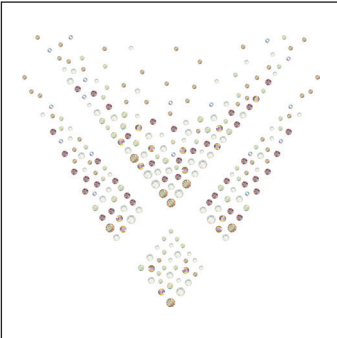

C 391SHIM/001SHIM/001MOL/001AB/
001MOL/246SHIM/001SHIM/001MOL/
001TRAHFT/391SHIM/001MOL

E S6/S6/S6/S6/S8/S10/S10/S12/
S12/S16/S16

S ~131x119

M 3 PCS **30%**

13 352

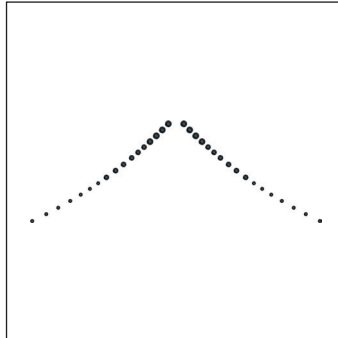

C 280ITCHZ/280ITCHZ/280ITCHZ

E S10/S16/S20

S ~192x67

M 12 PCS **20%**

13 353

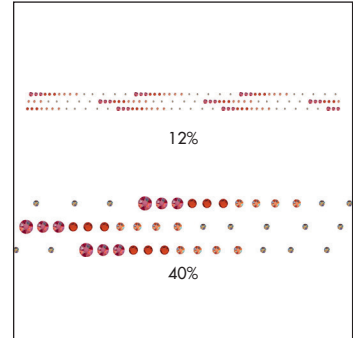

C 203SHIM/259SHIM/236/
236SHIM/236SHIM

E S6/S10/S12/S16/S20

S ~928x20 (8 SEG/ROW)

M 6 ROWS

13 354

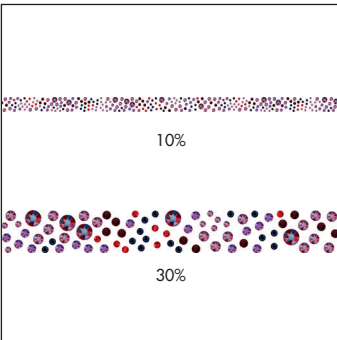

C 227SHIM/276/327/502SHIM/
515DORZ/227SHIM/208SHIM

E S10/S12/S12/S16/S16/S20/S34

S ~834x19 (3 SEG/ROW)

M 6 ROWS

SPRING/SUMMER 2019

13 355

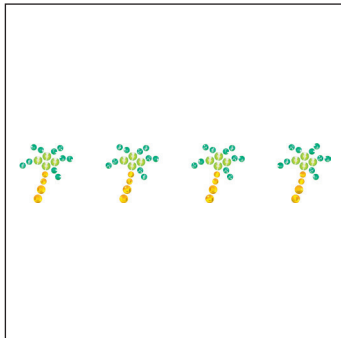

C 001L115S/226/001L125S/226
 E S10/S10/S16/S16
 S ~137x26
 M 15 PCS **30%**

13 356

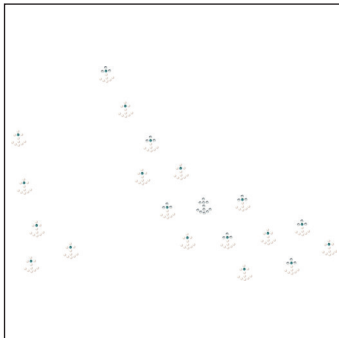

C R9003-001/296
 E M2-S6/S6
 S ~226x149
 M 5 PCS **19%**

13 357

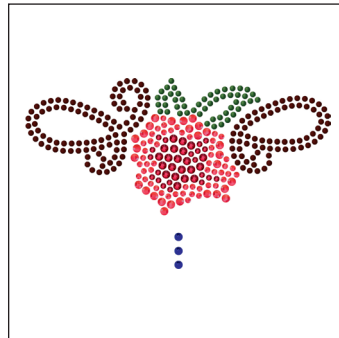

C R8012/R6025-542/276/542/
 276/296
 E M2/M2-S6/S6/S10/S10/S10
 S ~101x63
 M 12 PCS **40%**

13 358

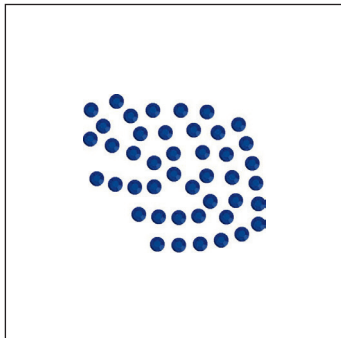

C 296
 E S6
 S ~24x21
 M 210 PCS **100%**

13 359

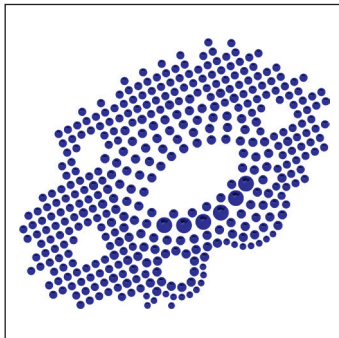

C 296/296/296/296
 E S6/S8/S10/S20
 S ~91x79
 M 12 PCS **45%**

13 360

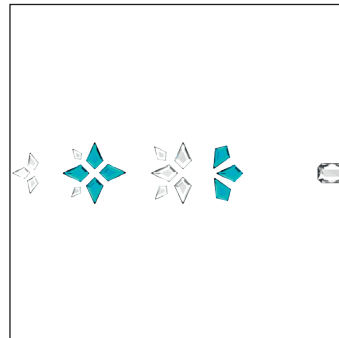

C 001/001/001/202/001
 E 2602MM14X10/2771MM6.4X4.2/
 2771MM8.6X5.6/2771MM12.9X8.3/
 2771MM12.9X8.3
 S ~164x30
 M 25 PCS **27%**

13 361

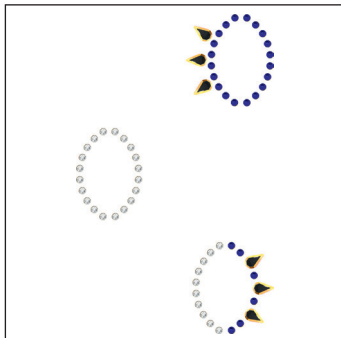

C 280DORZ/001DORZ/296
 E CS8X5/S10/S10
 S ~74x120
 M 18 PCS **35%**

13 362

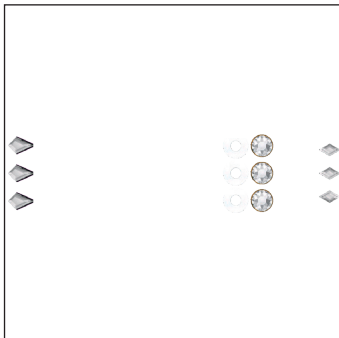

C R9003-001DORZ/001/001
 E M8-S34/2771MM8.6X5.6/
 2773MM6.6X3.9
 S ~104x25
 M 40 PCS **42%**

13 363

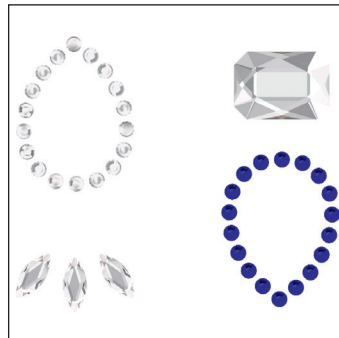

C 296/001/001/001
 E S8/S8/2201MM8X3.5/
 2602MM14X10
 S ~48X40
 M 64 PCS **90%**

13 364

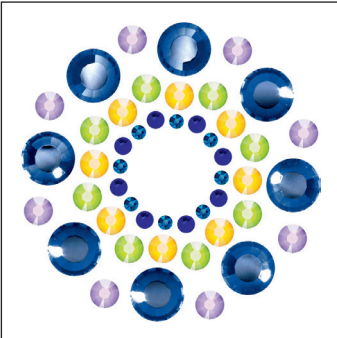

C 369SHIM/296/001L124S/
001L126S/001L125S/001L110S
E S6/S8/S16/S16/S16/S34
S ~40x40
M 68 PCS **100%**

13 365

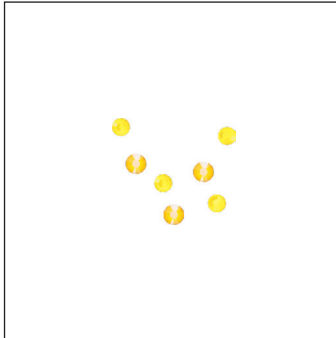

C 231/001L124S
E S8/S10
S ~16x14
M 342 PCS **100%**

13 366

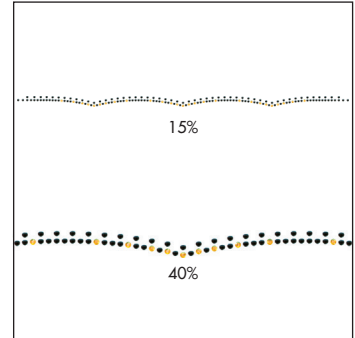

C 096-001METSH
E M2-S6
S ~292x9
M 12 PCS

13 367

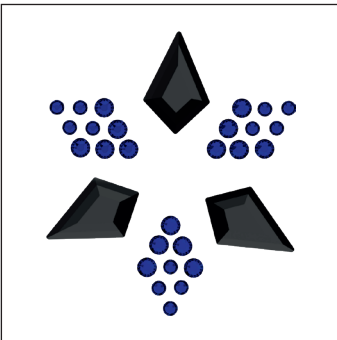

C 296/296/280HEM
E S6/S8/2771MM12.9X8.3
S ~33x37
M 84 PCS **100%**

FALL/WINTER 2019/20

13 374

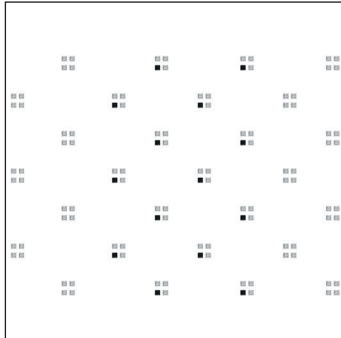

C 001/280
E 2400MM2,2/2400MM2,2
S ~144x105
M 8 PCS **30%**

13 375

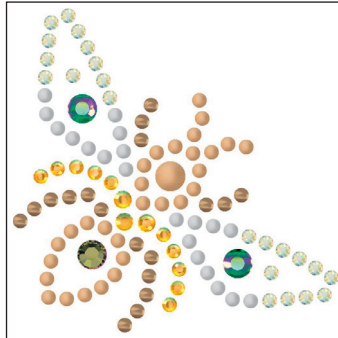

C 094/092/084/094-001SHIM/
001METSH/001METSH/467/466
E M2/M2/M2/M4-S6/S6/S8/
S16/S16
S ~43x43
M 80 PCS **100%**

13 377

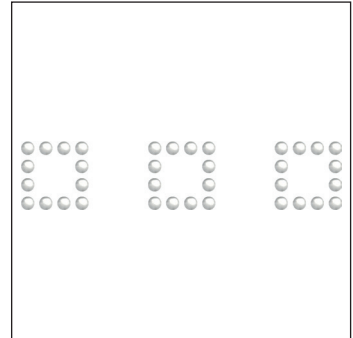

C 001650
E 20812SS16
S ~94x20
M 28 PCS **45%**

13 378

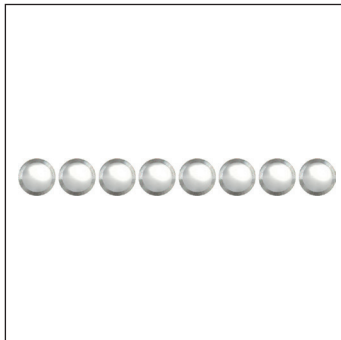

C 001650 SR
E CFFB34
S ~65x8
M 40 PCS **65%**

13 379

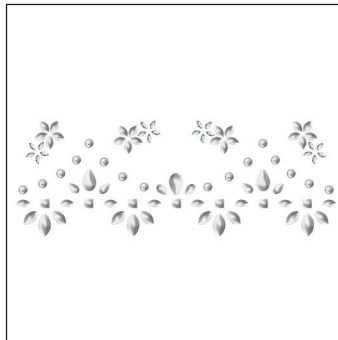

C 001191/001191/001191/001191/
001191/001191/001191/001
E 20812SS16/22084MM6X3,5/
22084MM8X4,5/22084MM10X5,5/
23084MM6X3,5/23084MM10X6/
24084MM4/2200MM4X2
S ~141x51
M 18 PCS **30%**

13 380



C 094-001191/001DORZ/
001SHIM/227SHIM
E M2-22084MM8X4,5/CS8X4/
S6/S10
S ~42x159
M 20 PCS **26%**

13 387

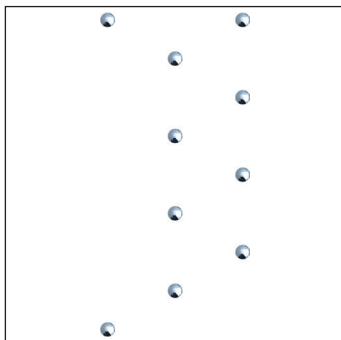

C 001ITCH
E 20812SS34
S ~73x158
M 11 PCS **27%**

13 388

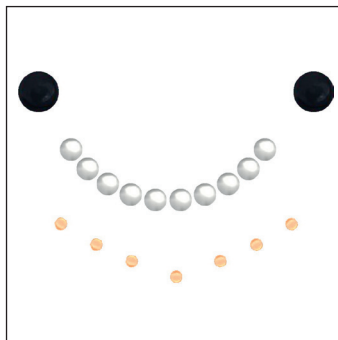

C 001769/001769/280HEM/
280HEM
E P4/P7/22084MM8X4,5/
22084MM10X5,5
S ~56x41
M 52 PCS **75%**

13 389

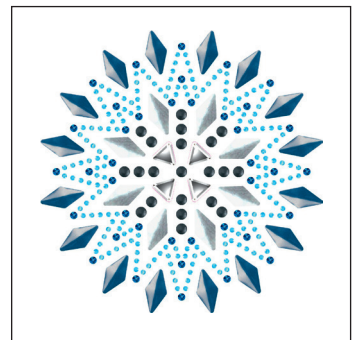

C R5009/082-1650/001ITCHZ/202/
369SHIM
E M12X6/M12X6-P3/CS7X6/S3/S6
S ~74X74
M 12 PCS **50%**

13 390

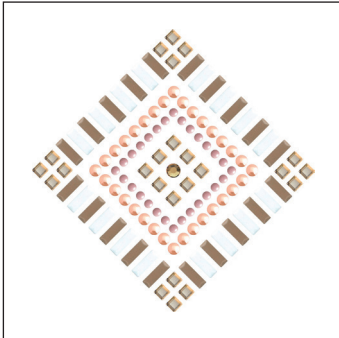

C R1019/R9003-1617/1191/
001GSHA/001GSHA

E M10X3/M10X3-P3/P4/
CS4X4/S20

S ~93X93

M 24 PCS **40%**

13 391

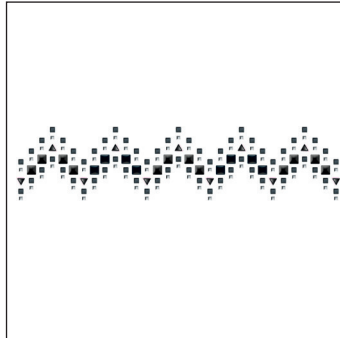

C 070/R9005-001LTCH/280HEM/
280LTCHZ

E M7X7/M7X7-CS3X3/CS4X4/
CS7X6

S ~251X56

M 9 PCS **17%**

13 392

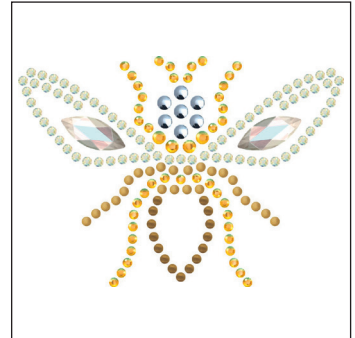

C 091/081-001LTCH/001SHIM/
001METSH/001METSH/001AB

E M2/M2-P3/S6/S6/S10/
2201MM14X6

S ~66X47

M 24 PCS **65%**

13 393

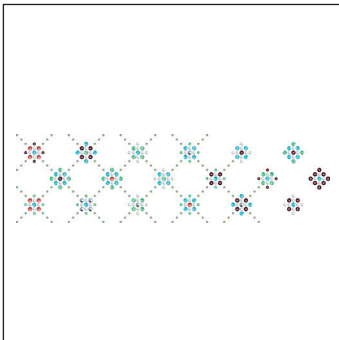

C 001650/001LTCH/390/001L115S/
001L108S/001L114S/001L108S/
001L115S/542

E P3/P4/S6/S10/S10/S16/S16/
S16/S16

S ~296X83

M 2 PCS **14%**

SPECIAL MOTIF SERVICE

A special motif is any individual design created by the customer that differs to the Transfers Standard, or Crystal Inspiration Collection. This service opens up an abundance of customization possibilities. You also no longer need to set your motif by hand. You can rely on Swarovski's long-standing experience and design expertise and can order a convenient, ready-to-apply design. A range of customization options for existing motifs is available (see

"Customization Possibilities" below). You can also submit design sketches that meet your special requirements – such as a brand image or an image for a particular sales campaign or garment. This will then be made up according to your specifications using Computer Aided Design, which means that adjustments can be made easily according to your needs.

CUSTOMIZATION POSSIBILITIES

- Change of elements in an existing motif
- Change of size of an existing motif
- Logos or brand names
- Creation of pieces or rows
- Up to nine colors possible per Transfer motif

For Transfers Unlimited

- Up to 18 elements possible per transfer motif
- max. motif size: 470x205 mm

ORDERING PROCESS

Send your request with the drawing you wish to order to your nearest Swarovski sales office. Make sure you include all measurements for the desired motif. Please also indicate which product group your special motif applies to (Transfers, Crystal-it, Crystal Mesh, etc.). You will then receive a quotation including

your article number, minimum order quantity, price, and the line drawing of your special motif in PDF format. Please contact your Swarovski sales office again if any changes are required. Your special motif will be produced and delivered following your confirmation.

PLEASE NOTE

Please always submit the drawing of your desired motif to represent it in the actual size you require. A small sketch, when enlarged to the desired size, will have blurred lines that will make it difficult to correctly reproduce. Pictures or drawings representing 100% size of the design or very good quality scans in JPG, BMP, or DXF format will ensure that we have clear data to work with. These can also be sent via email or on CD-ROM. When the sketch is submitted as a hard copy by fax or email, please include a scale

legend (e.g. copy/scan with a ruler next to the drawing). This will ensure that the desired size of the motif can be identified.

Special productions are generally offered to all our customers if these are deemed to be feasible and comply with our General Terms and Conditions. Please note that ordering a design does not grant exclusive production of this design to the customer.



CRYSTAL-IT INFINITY

CRYSTAL-IT INFINITY

Crystal-it Infinity is made up of Flat Backs in different shapes, sizes, and colors (up to 9 elements per motif possible).

It is an easy-to-apply product thanks to the specially developed adhesive on the back of the stones.

You can create your own individual and exclusive Crystal-it Infinity designs with Swarovski's special motif service.

ARTICLE EXPLANATION

75 505

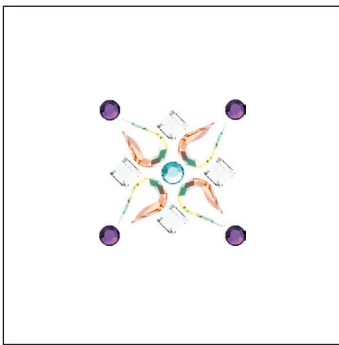

| | |
|----------|-----------------------|
| C | 204/202/001AB/001 |
| E | S10/S12/CS8x5/CS3x3 |
| S | ~19x19 (TAPE : 38x53) |
| M | 32 PCS 100% |

CRYSTAL-IT INFINITY

| 75 505 | C | E | S | M | 100% |
|----------------|--|--|--|--|------------------|
| Article number | Color assortment | Elements | Motif size in mm | Minimum order quantity in pieces (PCS) | % of actual size |
| | For further details, please refer to the color and product charts at the beginning of this chapter. Color code 1 (204) corresponds to element 1 (S10); color code 2 (202) corresponds to element 2 (S12) etc. | For details of stone sizes and element codes, please refer to the color and product charts at the beginning of this chapter. | Size of the tape the motif is attached to in mm (TAPE) | | |

P-544.545

ORDERING EXAMPLE & PRODUCT VARIETY EXPLANATION

| 75 505 | 022 | 204 | 202 | 001 AB | 001 |
|----------------|---------------------------------|---|--|---|--|
| Article number | Carrier film color 022 White | Crystal color corresponding to element 1, color of most frequently used element in the motif. Please see the respective color chart for all available reference codes. | Crystal color corresponding to element 2, color of second most frequently used element in the motif. | Crystal color corresponding to element 3, color of third most frequently used element in the motif. | Crystal color corresponding to element 4, color of fourth most frequently used element in the motif. |

FLAT BACKS FOR CRYSTAL-IT INFINITY

2038 XILION Rose

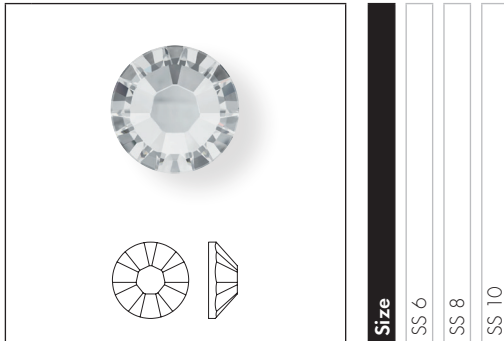

Size
SS 6
SS 8
SS 10

Crystal

Crystal (001)

Colors

Plain Colors

- Amethyst (204)
- Aquamarine (202)
- Citrine (249)
- Fern Green (291)
- Fuchsia (502)
- Greige (284)
- Indian Siam (327)
- Jet (280)
- Light Peach (362)
- Light Rose (223)
- Montana (207)
- Peridot (214)
- Sapphire (206)
- Siam (208)
- Smoked Topaz (220)
- Tanzanite (539)
- Topaz (203)

Crystal Effects

Transparent Effects

- Crystal AB (001 AB)
- Crystal Golden Shadow (001 GSHA)
- Crystal Silver Night (001 SINI)
- Crystal Silver Shade (001 SSHA)

Metallic Effects

- Crystal Dorado (001 DOR)
- Crystal Light Chrome (001 LTCH)
- Crystal Metallic Light Gold (001 MIGLD)

Color Effects

Metallic Effects

- Jet Hemalite (280 HEM)

2078 XIRIUS Rose

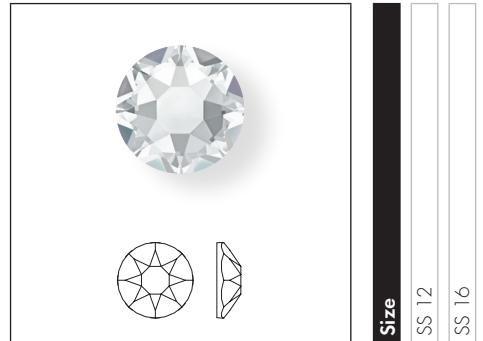

Size
SS 12
SS 16

Crystal

Crystal (001)

Colors

Plain Colors

- Amethyst (204)
- Aquamarine (202)
- Citrine (249)
- Fern Green (291)
- Fuchsia (502)
- Greige (284)
- Indian Siam (327)
- Jet (280)
- Light Peach (362)
- Light Rose (223)
- Montana (207)
- Peridot (214)
- Sapphire (206)
- Siam (208)
- Smoked Topaz (220)
- Tanzanite (539)
- Topaz (203)

Crystal Effects

Transparent Effects

- Crystal AB (001 AB)
- Crystal Golden Shadow (001 GSHA)
- Crystal Silver Night (001 SINI)
- Crystal Silver Shade (001 SSHA)

Metallic Effects

- Crystal Dorado (001 DOR)
- Crystal Light Chrome (001 LTCH)
- Crystal Metallic Light Gold (001 MIGLD)

Color Effects

Metallic Effects

- Jet Hemalite (280 HEM)

2300 Drop Flat Back



Size

8x4.8 mm

Crystal

Crystal (001)

Colors

Plain Colors

Jet (280)

Crystal Effects

Transparent Effects

Crystal AB (001 AB)

Crystal Golden Shadow (001 GSHA)

Color Effects

Metallic Effects

Jet Hematite (280 HEM)

2400 Square Flat Back

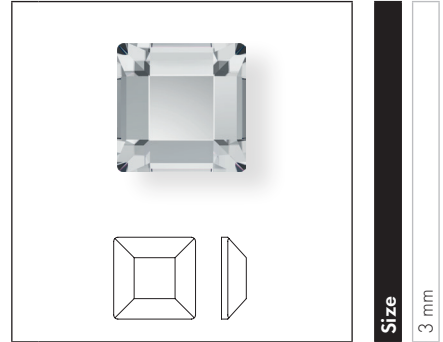

Size

3 mm

Crystal

Crystal (001)

Colors

Plain Colors

Jet (280)

Crystal Effects

Transparent Effects

Crystal AB (001 AB)

Crystal Golden Shadow (001 GSHA)

Metallic Effects

Crystal Light Chrome (001 LTCH)

Color Effects

Metallic Effects

Jet Hematite (280 HEM)

2510 Baguette Flat Back

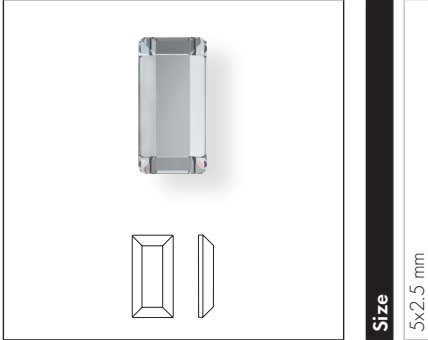

Size

5x2,5 mm

Crystal

Crystal (001)

Colors

Plain Colors

Jet (280)

Crystal Effects

Transparent Effects

Crystal AB (001 AB)

Color Effects

Metallic Effects

Jet Hematite (280 HEM)

2711 Triangle Flat Back

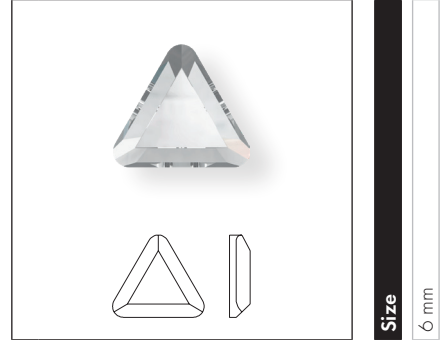

Size

6 mm

Crystal

Crystal (001)

Colors

Plain Colors

Jet (280)

Crystal Effects

Transparent Effects

Crystal AB (001 AB)

Metallic Effects

Crystal Light Chrome (001 LTCH)

Color Effects

Metallic Effects

Jet Hematite (280 HEM)

2728 Marguerite Flat Back

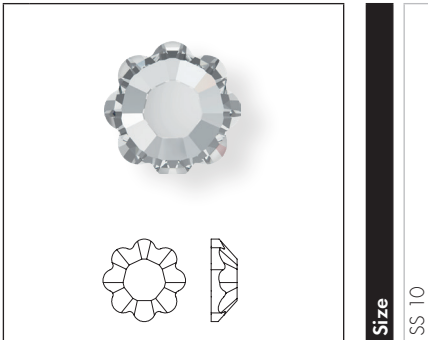

Size

SS 10

Crystal

Crystal (001)

Crystal Effects

Transparent Effects

Crystal AB (001 AB)

2817 Star Flat Back

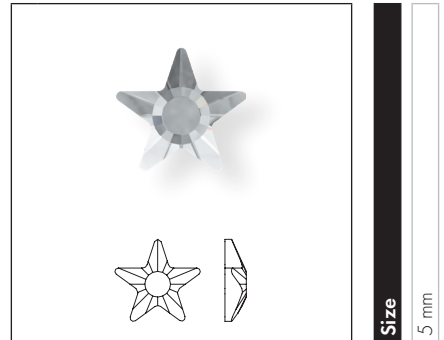

Size

5 mm

Crystal

Crystal (001)

Crystal Effects

Transparent Effects

Crystal AB (001 AB)

Crystal Golden Shadow (001 GSHA)

Crystal Silver Night (001 SINI)

STANDARD MOTIFS

75 500

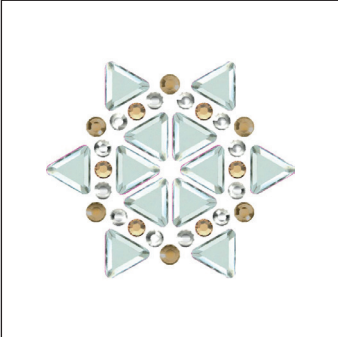

C 001LTCH/001GSHA/001MIGLD/001
E S8/S8/S10/CS6
S ~33x29 (TAPE : 75x53)
M 16 PCS **100%**

75 501

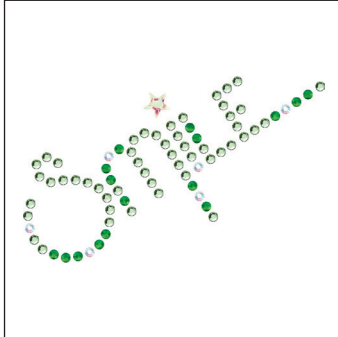

C 214/291/001AB/001AB
E S6/S6/S6/2817MM5
S ~60x37 (TAPE : 75x53)
M 16 PCS **66%**

75 502

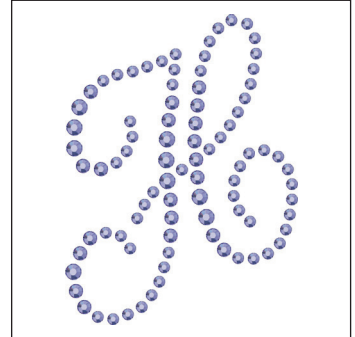

C 539/539/539
E S6/S8/S10
S ~51x38 (TAPE : 75x53)
M 16 PCS **80%**

75 503

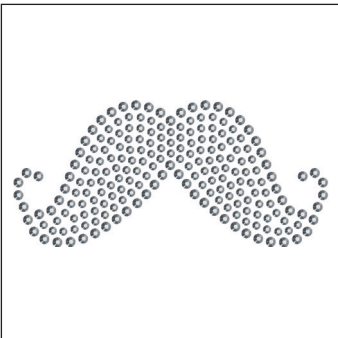

C 280HEM/280HEM
E S6/S8
S ~35x76 (TAPE : 75x105)
M 8 PCS **55%**

75 504

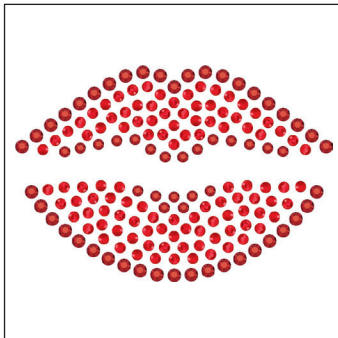

C 327/208/208
E S6/S6/S8
S ~55x38 (TAPE : 75x53)
M 16 PCS **76%**

75 505

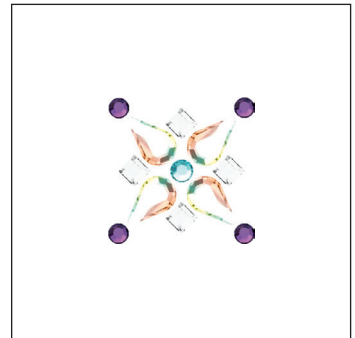

C 204/202/001AB/001
E S10/S12/CS8x5/CS3x3
S ~19x19 (TAPE : 38x53)
M 32 PCS **100%**

75 506

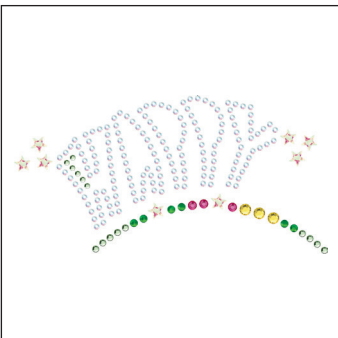

C 001AB/214/214/291/502/249/
001AB
E S6/S6/S8/S10/S12/S16T/
2817MM5
S ~103x52 (TAPE : 150x105)
M 4 PCS **40%**

75 507



C 001GSHA/001/001GSHA/
280HEM/001LTCH
E S6/S8/CS8x5/CS3x3/CS3x3
S ~57x34 (TAPE : 75x53)
M 200 PCS **71%**

75 508

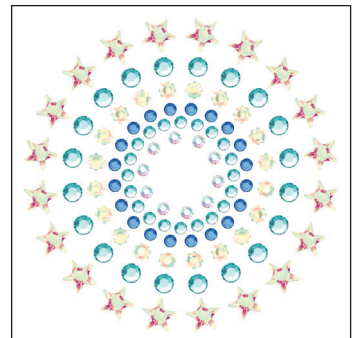

C 202/206/001AB/202/001AB/
001AB
E S6/S6/S6/S12/CB10/2817MM5
S ~48x48 (TAPE : 75x105)
M 8 PCS **86%**

75 509

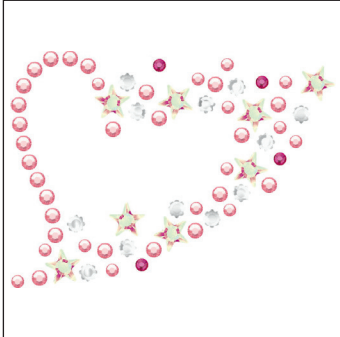

C 223/502/223/001/001AB
E S6/S6/S8/CB10/2817MM5
S ~49x36 (TAPE : 75x53)
M 16 PCS **88%**

75 510



C 280HEM/001/280HEM/001/
 280HEM/280/280/001LTCH/280
E S6/S6/S8/S10/CS6/CS8x5/
 CS3x3/CS5x2.5/2817MM5
S ~115x81 (TAPE : 150x105)
M 4 PCS **35%**

75 511

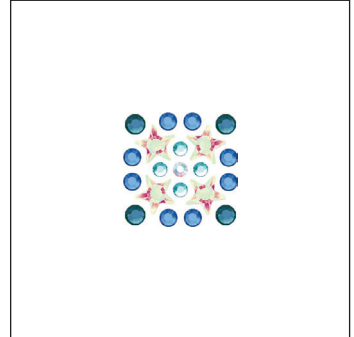

C 202/001AB/206/207/001AB
E S6/S6/S8/S10/2817MM5
S ~15x15 (TAPE : 38x53)
M 32 PCS **100%**

75 512

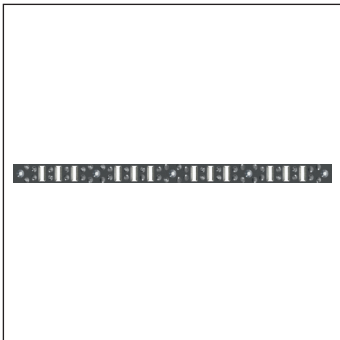

C 001SINI/280HEM/001LTCH
E S6/S10/CS5x2.5
S ~6x110 (TAPE : 43x210)
M 14 PCS **38%**

75 515

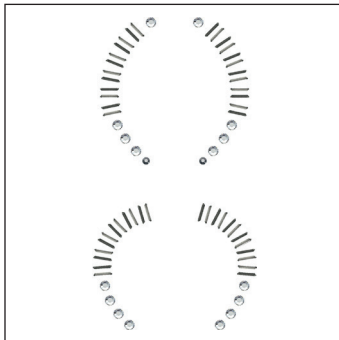

C 001/280HEM/001LTCH
E S6/S10/CS5x2.5
S ~43x82 (TAPE : 75x105)
M 16 PCS **50%**

SPECIAL MOTIF SERVICE

A special motif is any individual design created by the customer that differs to the Self-adhesive Elements Standard or Crystal Inspirations Collections. This service opens up an abundance of customization possibilities and enables you to profit from Swarovski's long-standing experience and design expertise. A range of customization options for existing motifs is also available

(see "Customization Possibilities" below). You can also submit design sketches that meet your special requirements, such as a brand image or an image for a particular sales campaign. This will then be made up according to your specifications using Computer Aided Design, which means that adjustments can be made easily according to your needs.

Customization Possibilities for Crystal-It Infinity

- Change of elements and colors of elements of an existing motif
- Change of size of an existing motif
- Logos or brand names
- Up to 9 different elements per motif are possible

Ordering Process

Send your request with the drawing you wish to order to your nearest Swarovski sales office. Make sure you include all measurements for the desired motif. Please also indicate which product group your special motif applies to (Crystal-it, Crystal Fabric-it, Crystaltex-it, Crystaltex-it Chaton, Crystal Fine Rocks-it).

You will then receive a quotation including your article number, minimum order quantity, price, and the line drawing of your special motif in PDF format. Please contact your Swarovski sales office again if any changes are required. Your special motif will be produced and delivered following your confirmation.

Please Note

Please always submit the drawing of your desired motif to represent it in the actual size you require. A small sketch, when enlarged to the desired size, will have blurred lines that will make it difficult to correctly reproduce. Pictures or drawings representing 100% size of the design or very good quality scans in JPG, BMP, or DXF format will ensure that we have clear data to work with. These can also be sent via email or on CD-ROM. If you are sending a sewing pattern, please include the whole pattern and not just sections. When the sketch is submitted as a hard copy by fax or email, please include a scale legend (e.g. copy/scan with a ruler next to the drawing). This will ensure that the desired size of the motif can be identified.

Special productions are generally offered to all our customers if these are deemed to be feasible and comply with our General Terms and Conditions. Please note that ordering a design does not grant exclusive production of this design to the customer.

If detailed information on potential tolerances is needed (e.g. cavity production for metal parts), please contact Swarovski who will enter an application request into our application database.