















Catalogue **SMART LIGHTING**
 Line **Lighting control by Nexta Tech**
 FAmily **Receivers**
 Subfamily **230V On-Off / Dimmer**
Download Nexta Tech catalogue [here.](#)

Picture	Article	Description	Lot	Price/Unit
 	15LOGIC400ONE		1	132,87 €
	Control unit LOGIC 400/ONE 6000W-230V	For the control of 4 lighting outputs. Remote control via AppOneSmart	10	126,54 €
		Length (mm): 140 Width (mm): 90 High (mm): 45 Voltage In (Vac): 230 Power (W): 6000 Room Temperature (°C): -20~+55 Ingress Protection: IP20		
		   		
	15MCUL1ONE		1	58,27 €
	Control Unit MCU-L1/ONE 1000W/110-240V	Remote control via AppOneSmart	10	46,77 €
		Length (mm): 52 Width (mm): 43 High (mm): 21 Voltage In (Vac): 110~240 Power (W): 250 Room Temperature (°C): -25~+55 Ingress Protection: IP20		
		   		

SMART LIGHTING > Lighting control by Nexta Tech > Receivers

Subfamily **230V On-Off / Dimmer**

Picture	Article	Description	Lot	Price/Unit
	15MCUL2		1	50,44 €
	Control Unit MCU-L2 2x500W/110-240V		10	43,42 €

Receiver control 2 device max 500W each with ON OFF and timed functionality.

Length (mm): 52 Width (mm): 43 High (mm): 21
Voltage In (Vac): 110~240 Power (W): 1000
Ingress Protection: IP20



	15TOPL1ONE		1	102,53 €
	Control unit TOP-L1/ONE 3000W 110-240V		10	97,64 €

Remote control via AppOneSmart



Length (mm): 174 Width (mm): 46 High (mm): 35
Voltage In (Vac): 110~240 Power (W): 3000
Room Temperature (°C): -20~+55
Ingress Protection: IP20







Catalogue **SMART LIGHTING**
Line **Lighting control by Nexta Tech**
FAMILY **Receivers**





Subfamily **Driver control 0-1/10V, dali, Push dim or phase cut**

Download Nexta Tech catalogue [here](#).





Picture	Article	Description	Lot	Price/Unit
	15MCU1224P		1	63,32 €
	Control unit MCU-1224P 12-24V	For dimmable drivers with PUSH. Normally open dry contact output max 1A. Length (mm): 52 Width (mm): 43 High (mm): 21 Voltage In (Vdc/ac): 12~24 Intensidad Out (A): 1 Room Temperature (°C): -20~+55 Ingress Protection: IP20	10	60,31 €
	15MCUDMONE		1	57,47 €
	Control unit MCU-DM/ONE 4-150W 110-240V	Remote control via AppOneSmart Length (mm): 52 Width (mm): 43 High (mm): 21 Voltage In (Vac): 110~240 Power (W): 4~150 Room Temperature (°C): -20~+55 Ingress Protection: IP20	10	54,73 €





Subfamily **Driver control 0-1/10V, dali, Push dim or phase cut**

Picture	Article	Description	Lot	Price/Unit
	15MCUPUSH		1	63,32 €
	Control unit Interface radio MCU-PUSH exit Push-Dim. 110-240V. 5A.		10	60,31 €
		Radio frequency interface for the control of Led drivers with "push dim" input Length (mm): 52 Width (mm): 43 High (mm): 21 Voltage In (Vac): 110~240 Intensidad In (A): 5 Room Temperature (°C): -20~+55 Ingress Protection: IP20		
		  		



	15TOP0110		1	86,68 €
	Control unit interface TOP-0110 for drivers 0-1/10V 2000W		10	82,55 €
		Receiver for RF regulation or cable of devices with input 0-1 / 10V max 2000W Length (mm): 174 Width (mm): 46 High (mm): 35 Voltage In (Vac): 110~240 Power (W): 2000 Room Temperature (°C): -20~+55 Ingress Protection: IP20		
		  		

Subfamily **Driver control 0-1/10V, dali, Push dim or phase cut**

Picture	Article	Description	Lot	Price/Unit
	15TOP0110ONE		1	100,40 €
	Control unit interface TOP-0110/ONE for drivers 0-1/10V 2000W		10	95,62 €
		For control of 0 / 1-10V Drivers		
		Length (mm): 176 Width (mm): 46 High (mm): 35 Voltage In (Vac): 110~230 Power (W): 2000 Room Temperature (°C): -20~+55 Ingress Protection: IP20		
				

	15TOPDL20		1	91,87 €
	Control unit interface TOP-DL20 for Drivers DALI		10	87,49 €
		Interphase receiver with dimmer function and DALI output for the control of up to 20 devices with DALI input. Power 110-240Vac. Departure BUS DALI		
		Length (mm): 174 Width (mm): 46 High (mm): 35 Voltage In (Vac): 110~240 Room Temperature (°C): -20~+55 Ingress Protection: IP20		
			 	

Subfamily **Driver control 0-1/10V, dali, Push dim or phase cut**

Picture	Article	Description	Lot	Price/Unit
	15WITOP1000		1	26,17 €
	Connection wire 10 m. RJ11 for TOP extender		10	24,92 €
		10-meter RJ11 connection cable with mounted connectors for the connection of the master control unit with the extension of the TOP series.		
		Length (mm): 10000		
				

	15WITOP30		1	13,10 €
	Connection wire 30 cm. RJ11 for TOP extender		10	12,48 €
		30 cm RJ11 connection cable with mounted connectors for the connection of the master control unit with the extension of the TOP series.		
		Length (mm): 300		
				

SMART LIGHTING > Lighting control by Nexta Tech > Receivers

Subfamily **Driver control 0-1/10V, dali, Push dim or phase cut**

Picture	Article	Description	Lot	Price/Unit
	15WITOP500		1	21,02 €
		Connection wire 5 m. RJ11 for TOP extender	10	20,02 €

5-meter RJ11 connection cable with mounted connectors for the connection of the master control panel with the extension of the TOP series.







Length (mm): 5000



Catalogue **SMART LIGHTING**
Line **Lighting control by Nexta Tech**
FAMILY **Receivers**

Subfamily **Constant current control, Dimmer, RGB**

Download Nexta Tech catalogue [here.](#)

Picture	Article	Description	Lot	Price/Unit
 	15TOPA03073	Control unit dimmer TOP-A0307/3 CC 350-700mA	1	97,66 €
		Intensity regulator for LED modules with constant current at 350mA or 700mA selectable with jumper. Low voltage power supply 12-24 or 36Vdc Length (mm): 174 Width (mm): 46 High (mm): 35 Voltage In (Vdc): 12~36 Ingress Protection: IP20	10	93,00 €
		  		
 	15TOPA0307RGB	Control unit dimmer TOP-A0307/RGB for led RGB CC 350-700mA	1	97,66 €
		Intensity regulator for RGB LED modules with constant current at 350mA or 700mA selectable with jumper. Low voltage power supply 12-24 or 36Vdc Length (mm): 174 Width (mm): 46 High (mm): 35 Voltage In (Vdc): 12~36 Room Temperature (°C): -20~+55 Ingress Protection: IP20	10	93,00 €
		  		



Subfamily **Constant current control, Dimmer, RGB**



Picture	Article	Description	Lot	Price/Unit
	15TOPA05093		1	97,66 €
	Control unit dimmer TOP-A0509/3 for led CC 500-900mA		10	93,00 €
		Intensity regulator for RGB LED modules with constant current at 500mA or 900mA selectable with jumper. Low voltage power supply 12-24 or 36Vdc Length (mm): 174 Width (mm): 46 High (mm): 35 Voltage In (Vdc): 12-36 Ingress Protection: IP20		
		  		

	15TOPA0509RGB		1	98,28 €
	Control unit dimmer TOP-A0509/RGB for led RGB CC 500-900mA		10	93,60 €
		Intensity regulator for RGB LED modules with constant current at 500mA or 900mA selectable with jumper. Low voltage power supply 12-24 or 36Vdc Length (mm): 174 Width (mm): 46 High (mm): 35 Voltage In (Vdc): 12-36 Ingress Protection: IP20		
		  		



SMART LIGHTING > Lighting control by Nexta Tech > Receivers



Subfamily **Constant current control, Dimmer, RGB**

Picture	Article	Description	Lot	Price/Unit
	15WITOP100		1	16,41 €
	Connection wire 1 m. RJ11 for TOP extender		10	15,63 €
		1 meter RJ11 connection cable with mounted connectors for the connection of the master control unit with the extension of the TOP series		
		Length (mm): 1000		
				

	15WITOP1000		1	26,17 €
	Connection wire 10 m. RJ11 for TOP extender		10	24,92 €
		10-meter RJ11 connection cable with mounted connectors for the connection of the master control unit with the extension of the TOP series.		
		Length (mm): 10000		
				

Subfamily **Constant current control, Dimmer, RGB**





Picture	Article	Description	Lot	Price/Unit
	15WITOP30		1	13,10 €
	Connection wire 30 cm. RJ11 for TOP extender		10	12,48 €
		30 cm RJ11 connection cable with mounted connectors for the connection of the master control unit with the extension of the TOP series.		
		Length (mm): 300		
				

	15WITOP500		1	21,02 €
	Connection wire 5 m. RJ11 for TOP extender		10	20,02 €
		5-meter RJ11 connection cable with mounted connectors for the connection of the master control panel with the extension of the TOP series.		
		Length (mm): 5000		
				

Catalogue **SMART LIGHTING**
Line **Lighting control by Nexta Tech**
FAMILY **Receivers**





Subfamily **Constant voltage control, Dimmer, RGBW, CCT, DTW**





Download Nexta Tech catalogue [here](#).

Picture	Article	Description	Lot	Price/Unit
	15MCUDMW	Control Unit dimmer MCU-DMW with function Dim to warm CV 12-24V.	1	66,99 €
		Intensity regulator for LEDs of constant tension to 12-24Vdc Max 4A with "Dim to warm" function Length (mm): 52 Width (mm): 43 High (mm): 21 Voltage In (Vdc/ac): 12~24 Ingress Protection: IP20	10	63,80 €
	15MCUV3RGB	Control Unit dimmer MCU-V3/RGB for led RGB CV 12-24V.	1	63,96 €
		Current regulator for RGB led at constant voltage 12-24Vdc max 2,5A per output. Length (mm): 52 Width (mm): 42 High (mm): 21 Voltage In (Vdc): 12~24 Ingress Protection: IP20	10	47,19 €

SMART LIGHTING > Lighting control by Nexta Tech > Receivers

Subfamily **Constant voltage control, Dimmer, RGBW, CCT, DTW**





Picture	Article	Description	Lot	Price/Unit
	15MCUV5		1	63,96 €
	Control Unit dimmer MCU-V5 for led monocolor CV 12-24V.		10	45,24 €
		Intensity regulator for leds at constant tension 12-24Vcc max 5A. With 1 cable entry		
		Length (mm): 52 Width (mm): 42 High (mm): 21 Voltage In (Vdc): 12~24 Ingress Protection: IP20		
		  		

	15MCUV5C		1	55,77 €
	Control Unit dimmer MCU-V5/C no radio for led monocolor CV 12-24V		10	52,91 €
		Intensity regulator for leds at constant tension 12-24Vcc max 5A. Control for 1 cable entry. Without RF		
		Length (mm): 52 Width (mm): 42 High (mm): 21 Voltage In (Vdc): 12~24 Ingress Protection: IP20		
		  		





SMART LIGHTING > Lighting control by Nexta Tech > Receivers





Subfamily **Constant voltage control, Dimmer, RGBW, CCT, DTW**

Picture	Article	Description	Lot	Price/Unit
	15PLANOMASTER		1	62,28 €
	PLANO-MASTER 12-24V DC LED		10	59,32 €
		Universal controller for led 12-24Vdc. Dimmer, RGB, RGBW, CCT		
		Length (mm): 80 Width (mm): 80 High (mm): 16 Voltage In (Vdc): 12~24 Room Temperature (°C): -20~+50 Ingress Protection: IP20		
				

	15PLANOONE		1	69,62 €
	PLANO-ONE 12-24V DC LED		10	66,30 €
		Universal controller for led 12-24Vdc. Dimmer, RGB, RGBW, CCT		
		Length (mm): 80 Width (mm): 80 High (mm): 16 Voltage In (Vdc): 12~24 Room Temperature (°C): -20~+50 Ingress Protection: IP20		
				





Subfamily **Constant voltage control, Dimmer, RGBW, CCT, DTW**





Picture	Article	Description	Lot	Price/Unit
	15PLANOV5		1	42,04 €
	PLANO-V5 1 channel dimmer receiver monochromatic CV 12-24V		10	40,04 €
		Length (mm): 80 Width (mm): 80 High (mm): 16 Voltage In (Vdc): 12~24 Intensidad In (A): 5 Power (W): 60~120 Room Temperature (°C): -20~+50 Ingress Protection: IP20		
			  	

	15PLANOV54BLE		1	70,66 €
	Control unit PLANO-V5/4BLE		10	67,29 €
		4xLed 12-24Vdc. Max 3A por salida. 36W a12V; 72W a 24V por cada salida. Max total 5A. 60W a 12V; 120W a 24V. Length (mm): 80 Width (mm): 80 High (mm): 16 Voltage In (Vdc): 12~24 Room Temperature (°C): -20~+55 Ingress Protection: IP20		
			 	





SMART LIGHTING > Lighting control by Nexta Tech > Receivers

Subfamily **Constant voltage control, Dimmer, RGBW, CCT, DTW**





Picture	Article	Description	Lot	Price/Unit
 	15PLANOV54CH		1	57,47 €
	PLANO-V5 4CH dimmer receiver 4 channels single color CV CV 12-24V		10	54,73 €
		Length (mm): 80 Width (mm): 80 High (mm): 16 Voltage In (Vdc): 12~24 Intensidad In (A): 5 Power (W): 60~120 Room Temperature (°C): -20~+50 Ingress Protection: IP20		
			 	

 	15PLANOV5RGBW		1	58,11 €
	PLANO-V5 RGBW dimmer receiver for RGB and RGBW CV 12-24V LED		10	45,24 €
		Length (mm): 80 Width (mm): 80 High (mm): 16 Voltage In (Vdc): 12~24 Intensidad In (A): 5 Power (W): 60~120 Room Temperature (°C): -20~+50 Ingress Protection: IP20		
			 	

Subfamily **Constant voltage control, Dimmer, RGBW, CCT, DTW**





Picture	Article	Description	Lot	Price/Unit
 	15PLANOV5RGBWBL	Control unit PLANO-V5 RGBW/BLE	1	70,66 €
		<p>Function: Mode 1: RGB. Mode 2: RGBW (W-W), Mode 3: RGBW (W-W + RGB)</p> <p>Length (mm): 80 Width (mm): 80 High (mm): 16 Voltage In (Vdc): 12~24 Room Temperature (°C): -20~+55 Ingress Protection: IP20</p>	10	67,29 €
 	15TOPV84	Control unit dimmer TOP-V8/4 for led monocolor CV 12-24-36V.	1	98,25 €
		<p>Dimmer for leds at constant voltage 12-24-36 Vdc 4 outputs max 8A per output (max 24A total) With 3 cable entries and input to extend</p> <p>Length (mm): 174 Width (mm): 46 High (mm): 35 Voltage In (Vdc): 12~36 Room Temperature (°C): -20~+55 Ingress Protection: IP20</p>	10	93,57 €



Subfamily **Constant voltage control, Dimmer, RGBW, CCT, DTW**

Picture	Article	Description	Lot	Price/Unit
	15TOPV8CCT2		1	107,12 €
	Control unit TOP-V8/CCT2 dimmer and Tcolor for led a CV 12-24-36V.		10	102,05 €
		<p>Dimmer for LEDs at constant voltage 12-24-36 Vdc with warm and cold LED. 4 outputs max 8A per output (max 24A total) With 3 cable entries and input to extend</p> <p>Length (mm): 174 Width (mm): 46 High (mm): 35 Voltage In (Vdc): 12~36 Room Temperature (°C): -20~+55 Ingress Protection: IP20</p>		
		<p>CE</p> <p> </p>		



	15TOPV8EXT4		1	68,25 €
	Control unit dimmer slave TOP-V8/EXT4 for led monocolor CV 12-24-36V.		10	65,00 €
		<p>Slave dimmer for led to constant tension compatible with master stations TOP-V8 / 4 monocolor</p> <p>Length (mm): 174 Width (mm): 46 High (mm): 35 Voltage In (Vdc): 12~24 Room Temperature (°C): -20~+55 Ingress Protection: IP20</p>		
		<p>CE</p> <p> </p>		

Subfamily **Constant voltage control, Dimmer, RGBW, CCT, DTW**

Picture	Article	Description	Lot	Price/Unit
	15TOPV8RGBW		1	98,25 €
	Control unit dimmer TOP-V8/RGBW for led RGB and RGBW CV 12-24-36V		10	93,57 €
		<p>Dimmer for LEDs with constant voltage 12-24-36 Vdc of RGB and RGBW LEDs. 4 outputs max 8A per output (max 24A total) With 3 cable entries and input to extend</p> <p>Length (mm): 174 Width (mm): 46 High (mm): 35 Voltage In (Vdc): 12~36 Room Temperature (°C): -20~+55 Ingress Protection: IP20</p>		
		  		

	15WITOP100		1	16,41 €
	Connection wire 1 m. RJ11 for TOP extender		10	15,63 €
		<p>1 meter RJ11 connection cable with mounted connectors for the connection of the master control unit with the extension of the TOP series</p> <p>Length (mm): 1000</p>		
				

Subfamily **Constant voltage control, Dimmer, RGBW, CCT, DTW**

Picture	Article	Description	Lot	Price/Unit
	15WITOP1000		1	26,17 €
	Connection wire 10 m. RJ11 for TOP extender		10	24,92 €
		10-meter RJ11 connection cable with mounted connectors for the connection of the master control unit with the extension of the TOP series.		
		Length (mm): 10000		
				

	15WITOP30		1	13,10 €
	Connection wire 30 cm. RJ11 for TOP extender		10	12,48 €
		30 cm RJ11 connection cable with mounted connectors for the connection of the master control unit with the extension of the TOP series.		
		Length (mm): 300		
				

SMART LIGHTING > Lighting control by Nexta Tech > Receivers

Subfamily **Constant voltage control, Dimmer, RGBW, CCT, DTW**

Picture	Article	Description	Lot	Price/Unit
	15WITOP500		1	21,02 €
		Connection wire 5 m. RJ11 for TOP extender	10	20,02 €





5-meter RJ11 connection cable with mounted connectors for the connection of the master control panel with the extension of the TOP series.

Length (mm): 5000





Catalogue **SMART LIGHTING**
Line **Lighting control by Nexta Tech**
FAMILY **Receivers**
Subfamily **Motors control**

Download Nexta Tech catalogue [here](#).





Picture	Article	Description	Lot	Price/Unit
 	15MCU1224		1	42,25 €
	Control unit MCU-1224 12-24Vdc/ac	Single-channel receiver with low voltage power 12-24Vdc / ac. Dry contact output normally open max 1A. Simple programming via dip-switch. Length (mm): 52 Width (mm): 43 High (mm): 21 Voltage In (Vdc/ac): 12~24 Intensidad Out (A): 1 Ingress Protection: IP20	10	40,17 €
 	15MCUM500		1	50,18 €
	Control Unit MCU-M500 for 1 motor max 500W	Receiver control by RF and cable of 1 motor with power 500W max Length (mm): 52 Width (mm): 43 High (mm): 21 Voltage In (Vac): 110~240 Power (W): 500 Ingress Protection: IP20	10	47,58 €





Catalogue **SMART LIGHTING**
 Line **Lighting control by Nexta Tech**
 Family **Transmitter**
 Subfamily **OPTIMA**
 Radiotransmitters Wireless Wall Switches with Battery or mains

Picture	Article	Description	Lot	Price/Unit
	15OPT1C	Radiotransmitter wall switch OPT-1C RGB/RGBW battery CR2451	1	45,25 €
		1 channel. Funtions: ON-OFF Length (mm): 85 Width (mm): 85 High (mm): 12	10	43,10 €
	15OPT1CCT	Radiotransmitter wall switch OPT-1CCT battery CR2451	1	45,25 €
		1 channel. Funtions: ON-OFF Length (mm): 85 Width (mm): 85 High (mm): 12	10	43,10 €

SMART LIGHTING > Lighting control by Nexta Tech > Transmitter





Subfamily **OPTIMA**





Picture	Article	Description	Lot	Price/Unit
	15OPT1CCTPW		1	62,28 €
	Radiotransmitter wall switch OPT-1CCT/PW 230Vac		10	59,32 €
		1 channel. Funtions: ON-OFF Length (mm): 85 Width (mm): 85 High (mm): 12 Voltage In (Vac): 230		
				

	15OPT1CPW		1	62,28 €
	Radiotransmitter wall switch OPT-1C/PW RGB/RGBW 230Vac		10	59,32 €
		1 channel. Funtions: ON-OFF Length (mm): 85 Width (mm): 85 High (mm): 12 Voltage In (Vac): 230		
				

SMART LIGHTING > Lighting control by Nexta Tech > Transmitter



Subfamily **OPTIMA**



Picture	Article	Description	Lot	Price/Unit
	15OPT1DIM		1	45,25 €
	Radiotransmitter wall switch OPT-1DIM battery CR245		10	43,10 €
		1 channel. Funtions: ON-OFF Length (mm): 85 Width (mm): 85 High (mm): 12		
		CE 		

	15OPT1DIMPW		1	62,28 €
	Radiotransmitter wall switch OPT-1DIM/PW 230Vac		10	59,32 €
		1 channel. Funtions: ON-OFF Length (mm): 85 Width (mm): 85 High (mm): 12 Voltage In (Vac): 230		
		CE 		

SMART LIGHTING > Lighting control by Nexta Tech > Transmitter





Subfamily **OPTIMA**





Picture	Article	Description	Lot	Price/Unit
	15OPT2G		1	39,25 €
	Radiotransmitter wall switch OPT-2G battery CR2450		10	37,38 €
	2 buttons with selectable function	Length (mm): 85 Width (mm): 85 High (mm): 12		
	CE			

	15OPT2GPW		1	56,52 €
	Radiotransmitter wall switch OPT-2G/PW 230Vac		10	53,83 €
	2 buttons with selectable function	Length (mm): 85 Width (mm): 85 High (mm): 12 Voltage In (Vac): 230		
	CE			

SMART LIGHTING > Lighting control by Nexta Tech > Transmitter





Subfamily **OPTIMA**





Picture	Article	Description	Lot	Price/Unit
	15OPT4DIM		1	51,84 €
	Radiotransmitter wall switch OPT-4DIM battery CR245		10	49,37 €
		4 channels. Funtions: ON-OFF		
		Length (mm): 85 Width (mm): 85 High (mm): 12		
				

	15OPT4DIMPW		1	68,84 €
	Radiotransmitter wall switch OPT-4DIM/PW 230Vac		10	65,56 €
		4 channels. Funtions: ON-OFF		
		Length (mm): 85 Width (mm): 85 High (mm): 12 Voltage In (Vac): 230		
				





SMART LIGHTING > Lighting control by Nexta Tech > Transmitter



Subfamily **OPTIMA**

Picture	Article	Description	Lot	Price/Unit
	15OPT4G		1	45,25 €
	Radiotransmitter wall switch OPT-4G battery CR2450		10	43,10 €
		4 buttons with selectable function		
		Length (mm): 85 Width (mm): 85 High (mm): 12		
				

	15OPT4GPW		1	62,47 €
	Radiotransmitter wall switch OPT-4G/PW 230Vac		10	59,49 €
		4 buttons with selectable function		
		Length (mm): 85 Width (mm): 85 High (mm): 12 Voltage In (Vac): 230		
				









Subfamily **OPTIMA**

Picture	Article	Description	Lot	Price/Unit
	15OPT8G		1	51,84 €
	Radiotransmitter wall switch OPT-8G battery CR2450		10	49,37 €
	8 buttons with selectable function Length (mm): 85 Width (mm): 85 High (mm): 12			
				
		 		

	15OPT8GPW		1	69,04 €
	Radiotransmitter wall switch OPT-8G/PW 230Vac		10	65,75 €
	8 buttons with selectable function Length (mm): 85 Width (mm): 85 High (mm): 12 Voltage In (Vac): 230			
				
		 		









Catalogue **SMART LIGHTING**
Line **Lighting control by Nexta Tech**
Family **Transmitter**
Subfamily **HOBLO80**

Download Nexta Tech catalogue [here](#).









Picture	Article	Description	Lot	Price/Unit
 	15HB801C	Remote control HB80-1C for 1 channel RGBW or tunable CCT	1 10	43,13 € 41,08 €
		<p>Radio transmitter 1 channel, On-Off function, dimmer up / down, color control RGB / RGBW and CCT, dynamic cycle control. CR2450 battery. Wall magnetic support.</p> <p>High (mm): 13 Diameter (mm): 80 Voltage In (Vdc): 3</p>		
		 		
 	15HB801DIM	Remote control HB80-1DIM for 1 monochromatic channel	1 10	43,13 € 41,08 €
		<p>Radio transmitter 1 channel. Monocolor On-Off function, dimer up / down. With CR2450 battery, magnetic wall bracket.</p> <p>High (mm): 13 Diameter (mm): 80 Voltage In (Vdc): 3</p>		
		 		

SMART LIGHTING > Lighting control by Nexta Tech > Transmitter

Subfamily **HOBLO80**





Picture	Article	Description	Lot	Price/Unit
	15HB802L		1	43,33 €
	Remote control HB80-2L 2 channels.		10	41,26 €
		Radio transmitter 2 channels. Function On-Off, dimmer up / down, open-close-stop (motors). CR2450 battery. Wall magnetic support. Black color		
		High (mm): 13 Diameter (mm): 80 Colour: Black Voltage In (Vdc): 3		
				
	15HB8030D		1	47,05 €
	Remote control HB80-30D 30 channels and 4 groups		10	44,81 €
		Radio transmitter 30 channels and 4 groups. Function On-Off, dimmer up / down, Open-close-stop (motors). CR2450 battery. Wall magnetic support.		
		High (mm): 13 Diameter (mm): 80 Voltage In (Vdc): 3		
				





Subfamily **HOBLO80**

Picture	Article	Description	Lot	Price/Unit
	15HB8030RGBW		1	47,05 €
	Remote control HB80-30RGBW 30 Channels RGBW and CCT	Radio transmitter 30 channels. On-Off function, dimmer up / down, color control RGB / RGBW and CCT, dynamic cycle control. Open-close-stop (motors). CR2450 battery. Wall magnetic support.	10	44,81 €
		High (mm): 13 Diameter (mm): 80 Voltage In (Vdc): 3		
				
	15HB804C		1	45,27 €
	Remote control HB80-4C 4 channels RGBW or CCT white	Radio transmitter 4 channels + All. On-Off function, dimmer up / down, color control RGB / RGBW and CCT, dynamic cycle control. CR2450 battery. Wall magnetic support.	10	43,11 €
		High (mm): 13 Diameter (mm): 80 Voltage In (Vdc): 3		
				

SMART LIGHTING > Lighting control by Nexta Tech > Transmitter





Subfamily **HOBLO80**

Picture	Article	Description	Lot	Price/Unit
	15HB804DIM		1	45,27 €
	Remote control HB80-4DIM 4 channels monocolor		10	43,11 €
		Radio transmitter 4 channels + All. Monocolor Function On-Off, dimmer up / down. With CR2450 battery, magnetic wall bracket.		
		High (mm): 13 Diameter (mm): 80 Voltage In (Vdc): 3		
				

	15HB804L		1	43,33 €
	Remote control HB80-4L 4 channels .		10	41,26 €
		Radio transmitter 4 channels + All. Function On-Off, dimmer up / down, open-close-stop (motors). CR2450 battery. Wall magnetic support.		
		High (mm): 13 Diameter (mm): 80 Voltage In (Vdc): 3		
				





SMART LIGHTING > Lighting control by Nexta Tech > Transmitter

Subfamily **HOBLO80**

Picture	Article	Description	Lot	Price/Unit
	15HB806G		1	43,33 €
	Remote control HB80-6G 6 Channels with settable function		10	41,26 €
		Radio transmitter with 6 buttons with configurable functions. CR2450 battery. Wall magnetic support.		
		High (mm): 13 Diameter (mm): 80 Voltage In (Vdc): 3		
				









Catalogue **SMART LIGHTING**
 Line **Lighting control by Nexta Tech**
 Family **Transmitter**
 Subfamily **HOBLO90**

Download Nexta Tech catalogue [here.](#)

Picture	Article	Description	Lot	Price/Unit
	15HB906LT		1	110,14 €
	Remote control HB90-6LT 6 Channels	Radio transmitter with 6 channels with configurable functions for the control of dimmable lights, CCT or RGB / W. High (mm): 30 Diameter (mm): 90 Voltage In (Vdc): 3	10	104,90 €
				



Catalogue **SMART LIGHTING**
Line **Lighting control by Nexta Tech**
FAMILY **Transmitter**
Subfamily **Touch**



Download Nexta Tech catalogue [here.](#)

Picture	Article	Description	Lot	Price/Unit
	15ROUND1G		1	28,73 €
	Radio transmitter ROUND-1G		10	27,37 €
		<p>Radio transmitter a channel with configurable functions. Recessed fixing with hole diameter 35mm and 13mm depth. With CR2450 battery included for 3 years of half life.</p> <p>High (mm): 14 Diameter (mm): 38 Voltage In (Vdc): 3 Ingress Protection: IP20</p>		
				
	15TOUCH1		1	31,54 €
	Remote control TOUCH-1		10	30,03 €
		<p>Radio transmitter 1 channel with On / Off- Dimmer function. CR2450 battery included for 3 years average life</p> <p>Length (mm): 40 Width (mm): 40 High (mm): 10 Voltage In (Vdc): 3</p>		
				



SMART LIGHTING > Lighting control by Nexta Tech > Transmitter

Subfamily **Touch**

Picture	Article	Description	Lot	Price/Unit
	15TOUCH1C		1	31,54 €
	Remote control TOUCH-1C	Radio transmitter 1 channel. Functions On / Off, dimmer, play / stop cycle, change color + white. Ideal for Led CCT and RGB / W strips	10	30,03 €
		Length (mm): 40 Width (mm): 40 High (mm): 10 Voltage In (Vdc): 3		
	CE			

	15TOUCH1CCT		1	31,54 €
	Remote control TOUCH-1CCT	Radio transmitter 1 channel. Function On-Off, dimmer color temperature selection with tactile crown. CR2450 battery included for 3 years average life	10	30,03 €
		Length (mm): 40 Width (mm): 40 High (mm): 10 Voltage In (Vdc): 3		
	CE			

Subfamily **Touch**

Picture	Article	Description	Lot	Price/Unit
	15TOUCH1DIM		1	24,57 €
	Remote control TOUCH-1DIM		10	23,40 €
	15TOUCH1G		1	22,53 €
	Remote control TOUCH-1G		10	21,45 €



Radio transmitter 1 channel. On-Off function, dimmer with tactile crown. CR2450 battery included for 3 years average life

Length (mm): 40 Width (mm): 40 High (mm): 10
Voltage In (Vdc): 3



Radio transmitter 1 button with configurable function. CR2450 battery included for 3 years average life

Length (mm): 40 Width (mm): 40 High (mm): 10
Voltage In (Vdc): 3





Subfamily **Touch**



Picture	Article	Description	Lot	Price/Unit
	15TOUCH1L		1	31,54 €
	Remote control TOUCH-1L		10	30,03 €
		<p>Radio transmitter 1 channel. Function On-Off, dimmer up / down, open-close-stop (motors). CR2450 battery included for 3 years average life</p> <p>Length (mm): 40 Width (mm): 40 High (mm): 10 Voltage In (Vdc): 3</p>		
		 		

	15TOUCH1RGBW		1	24,57 €
	Remote control TOUCH-1RGBW		10	23,40 €
		<p>Radio transmitter 1 channel. Function On-Off, dimmer color selection with tactile crown. CR2450 battery included for 3 years average life</p> <p>Length (mm): 40 Width (mm): 40 High (mm): 10 Voltage In (Vdc): 3</p>		
		 		





SMART LIGHTING > Lighting control by Nexta Tech > Transmitter





Subfamily **Touch**

Picture	Article	Description	Lot	Price/Unit
	15TOUCH2G		1	24,57 €
	Remote control TOUCH-2G		10	23,40 €
		Radio transmitter 2 buttons with configurable functions. CR2450 battery included for 3 years average life		
		Length (mm): 40 Width (mm): 40 High (mm): 10 Voltage In (Vdc): 3		
		CE		





	15TOUCH3C		1	38,14 €
	Remote control TOUCH-3C		10	36,32 €
		Radio transmitter 3 channels with On-Off function, dimmer and color selection for CCT and RGB / W with tactile crown. CR2450 battery included for 3 years average life		
		Length (mm): 40 Width (mm): 40 High (mm): 10 Voltage In (Vdc): 3		
		CE		

Subfamily **Touch**

Picture	Article	Description	Lot	Price/Unit
	15TOUCH4DIM		1	24,60 €
	Remote control TOUCH-4DIM		10	23,43 €
		Radio transmitter 4 channels. On-Off function, dimmer. CR2450 battery included for 3 years average life		
		Length (mm): 40 Width (mm): 40 High (mm): 10 Voltage In (Vdc): 3		
		 		

	15TOUCH4G		1	24,57 €
	Remote control TOUCH-4G		10	23,40 €
		Radio transmitter 4 buttons with configurable functions. Bateria CR2450 included for average life of 3 years		
		Length (mm): 40 Width (mm): 40 High (mm): 10 Voltage In (Vdc): 3		
		 		

Subfamily **Touch**

Picture	Article	Description	Lot	Price/Unit
	15TOUCHCFU		1	31,54 €
	Remote control TOUCH-CFU		10	30,03 €
		<p>Radio transmitter 1 channel. To be used with TOUCH-1RGBW. Function play / stop cycle, cycle speed change. Change cycle effect, color memo. CR2450 battery included for 3 years average life</p> <p>Length (mm): 40 Width (mm): 40 High (mm): 10 Voltage In (Vdc): 3</p>		
	15TOUCHLOCK4		1	31,72 €
	Remote control TOUCH-LOCK4		10	22,62 €
		<p>Radio transmitter 4 buttons with configurable functions. Lock function to avoid accidental pulsations. CR2450 material included for 3-year half-life</p> <p>Length (mm): 40 Width (mm): 40 High (mm): 10 Voltage In (Vdc): 3</p>		

SMART LIGHTING > Lighting control by Nexta Tech > Transmitter

Subfamily **Touch**









Picture	Article	Description	Lot	Price/Unit
	15TOUCHTX2		1	31,46 €
	Remote control TOUCH-TX2		10	29,97 €

Radio transmitter to transform standard wired push buttons into radio transmitters. 2 channels with configurable functions. CR2450 battery included for 3 years average life









Length (mm): 40 Width (mm): 40 High (mm): 10
Voltage In (Vdc): 3



Catalogue **SMART LIGHTING**
 Line **Lighting control by Nexta Tech**
 Family **Transmitter**
 Subfamily **TX and repeaters**
Download Nexta Tech catalogue [here.](#)





Picture	Article	Description	Lot	Price/Unit
	15MCURR		1	56,54 €
	Radio repeater MCU-RR 110-240V	Radio repeater to increase the signal range	10	53,85 €
		Length (mm): 52 Width (mm): 42 High (mm): 21 Voltage In (Vac): 110~240 Ingress Protection: IP20		
				
	15MCUTX4		1	42,08 €
	Radio transmitter MCU-TX4 110-240Vac or battery CR2032.	Recessed transmitter for transforming wall push buttons in radio frequency transmitters. Power supply or CR2032 battery	10	40,08 €
		Length (mm): 52 Width (mm): 42 High (mm): 21 Voltage In (Vac): 110~240 Ingress Protection: IP20		
				

Catalogue **SMART LIGHTING**
 Line **Lighting control by Nexta Tech**
 FAmily **Sensors**
 Subfamily **Motion and luminosity sensors**
Download Nexta Tech catalogue [here.](#)

Picture	Article	Description	Lot	Price/Unit
	15ROUND1SP		1	47,33 €
	Motion sensor ROUND-1SP	<p>Motion sensor with integrated brightness sensor. To embed in holes of 35x12mm. Double function, sensor / radio transmitter. Configurable detection distance. CR2450 battery included</p> <p>High (mm): 12 Diameter (mm): 38 Voltage In (Vdc): 3</p>	10	45,08 €
				
	15TOUCH1SP		1	44,72 €
	Sensor de movimiento TOUCH-1SP	<p>Motion sensor with integrated brightness sensor. Double function, sensor / radio transmitter. Configurable detection distance. CR2450 battery included for 3 years average life</p> <p>Length (mm): 40 Width (mm): 40 High (mm): 10</p>	10	42,59 €
				

Catalogue **SMART LIGHTING**
 Line **Lighting control by Nexta Tech**
 Family **Sensors**
 Subfamily **Furniture sensors**

Download Nexta Tech catalogue [here.](#)

Picture	Article	Description	Lot	Price/Unit
 	15MAG1030D		1	39,20 €
	Magnetic D10x H30mm. Kit 10 units	Magnet with diametral load of 10mm diameter and 30mm height to be used with SENSE-M and SENSE-35RM High (mm): 30 Diameter (mm): 10	10	37,32 €
 	15MAG153A		1	10,52 €
	Magnetic D15x H3mm. Kit 10 units	Magnet with axial load of 15mm diameter and 2mm height to be used with SENSE-M and SENSE-35RM. High (mm): 3 Diameter (mm): 15	10	10,01 €

Subfamily **Furniture sensors**

Picture	Article	Description	Lot	Price/Unit
	15MAG225A		1	19,66 €
	Magnetic D22x H5mm. Kit 10 units		10	18,72 €

Magnet with axial load of 22mm diameter and 5mm height to be used with SENSE-M and SENSE-35RM

High (mm): 5 Diameter (mm): 22











	15MCUSEN4		1	58,11 €
	Control Unit MCU-SEN4 4 exits 12-24Vdc		10	55,12 €
	Intensity regulator for LEDs of constant tension at 12-24Vdc. 4 outputs 2.5A per output		30	52,39 €

Intensity regulator for LEDs of constant tension at 12-24Vdc. 4 outputs 2.5A per output



Length (mm): 52 Width (mm): 42 High (mm): 21
Voltage In (Vdc): 12-24 Ingress Protection: IP20



Subfamily **Furniture sensors**

Picture	Article	Description	Lot	Price/Unit
	15SENSAM		1	28,74 €
	Motion sensor SENSAM-M		10	27,38 €
		<p>Motion sensor for furniture. It allows the timed ignition of the light and the shutdown with magnetic contact closure.</p> <p>Length (mm): 64,8 Width (mm): 38,8 High (mm): 9,8 Voltage In (Vdc): 3</p>		
				
	15SENSAP		1	35,62 €
	Motion sensor SENSAP-P		10	33,80 €
		<p>Motion sensor for furniture. It allows the timed ignition of the light and the closing shutdown by recognition of the position of the door.</p> <p>Length (mm): 64,8 Width (mm): 38,8 High (mm): 9,8 Voltage In (Vdc): 3</p>		
				

Subfamily **Furniture sensors**

Picture	Article	Description	Lot	Price/Unit
	15SENSAR35M		1	28,74 €
	Motion sensor SENSEA-35RM	Recessed motion sensor for furniture in holes D35mm H 12mm. It allows the timed ignition of the light and the shutdown with magnetic contact closure.	10	27,38 €
		Diameter (mm): 38 Voltage In (Vdc): 3		
				
	15SENSAR35T		1	24,99 €
	Motion sensor SENSEA-35RT	Recessed motion sensor for furniture in holes D35mm H 12mm. It allows the timed lighting of the light. The timer is activated for the time the user moves the door.	10	23,79 €
		Diameter (mm): 38 Voltage In (Vdc): 3		
				

SMART LIGHTING > Lighting control by Nexta Tech > Sensors

Subfamily **Furniture sensors**

Picture	Article	Description	Lot	Price/Unit
	15SENSAT		1	24,99 €
	Motion sensor SENSAT-T		10	23,79 €

Motion sensor for furniture. It allows the timed lighting of the light. The timer is activated so that the user moves the door

Length (mm): 64,8 Width (mm): 38,8 High (mm): 9,8
Voltage In (Vdc): 3



Catalogue **SMART LIGHTING**
 Line **Lighting control by Nexta Tech**
 FAmily **Extrasonic**
 Subfamily **Extrasonic**

Picture	Article	Description	Lot	Price/Unit
	15PLUG1220		1	29,43 €
	Plug led power supply 12Vdc 20W		10	28,03 €
	Plug-in power supply 230Vac 12Vdc 20W			



	15PS1220		1	14,38 €
	Led power supply 12Vdc 20W		10	13,69 €
	Power supply 230vac12Vdc			
	Length (mm): 130 Width (mm): 56 High (mm): 15			
	Power (W): 20			



SMART LIGHTING > Lighting control by Nexta Tech > Extrasonic









Subfamily **Extrasonic**

Picture	Article	Description	Lot	Price/Unit
	15SONIC100		1	124,20 €
	Sound system SONIC 100		10	118,29 €
	Sound system composed of 1 Bluetooth Amplifier 15W-12Vdc			





Length (mm): 157 Width (mm): 115 High (mm): 28
Voltage In (Vdc): 12 Power (W): 15



Catalogue **SMART LIGHTING**
 Line **Lighting control by Nexta Tech**
 Family **Control Pergolas and awnings**
 Subfamily **Pergola Roof control**





Picture	Article	Description	Lot	Price/Unit
	15PRGM24	Control box PRG-M24 pergola adjustable slat motors	1	141,96 €
		Length (mm): 310 Width (mm): 70 High (mm): 80 Voltage In (Vdc): 24 Room Temperature (°C): -20~+55 Ingress Protection: IP55		
		 		
	15PRGM24ONE	Control box PRG-M24/One pergola adjustable slat motors	1	169,26 €
		Length (mm): 310 Width (mm): 70 High (mm): 80 Voltage In (Vdc): 24 Room Temperature (°C): -20~+55 Ingress Protection: IP55		
		 		

Subfamily **Pergola Roof control**

Picture	Article	Description	Lot	Price/Unit
	15PRGML24	Control box PRG-ML24 lights and motors adjustable slats pergola	1	174,28 €
		Length (mm): 310 Width (mm): 70 High (mm): 80 Voltage In (Vdc): 24 Room Temperature (°C): -20~+55 Ingress Protection: IP55	 	









	15PRGML24ONE	Control box PRG-ML24/One lights and motors adjustable slats pergola	1	199,17 €
		Length (mm): 310 Width (mm): 70 High (mm): 80 Voltage In (Vdc): 24 Room Temperature (°C): -20~+55 Ingress Protection: IP55	 	

Subfamily Pergola Roof control





Picture	Article	Description	Lot	Price/Unit
	15SCREENML	Control box SCREEN-ML Lights and pergola tubular motor	1	137,23 €
		Length (mm): 310 Width (mm): 70 High (mm): 80 Voltage In (Vac): 230 Room Temperature (°C): -20~+55 Ingress Protection: IP55	 	

	15SCREENMLONE	SCREEN-ML/ONE control box Lights and pergola tubular motor	1	163,62 €
		Length (mm): 310 Width (mm): 70 High (mm): 80 Voltage In (Vac): 230 Room Temperature (°C): -20~+55 Ingress Protection: IP55	 	





Catalogue **SMART LIGHTING**
 Line **Lighting control by Nexta Tech**
 Family **Control Pergolas and awnings**
 Subfamily **Pergola Awning control**

Picture	Article	Description	Lot	Price/Unit
 	15SCREENM400	SCREEN-M400 control box 4 pergola tubular motors	1	112,03 €
		Length (mm): 310 Width (mm): 70 High (mm): 80 Voltage In (Vac): 230 Room Temperature (°C): -20~+55 Ingress Protection: IP55		
		 		
 	15SCREENM400ONE	Control box SCREEN-M400/ONE 4 pergola tubular motors	1	145,15 €
		Length (mm): 310 Width (mm): 70 High (mm): 80 Voltage In (Vac): 230 Room Temperature (°C): -20~+55 Ingress Protection: IP55		
		 		

Catalogue **SMART LIGHTING**
 Line **Lighting control by Nexta Tech**
 Family **Control Pergolas and awnings**
 Subfamily **Pergola Lighting control**

Picture	Article	Description	Lot	Price/Unit
 	15LB100ONE Led Box IP55 24V LB-100/ONE	Length (mm): 310 Width (mm): 70 High (mm): 80 Voltage In (Vac): 230 Voltage Out (Vdc): 24 Power (W): 100 Room Temperature (°C): -20~+55 Ingress Protection: IP55	1	138,58 €
 	15LB150ONE Led Box LB-150/One	Length (mm): 310 Width (mm): 70 High (mm): 80 Voltage In (Vac): 230 Voltage Out (Vdc): 24 Power (W): 150 Room Temperature (°C): -20~+55 Ingress Protection: IP55	1	151,75 €

Subfamily Pergola Lighting control

Picture	Article	Description	Lot	Price/Unit
 	15LB50ONE	Led Box IP55 24V LB-50/ONE	1	118,82 €
		Length (mm): 310 Width (mm): 70 High (mm): 80 Voltage In (Vac): 230 Voltage Out (Vdc): 24 Power (W): 50 Room Temperature (°C): -20~+55 Ingress Protection: IP55		
		 		

 	15LBDIM100ONE	Led Box LB-DIM100/One	1	138,55 €
		Length (mm): 310 Width (mm): 70 High (mm): 80 Voltage In (Vac): 230 Voltage Out (Vdc): 24 Power (W): 100 Room Temperature (°C): -20~+55 Ingress Protection: IP55		
		 		

Catalogue **SMART LIGHTING**
 Line **Lighting control by Nexta Tech**
 Family **Control Pergolas and awnings**
 Subfamily **Multi-funtion remote control**

Picture	Article	Description	Lot	Price/Unit
	15LINEA4R LINEA-4R radio transmitter	Dark gray Length (mm): 36 Width (mm): 71 High (mm): 8 Colour: Grey	1	17,52 €
				
	15LINEA4RW LINEA-4R/W radio transmitter	White Length (mm): 36 Width (mm): 71 High (mm): 8 Colour: White	1	17,52 €
				

Catalogue **SMART LIGHTING**
 Line **Lighting control by Nexta Tech**
 Family **Control Pergolas and awnings**
 Subfamily **Pergola Weather sensors**

Picture	Article	Description	Lot	Price/Unit
	15MTR	Rain Weather Sensor MT-R	1	87,09 €



	15MTWS	Meteo wind and light sensor MT-WS	1	51,47 €
--	--------	-----------------------------------	---	---------



Catalogue **SMART LIGHTING**
Line **Lighting control by Nexta Tech**
Family **Control Pergolas and awnings**
Subfamily **Pergola Wi-Fi video control**











Picture	Article	Description	Lot	Price/Unit
	15CAM200		1	112,03 €

Video camera Smart Cam200





Voltage In (Vdc): 5 Intensidad In (A): 1
Ingress Protection: IP66



Catalogue **SMART LIGHTING**
 Line **Lighting control by Nexta Tech**
 FAmily **Control Pergolas and awnings**
 Subfamily **Pergola accessories**





Picture	Article	Description	Lot	Price/Unit
	15EP1000MF	Wiring EP-1000/MF 1000mm male-female connectors	1	3,30 €
		Cable length 1000 mm with Easy-Plug Male-Female connector		
		Length (mm): 10000 Colour: Black Ingress Protection: IP65		
	  			
	15EP150F	Wiring EP-150/F 150mm 1 female connector	1	1,98 €
		Cable length 150 mm with Easy-Plug Male-Female connector		
		Length (mm): 150 Colour: Black Ingress Protection: IP65		
	  			





Subfamily Pergola accessories

Picture	Article	Description	Lot	Price/Unit
	15EP150M	Wiring EP-150/M 150mm 1 male connector	1	1,98 €
		Cable length 150 mm with Easy-Plug Male-Female connector		
		Length (mm): 150 Colour: Black Ingress Protection: IP65		
		 		









	15EP150M2F	Wiring EP-150/M2F 150mm 1 male connector and 2 female connectors	1	5,94 €
		3-way cable. Length 150 mm with 1 male connector and 2 Easy-Plug female connectors		
		Length (mm): 150 Colour: Black Ingress Protection: IP65		
		 		

Subfamily Pergola accessories

Picture	Article	Description	Lot	Price/Unit
	15EP2000MF	Wiring EP-1000/MF 2000mm male-female connectors Cable length 2000 mm with Easy-Plug Male-Female connector Length (mm): 20000 Colour: Black Ingress Protection: IP65	1	6,31 €
		 		

	15LB50PS	230Vac-24Vdc 50W power supply waterproof plastic box IP55 LB-50/PS Length (mm): 310 Width (mm): 70 High (mm): 80 Voltage In (Vac): 230 Voltage Out (Vdc): 24 Power (W): 50 Room Temperature (°C): -20~+55 Ingress Protection: IP55	1	58,06 €
		 		

Subfamily Pergola accessories

Picture	Article	Description	Lot	Price/Unit
	15LB100PS	230Vac-24Vdc 100W power supply waterproof plastic box IP55 LB-100/PS Length (mm): 310 Width (mm): 70 High (mm): 80 Voltage In (Vac): 230 Voltage Out (Vdc): 24 Power (W): 100 Room Temperature (°C): -20~+55 Ingress Protection: IP55	1	72,58 €
		CE  		
	15LB150PS	230Vac-24Vdc 150W power supply waterproof plastic box IP55 LB-150/PS Length (mm): 310 Width (mm): 70 High (mm): 80 Voltage In (Vac): 230 Voltage Out (Vdc): 24 Power (W): 150 Room Temperature (°C): -20~+55 Ingress Protection: IP55	1	85,77 €
		CE  		
	15LB200PS	230Vac-24Vdc 200W power supply waterproof plastic box IP55 LB-200/PS Length (mm): 310 Width (mm): 70 High (mm): 80 Voltage In (Vac): 230 Voltage Out (Vdc): 24 Power (W): 200 Room Temperature (°C): -20~+55 Ingress Protection: IP55	1	98,97 €
		CE  		

Catalogue **SMART LIGHTING**
Line **Casambi Lighting control**
FAMILY **Casambi Dimmer 230V**
Subfamily **Casambi Dimmer 230V**

Download CASAMBI Bluetooth catalogue [here](#).
Watch CASAMBI video tutorials on [our YouTube channel](#).

Picture	Article	Description	Lot	Price/Unit
	G50541253		1	122,16 €
	Smart Lampholder CASAMBI A800 NIP 230V 25W		5	111,06 €
	Black		10	100,92 €
			20	96,14 €
	M10x1. Use with cable section H03VVH2-F 2x1mm / H03VV-F 2x0.75mm .. With Casambi BLE 4.0 regulation integrated by intelligent device. Type of load: Incandescent / Halogen / LED Retrofit High (mm): 98,2 Diameter (mm): 33,6 Colour: Black Voltage In (Vac): 220~240 Frecuency (Hz): 50~60 Power (W): 4~25 Room Temperature (°C): +35 Reference: 039162			



SMART LIGHTING > Casambi Lighting control > Casambi Dimmer 230V

Subfamily **Casambi Dimmer 230V**

Picture	Article	Description	Lot	Price/Unit
	G50541254		1	122,16 €
	Smart Lampholder CASAMBI A801 NIP 230V 25W		5	111,06 €
	Black		10	100,92 €
			20	96,14 €
	M10x1. Use with cable section H03VVH2-F 2x1mm / H03VV-F 2x0.75mm .. With Casambi BLE 4.0 regulation integrated by intelligent device. Type of load: Incandescent / Halogen / LED Retrofit 			
	High (mm): 98,2 Diameter (mm): 33,6 Colour: Black Voltage In (Vac): 220~240 Frecuency (Hz): 50~60 Power (W): 4~25 Room Temperature (°C): +35 Reference: 040047			



	G50541255		1	122,40 €
	Smart Lampholder CASAMBI A802 NIP 230V 25W		5	111,27 €
	Black		10	101,11 €
			20	96,33 €
	M10x1. Use with cable section H03VVH2-F 2x1mm / H03VV-F 2x0.75mm .. With Casambi BLE 4.0 regulation integrated by intelligent device. Type of load: Incandescent / Halogen / LED Retrofit 			
	High (mm): 98,2 Diameter (mm): 33,6 Colour: Black Voltage In (Vac): 220~240 Frecuency (Hz): 50~60 Power (W): 4~25 Room Temperature (°C): +35 Reference: 040048			



SMART LIGHTING > Casambi Lighting control > Casambi Dimmer 230V

Subfamily **Casambi Dimmer 230V**

Picture	Article	Description	Lot	Price/Unit
	G5031180		1	125,96 €
	Dimable CC-CV plug-in LED power supply CASAMBI multi-pin 18W black		5	114,50 €
			10	104,10 €
	Dimmable with CASAMBI App and Push. Output 12 or 24Vdc or current from 200mA to 950mA in steps of 50mA programmable by Dip-Switch. Interchangeable plug EU, US, UK, CN, AU, KR and JP. Not included		50	97,31 €
	Length (mm): 122 Width (mm): 59 High (mm): 32 Colour: Black Voltage In (Vac): 100~240 Frecuency (Hz): 50~60 Power (W): 18 Room Temperature (°C): -20~+40 Critical Temperature (°C): 75 Life (Hours): 50000 Ingress Protection: IP20 Dimmable: Push Power factor: >0.95			

Reference: 040645



SMART LIGHTING > Casambi Lighting control > Casambi Dimmer 230V

Subfamily **Casambi Dimmer 230V**

Picture	Article	Description	Lot	Price/Unit
	AD800820		1	97,41 €
	Casambi Dimmer 85-240V 100W IP30 for independent use		5	88,56 €
			10	84,32 €
		<p>Dimmer to regulate light bulbs and LED modules at mains voltage and dimmable LED power supplies by end-of-phase cutting.</p> <p>Length (mm): 75 Width (mm): 38 High (mm): 22 Colour: White Voltage In (Vac): 85~240 Frecuency (Hz): 50~60 Power (W): 1~100 Room Temperature (°C): -20~+45 Critical Temperature (°C): 75 Ingress Protection: IP30</p>		



	AD800838		1	94,77 €
	Casambi Dimmer 85-240V 100W IP20 to incorporate		5	86,16 €
			10	82,06 €
		<p>Length (mm): 40,4 Width (mm): 36,3 High (mm): 14 Colour: White Voltage In (Vac): 85~240 Frecuency (Hz): 50~60 Power (W): 1~100 Room Temperature (°C): -20~+45 Critical Temperature (°C): 75 Ingress Protection: IP20</p>		



SMART LIGHTING > Casambi Lighting control > Casambi Dimmer 230V

Subfamily **Casambi Dimmer 230V**

Picture	Article	Description	Lot	Price/Unit
	AD808798		1	108,75 €
	Casambi Dimmer 85-240V 100W IP65 independent use		5	98,87 €
			10	94,15 €

Casambi dimmer to regulate mains voltage dimmable LED bulbs and modules and LED power supplies

Length (mm): 100 Width (mm): 37 High (mm): 24
 Colour: Black Voltage In (Vac): 85~240
 Frecuency (Hz): 50~60 Power (W): 1~100
 Room Temperature (°C): -20~+45
 Critical Temperature (°C): 65 Ingress Protection: IP65



	AD808945		1	224,67 €
	Casambi Dimmer 230V 300W IP20 to incorporate		5	204,24 €
			10	194,51 €

Casambi Dimmer to regulate dimmable LED bulbs and modules and dimmable LED power supplies by phase cutting.

Length (mm): 51,5 Width (mm): 47,5 High (mm): 31
 Colour: White Voltage In (Vac): 220~240
 Frecuency (Hz): 50~60 Power (W): 3~300
 Room Temperature (°C): 0~+50
 Critical Temperature (°C): 70 Ingress Protection: IP20



SMART LIGHTING > Casambi Lighting control > Casambi Dimmer 230V

Subfamily **Casambi Dimmer 230V**

Picture	Article	Description	Lot	Price/Unit
	G503913		1	78,07 €
	Dimmer Casambi D300IBC 230V 2-300W to incorporate		5	70,98 €
			10	67,60 €

Casambi dimmer to regulate light bulbs. LED modules and LED power supplies adjustable by phase cutting.

Length (mm): 45 Width (mm): 45 High (mm): 22
 Colour: White Voltage In (Vac): 220~240
 Intensidad In (A): 1.36 Frecuency (Hz): 50~60
 Power (W): 2~300 Room Temperature (°C): -20~+40
 Critical Temperature (°C): 85 Life (Hours): 50000
 Ingress Protection: IP20



	AD808946		1	253,40 €
	Casambi Dimmer 230V 380W IP20 independent use		5	230,35 €
			10	219,38 €

Casambi Dimmer to regulate dimmable LED bulbs and modules and dimmable LED power supplies by phase cutting.

Length (mm): 101,5 Width (mm): 51 High (mm): 30
 Colour: White Voltage In (Vac): 220~240
 Frecuency (Hz): 50~60 Power (W): 3~380
 Room Temperature (°C): 0~+28
 Critical Temperature (°C): 70 Ingress Protection: IP20



Catalogue **SMART LIGHTING**
Line **Casambi Lighting control**
FAMily **Dimmer Led for Casambi Interface**
Subfamily **Dimmers Led for Casambi Interface**

Watch CASAMBI video tutorials on [our YouTube channel](#).

Picture	Article	Description	Lot	Price/Unit
	AD800650		1	70,72 €
	Dimmer led CV 12-24V 4 channels DALI control		5	64,30 €
	4x60W(12V) 4x120W(24V)		10	61,24 €

Led regulator at constant voltage 12-24Vdc 4 channels controllable by DALI. 4x60W (12Vdc) 4x120W (24Vdc). Adapted for control by CASAMBI interfaces

Length (mm): 178 Width (mm): 46 High (mm): 20
Colour: White Voltage In (Vdc): 12~24
Frecuency (Hz): 50~60 Power (W): 240~480
Critical Temperature (°C): 75

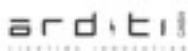

	AD800651		1	84,73 €
	Dimmer led CV 12-24V 4 channels DALI control		5	73,65 €
	4x96W(12V) 4x192W(24V)		10	70,21 €

Regulador Led constant voltage 12-24Vdc 4 channels controllable by DALI. 4x96W (12Vdc) 4x192W (24Vdc). Adapted for the control of CASAMBI interfaces

Length (mm): 170 Width (mm): 59 High (mm): 29
Colour: White Voltage In (Vdc): 12~24
Frecuency (Hz): 50~60 Power (W): 384~768
Critical Temperature (°C): 75

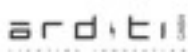

Catalogue **SMART LIGHTING**
 Line **Casambi Lighting control**
 FAmily **Casambi integrated Led Drivers and Dimmers**
 Subfamily **Casambi integrated Led Drivers**

Picture	Article	Description	Lot	Price/Unit
	AD800578		1	153,91 €
	Casambi Bluetooth DIP Switch DC / CV 25W power supply independent use		5	139,92 €
			10	133,26 €
		350mA (1,8..15W) / 500mA (2,5..22W) / 700mA (3,5..25W) / 12V (1..10W) / 24V 12V (3,1..20W) Length (mm): 149 Width (mm): 68 High (mm): 24 Colour: White Voltage In (Vac): 220~240 Frecuency (Hz): 50~60 Power (W): 1.8~2.5 Room Temperature (°C): -20~+50 Critical Temperature (°C): 75 Ingress Protection: IP20		

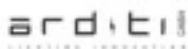

Catalogue **SMART LIGHTING**
 Line **Casambi Lighting control**
 FAmily **Casambi integrated Led Drivers and Dimmers**
 Subfamily **Casambi integrated Led Dimmers**

Picture	Article	Description	Lot	Price/Unit
	AD808948		1	225,94 €
	Dimmer Casambi 10-24V 4 channels CTT/ RGB+W		5	196,48 €
	Led Dimmer with integrated Casambi. Maximum intensity 4.4 A per channel.		10	187,10 €
		Length (mm): 56,6 Width (mm): 35,8 High (mm): 22,6 Colour: White Voltage In (Vdc): 10~24 Intensidad Out (A): 4.4 Power (W): 422 Room Temperature (°C): -20~+40 Critical Temperature (°C): 85 Ingress Protection: IP20		



Catalogue **SMART LIGHTING**
Line **Casambi Lighting control**
FAMILY **Casambi Interface 230V 0-10V**

Subfamily **Casambi Interface 230V 0-10V**

Download **CASAMBI Bluetooth catalogue** [here](#).
Watch **CASAMBI** video tutorials on [our YouTube channel](#).

Picture	Article	Description	Lot	Price/Unit
	AD800670		1	106,35 €
	Casambi Bluetooth Interface 0-10V independent use		5	96,68 €
	Casambi interface for control of feeders with 0-10V input.		10	92,08 €
		Length (mm): 75 Width (mm): 38 High (mm): 22 Colour: White Voltage In (Vac): 220~240 Voltage Out (Vdc): 0~10 Intensidad Out (A): 0.007 Frequency (Hz): 50 Room Temperature (°C): -20~+40 Critical Temperature (°C): 70		



SELV

SMART LIGHTING > Casambi Lighting control > Casambi Interface 230V 0-10V

Subfamily **Casambi Interface 230V 0-10V**

Picture	Article	Description	Lot	Price/Unit
	AD800589		1	90,79 €
	Interface Bluetooth 1-10V to control LED systems		5	82,52 €
				10

To control dimmable LED from tablet or smartphone via Bluetooth, integrated antenna 2,4-2,483GHz

Length (mm): 56,6 Width (mm): 35,8 High (mm): 22,6
 Colour: White Voltage In (Vac): 220~240
 Voltage Out (Vdc): 0~10 Intensidad Out (A): 0.007
 Frequency (Hz): 50 Room Temperature (°C): -20~+40
 Critical Temperature (°C): 70 Ingress Protection: IP20

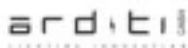

SELV

Catalogue **SMART LIGHTING**
Line **Casambi Lighting control**
FAMILY **Casambi Dimmer 230V DALI**

Subfamily **Casambi Interface DALI monocolor 1 to 4 channels**

Download **CASAMBI Bluetooth catalogue** [here](#).
Watch **CASAMBI video tutorials** on [our YouTube channel](#).

Picture	Article	Description	Lot	Price/Unit
	AD800661		1	106,15 €
		Casambi Bluetooth Interface DALI-4 channels monocolor independent use	5	96,50 €
			10	91,90 €

For the control of dimmers with DALI input and 4 mono-color output channels.

Length (mm): 75 Width (mm): 38 High (mm): 22
Colour: White Voltage In (Vac): 220~240
Intensidad Out (A): 0.007 Frecuency (Hz): 50
Room Temperature (°C): -20~+40
Critical Temperature (°C): 70

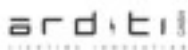

SMART LIGHTING > Casambi Lighting control > Casambi Dimmer 230V DALI

Subfamily **Casambi Interface DALI monocolor 1 to 4 channels**

Picture	Article	Description	Lot	Price/Unit
	AD800662		1	101,32 €
	Casambi Bluetooth Interface DALI-2 channels		5	92,09 €
	monocolor independent use		10	87,70 €

For the control of dimmers with DALI input and 2 output channels

Length (mm): 75 Width (mm): 38 High (mm): 22
 Colour: White Voltage In (Vac): 220~240
 Intensidad Out (A): 0.007 Frecuency (Hz): 50
 Room Temperature (°C): -20~+40
 Critical Temperature (°C): 70

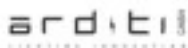

	AD800663		1	106,35 €
	Casambi Bluetooth Interface DALI-3 channels		5	96,68 €
	monocolor independent use		10	92,08 €

For the control of dimmers with DALI input and 3 mono-color output channels.

Length (mm): 75 Width (mm): 38 High (mm): 22
 Colour: White Voltage In (Vac): 220~240
 Intensidad Out (A): 0.007 Frecuency (Hz): 50
 Room Temperature (°C): -20~+40
 Critical Temperature (°C): 70

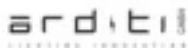

SMART LIGHTING > Casambi Lighting control > Casambi Dimmer 230V DALI

Subfamily **Casambi Interface DALI monocolor 1 to 4 channels**

Picture	Article	Description	Lot	Price/Unit
	AD800667		1	106,35 €
	Casambi Bluetooth Interface DALI-1 channel independent use		5	96,68 €
			10	92,08 €

For control of feeders with DALI input and 1 output channel.

Length (mm): 75 Width (mm): 38 High (mm): 22
 Colour: White Voltage In (Vac): 220~240
 Intensidad Out (A): 0.007 Frecuency (Hz): 50
 Room Temperature (°C): -20~+40
 Critical Temperature (°C): 70

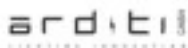

	AD800681		1	100,28 €
	Casambi Bluetooth Interface DALI-4 channels monocolor built-in housing		5	91,16 €
			10	86,84 €

For the control of dimmers with DALI input and 4 mono-color output channels.

Length (mm): 56,6 Width (mm): 35,8 High (mm): 22,6
 Colour: White Voltage In (Vac): 220~240
 Intensidad Out (A): 0.007 Frecuency (Hz): 50
 Room Temperature (°C): -20~+40
 Critical Temperature (°C): 70

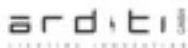

SMART LIGHTING > Casambi Lighting control > Casambi Dimmer 230V DALI

Subfamily **Casambi Interface DALI monocolor 1 to 4 channels**

Picture	Article	Description	Lot	Price/Unit
	AD800682		1	100,28 €
	Casambi Bluetooth Interface DALI-2 channels		5	91,16 €
	monocolor built-in housing		10	86,84 €

For the control of dimmers with DALI input and 2 mono-color output channels.

Length (mm): 56,6 Width (mm): 35,8 High (mm): 22,6
 Colour: White Voltage In (Vac): 220~240
 Intensidad Out (A): 0.007 Frecuency (Hz): 50
 Room Temperature (°C): -20~+40
 Critical Temperature (°C): 70



	AD800683		1	100,28 €
	Casambi Bluetooth Interface DALI-3 channels		5	91,16 €
	monocolor built-in housing		10	86,84 €

For the control of dimmers with DALI input and 4 mono-color output channels.

Length (mm): 56,6 Width (mm): 35,8 High (mm): 22,6
 Colour: White Voltage In (Vac): 220~240
 Intensidad Out (A): 0.007 Frecuency (Hz): 50
 Room Temperature (°C): -20~+40
 Critical Temperature (°C): 70

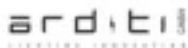

SMART LIGHTING > Casambi Lighting control > Casambi Dimmer 230V DALI

Subfamily **Casambi Interface DALI monocolor 1 to 4 channels**

Picture	Article	Description	Lot	Price/Unit
	AD800687		1	89,66 €
	Casambi Bluetooth Interface DALI-1 channel built-in housing		5	81,50 €
			10	77,64 €

For control of feeders with DALI input and 1 output channel.

Length (mm): 56,6 Width (mm): 35,8 High (mm): 22,6
 Colour: White Voltage In (Vac): 220~240
 Intensidad Out (A): 0.007 Frecuency (Hz): 50
 Room Temperature (°C): -20~+40
 Critical Temperature (°C): 70

Reference: 800687

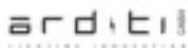

	AD801590		1	101,63 €
	Casambi DALI 0-10V interface to incorporate configurable		5	92,39 €
			10	87,98 €

Casambi interface for controlling a DALI dimmable LED power supply and a possible combination with a relay or up to two 0-10V dimmable LED power supplies

Length (mm): 76 Width (mm): 26 High (mm): 23
 Voltage In (Vac): 100~240 Voltage Out (Vdc): 0~10
 Intensidad Out (A): 0.007 Frecuency (Hz): 50~60
 Room Temperature (°C): -20~+45
 Critical Temperature (°C): 70 Ingress Protection: IP20



Catalogue **SMART LIGHTING**

Line **Casambi Lighting control**

FAMILY **Casambi Dimmer 230V DALI**

Subfamily **Casambi Interface DALI CCT, RGB, RGB+W**

Download CASAMBI Bluetooth catalogue [here.](#)

Watch CASAMBI video tutorials on [our YouTube channel.](#)

Picture	Article	Description	Lot	Price/Unit
	AD800665		1	100,98 €
	Casambi Bluetooth Interface 0-10V DALI independent use configurable		5	91,85 €
			10	87,46 €
	Configurable for 1-4 channels monocolour and CCT,RGC and RGB+W			
	Length (mm): 75 Width (mm): 38 High (mm): 22 Colour: White Voltage In (V): 220~240 Room Temperature (°C): -20~+40 Critical Temperature (°C): 70 Ingress Protection: IP30			



SMART LIGHTING > Casambi Lighting control > Casambi Dimmer 230V DALI

Subfamily Casambi Interface DALI CCT, RGB, RGB+W

Picture	Article	Description	Lot	Price/Unit
	AD800666		1	95,75 €
	Casambi Bluetooth Interface DALI-4 channels		5	87,04 €
	RGB+W independent use		10	82,89 €

For the RGB control with feeders with DALI input

Length (mm): 75 Width (mm): 38 High (mm): 22
 Colour: White Voltage In (Vac): 220~240
 Intensidad Out (A): 0.007 Frecuency (Hz): 50
 Room Temperature (°C): -20~+40
 Critical Temperature (°C): 70

Reference: 800666

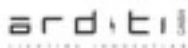

SELV

	AD800668		1	106,35 €
	Casambi Bluetooth Interface DALI-2 channels CCT		5	96,68 €
	independent use		10	92,08 €

For CCT control, warm and cold light with feeders with DALI input

Length (mm): 75 Width (mm): 38 High (mm): 22
 Colour: White Voltage In (Vac): 220~240
 Intensidad Out (A): 0.007 Frecuency (Hz): 50
 Room Temperature (°C): -20~+40
 Critical Temperature (°C): 70

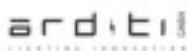

SELV

SMART LIGHTING > Casambi Lighting control > Casambi Dimmer 230V DALI

Subfamily **Casambi Interface DALI CCT, RGB, RGB+W**

Picture	Article	Description	Lot	Price/Unit
	AD800669		1	106,35 €
	Casambi Bluetooth Interface DALI-3 channels RGB independent use		5	96,68 €
			10	92,08 €

For the RGB control with feeders with DALI input

Length (mm): 75 Width (mm): 38 High (mm): 22
 Colour: White Voltage In (Vac): 220~240
 Intensidad Out (A): 0.007 Frecuency (Hz): 50
 Room Temperature (°C): -20~+40
 Critical Temperature (°C): 70

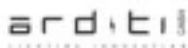

SELV

	AD800685		1	92,22 €
	Casambi 0-10V DALI interface to incorporate configurable		5	83,82 €
			10	79,83 €

Configurable for 1-4 channels monocolor and CCT,RGC and RGB+W

Length (mm): 56,6 Width (mm): 35,8 High (mm): 22,6
 Colour: White Voltage In (V): 220~240
 Room Temperature (°C): -20~+40
 Critical Temperature (°C): 70 Ingress Protection: IP20



SELV

SMART LIGHTING > Casambi Lighting control > Casambi Dimmer 230V DALI

Subfamily **Casambi Interface DALI CCT, RGB, RGB+W**

Picture	Article	Description	Lot	Price/Unit
	AD800686		1	100,28 €
	Casambi Bluetooth Interface DALI-4 channels RGB+W built-in housing		5	91,16 €
			10	86,84 €

Para el control RGB con alimentadores con entrada DALI

Length (mm): 56,6 Width (mm): 35,8 High (mm): 22,6
 Colour: White Voltage In (Vac): 220~240
 Intensidad Out (A): 0.007 Frecuency (Hz): 50
 Room Temperature (°C): -20~+40
 Critical Temperature (°C): 70

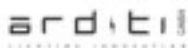

SELV

	AD800688		1	100,28 €
	Casambi Bluetooth Interface DALI-2 channels CCT built-in housing		5	91,16 €
			10	86,84 €

For CCT control, warm and cold light with feeders with DALI input

Length (mm): 56,6 Width (mm): 35,8 High (mm): 22,6
 Colour: White Voltage In (Vac): 220~240
 Intensidad Out (A): 0.007 Frecuency (Hz): 50
 Room Temperature (°C): -20~+40
 Critical Temperature (°C): 70

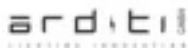

SELV

SMART LIGHTING > Casambi Lighting control > Casambi Dimmer 230V DALI

Subfamily **Casambi Interface DALI CCT, RGB, RGB+W**

Picture	Article	Description	Lot	Price/Unit
	AD800689		1	100,28 €
	Casambi Bluetooth Interface DALI-3 channels RGB built-in housing		5	91,16 €
			10	86,84 €

For the RGB control with feeders with DALI input

Length (mm): 56,6 Width (mm): 35,8 High (mm): 22,6
 Colour: White Voltage In (Vac): 220~240
 Intensidad Out (A): 0.007 Frecuency (Hz): 50
 Room Temperature (°C): -20~+40
 Critical Temperature (°C): 70

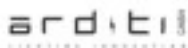

	AD808685		1	118,37 €
	Casambi Bluetooth DALI 230V IP65 interface configurable		5	107,61 €
			10	102,49 €

Casambi interface with IP65 Signal input: Bluetooth 4.0 lite. 0-10V or DALI output

Length (mm): 100 Width (mm): 37 Colour: Black
 Voltage In (Vac): 220~240 Frecuency (Hz): 50
 Room Temperature (°C): -20~+40
 Critical Temperature (°C): 70 Ingress Protection: IP65

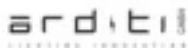

Catalogue **SMART LIGHTING**

Line **Casambi Lighting control**

FAMILY **Casambi Dimmer 12V-24V LED Strips**

Subfamily **Casambi Dimmer 12-24V monocolor led stripes 1 to 4 channels**

Download CASAMBI Bluetooth catalogue [here](#).

Watch CASAMBI video tutorials on [our YouTube channel](#).

Picture	Article	Description	Lot	Price/Unit
	AD800382		1	105,39 €
	Casambi Bluetooth Dimmer 12-24V 2 channels		5	95,81 €
	monocolor		10	91,26 €

Control of led strips and LED modules at constant voltage at 12 or 24V

Length (mm): 72,6 Width (mm): 30 High (mm): 18
 Colour: White Voltage In (Vdc): 12~24
 Power (W): 72~144
 Room Temperature (°C): -20~+45
 Critical Temperature (°C): 75





Subfamily **Casambi Dimmer 12-24V monocolor led stripes 1 to 4 channels**

Picture	Article	Description	Lot	Price/Unit
	AD800383		1	105,39 €
	Casambi Bluetooth Dimmer 12-24V 3 channels monocolor		5	95,81 €
			10	91,26 €

Control of led strips and LED modules at constant voltage at 12 or 24V

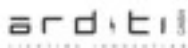
Length (mm): 72,6 Width (mm): 30 High (mm): 18
 Colour: White Voltage In (Vdc): 12~24
 Power (W): 72~144 Room Temperature (°C): -20~+45
 Critical Temperature (°C): 75



	AD800387		1	114,83 €
	Casambi Bluetooth Dimmer 12-24V 1 channel monocolor		5	104,39 €
			10	99,44 €

Control of led strips and LED modules at constant voltage at 12 or 24V

Length (mm): 72,6 Width (mm): 30 High (mm): 18
 Colour: White Voltage In (Vdc): 12~24
 Power (W): 72~144 Room Temperature (°C): -20~+45
 Critical Temperature (°C): 75

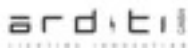

Catalogue **SMART LIGHTING**

Line **Casambi Lighting control**

FAMILY **Casambi Dimmer 12V-24V LED Strips**

Subfamily **Casambi Dimmer 12-24V CCT, RGB, RGB+W led stripes**

Download CASAMBI Bluetooth catalogue [here](#).

Watch CASAMBI video tutorials on [our YouTube channel](#).

Picture	Article	Description	Lot	Price/Unit
	AD800385		1	105,39 €
	Casambi Dimmer 12-24V 4 channels Configurable		5	95,81 €
	Control of led strips and LED modules at constant voltage at 12 or 24V		10	91,26 €
		Length (mm): 72,6 Width (mm): 30 High (mm): 18 Colour: White Voltage In (Vdc): 12~24 Power (W): 72~144 Room Temperature (°C): -20~+45 Critical Temperature (°C): 75		





Subfamily **Casambi Dimmer 12-24V CCT, RGB, RGB+W led stripes**

Picture	Article	Description	Lot	Price/Unit
	AD800386		1	105,39 €
	Casambi Bluetooth Dimmer 12-24V 4 channels RGB+W		5	95,81 €
			10	91,26 €

For the control of RGB + W LED strips and modules

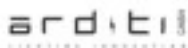
Length (mm): 72,6 Width (mm): 30 High (mm): 18
 Colour: White Voltage In (Vdc): 12~24
 Power (W): 72~144 Room Temperature (°C): -20~+45
 Critical Temperature (°C): 75



	AD800388		1	105,39 €
	Casambi Bluetooth Dimmer 12-24V 2 channels CCT		5	95,81 €
			10	91,26 €

For the control of strips and modules CCT led warm and cold light

Length (mm): 72,6 Width (mm): 30 High (mm): 18
 Colour: White Voltage In (Vdc): 12~24
 Power (W): 72~144 Room Temperature (°C): -20~+45
 Critical Temperature (°C): 75

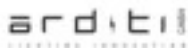

Subfamily **Casambi Dimmer 12-24V CCT, RGB, RGB+W led stripes**

Picture	Article	Description	Lot	Price/Unit
	AD800389		1	105,39 €
	Casambi Bluetooth Dimmer 12-24V 3 channels RGB		5	95,81 €
	For the control of strips and RGB led modules		10	91,26 €

Length (mm): 72,6 Width (mm): 30 High (mm): 18
 Colour: White Voltage In (Vdc): 12~24
 Power (W): 72~144 Room Temperature (°C): -20~+45
 Critical Temperature (°C): 75

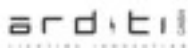

	AD808885		1	129,83 €
	Dimmer Casambi Bluetooth 12-24V 4 chanel multifuntion CCT, RGB, RGB+W		5	118,01 €
	Control of led strips and Led modules at constant voltage at 12 or 24V		10	112,41 €

Control of led strips and Led modules at constant voltage at 12 or 24V

Length (mm): 100 Width (mm): 37 Colour: Black
 Voltage In (Vdc): 12~24 Frecuency (Hz): 400
 Power (W): 72~144 Room Temperature (°C): -20~+45
 Critical Temperature (°C): 75 Ingress Protection: IP65



Catalogue **SMART LIGHTING**
Line **Furniture Lighting Control**
FAMILY **Furniture Lighting Control**
Subfamily **Led Drivers Furniture**

Picture	Article	Description	Lot	Price/Unit
	GHEACONE01		1	1,17 €
		Parallel cable 2m. Connector for furniture driver and led strip	5	0,98 €
			10	0,88 €
			100	0,83 €
		2 meter polarized cable with connector for the furniture driver and connector for 8mm solderless LED strip. Length (mm): 2000 Colour: White		

LETARON



	GHEAPLUG01		1	2,94 €
		Flat black hose connection 2m. EUR plug and figure 8 connector	5	2,44 €
			10	2,22 €
			100	2,08 €
		EUR plug and 2-pole 8-pin connector for furniture controller Length (mm): 2000 Section (mm2): 0,75 Colour: Black		

LETARON



Subfamily **Led Drivers Furniture**

Picture	Article	Description	Lot	Price/Unit
	GHED2412015		1	9,41 €
	Driver Led Furniture LSD24-12V 21.6W		5	7,84 €
	Connector for the control element and 12Vdc output with 4 connectors.		10	7,12 €
			100	6,66 €
	Length (mm): 117 Width (mm): 48 High (mm): 16,5 Colour: Black Voltage In (Vac): 220~240 Voltage Out (Vdc): 12 Intensidad Out (A): 1.8 Frecuency (Hz): 50~60 Power (W): 21.6 Room Temperature (°C): 0~+40 Critical Temperature (°C): 90 Life (Hours): 30000 Ingress Protection: IP20 Dimmable: SI			

LETARON



	GHED3612049		1	12,34 €
	Driver Led Furniture LSD36-12V 36W		5	10,28 €
	Connector for the control element and 12Vdc output with 6 connectors.		10	9,35 €
			100	8,74 €
	Length (mm): 145 Width (mm): 59 High (mm): 16,5 Colour: Black Voltage In (Vac): 220~240 Voltage Out (Vdc): 12 Intensidad Out (A): 3 Frecuency (Hz): 50~60 Power (W): 36 Room Temperature (°C): 0~+40 Critical Temperature (°C): 85 Ingress Protection: IP20 Dimmable: SI			

LETARON



SMART LIGHTING > Furniture Lighting Control > Furniture Lighting Control

Subfamily **Led Drivers Furniture**

Picture	Article	Description	Lot	Price/Unit
	GHED6012078		1	17,63 €
	Driver Led Furniture LSD60-12V 60W		5	14,69 €
	Connector for the control element and 12Vdc output with 6 connectors.		10	13,35 €
			100	12,48 €
	Length (mm): 198 Width (mm): 59 High (mm): 16,5 Colour: Black Voltage In (Vac): 220~240 Voltage Out (Vdc): 12 Intensidad Out (A): 5 Frecuency (Hz): 50~60 Power (W): 60 Temperature (°C): 85 Room Temperature (°C): 0~+40 Life (Hours): 30000 Ingress Protection: IP20 Dimmable: SI			

LETARON



Catalogue **SMART LIGHTING**
Line **Furniture Lighting Control**
FAMILY **Furniture Lighting Control**
Subfamily **Sensor Furniture**

Picture	Article	Description	Lot	Price/Unit
	GHEK0000233		1	8,81 €
	Pir Sensor Central Control PIR Switch 12Vdc		5	7,35 €
	Wired PIR sensor with 1.50m cable and 3-pin connector		10	6,68 €
			100	6,24 €
	Length (mm): 16,4 Diameter (mm): 12 Colour: Grey Voltage In (Vdc): 12 Intensidad Out (A): 0.1 Room Temperature (°C): 0~+45 Life (Hours): 30000			

LETARON



	GHEK0000286		1	9,70 €
	Switch Waving Sensor Central Control IR-MMW 12Vdc		5	8,09 €
	IR hand-pass sensor wired with 2m. cable and 3-pin connector		10	7,35 €
			100	6,86 €
	Length (mm): 47 Width (mm): 16 High (mm): 5,8 Colour: Grey Voltage In (Vdc): 12 Voltage Out (Vdc): 3.1 Intensidad Out (A): 0.01 Room Temperature (°C): 0~+45 Life (Hours): 30000			

LETARON



SMART LIGHTING > Furniture Lighting Control > Furniture Lighting Control

Subfamily **Sensor Furniture**

Picture	Article	Description	Lot	Price/Unit
	GHEK0000287		1	9,70 €
		PIR Switch Sensor Central Control PIR-MMW 12Vdc	5	8,09 €
		Wired PIR sensor with 2m cable and 3-pin connector	10	7,35 €
			100	6,86 €
		Length (mm): 47 Width (mm): 16 High (mm): 5,8 Colour: Grey Voltage Out (Vdc): 12 Room Temperature (°C): 0~+45 Life (Hours): 30000		

LETARON

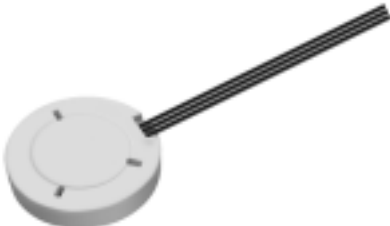

	GHEK0000299		1	4,42 €
		Switch-Dimmer Touch Sensor Central Control TS120-S 12Vdc	5	3,68 €
		touch control. Wired with 2 m cable and 3-pin connector.	10	3,34 €
			100	3,12 €
		High (mm): 4,5 Diameter (mm): 30 Colour: White Voltage Out (Vdc): 12 Room Temperature (°C): 0~+45 Life (Hours): 30000		

LETARON



SMART LIGHTING > Furniture Lighting Control > Furniture Lighting Control

Subfamily **Sensor Furniture**



Picture	Article	Description	Lot	Price/Unit
	GHEKDOOR007		1	8,22 €
	witch Door Sensor DOOR120-L 12Vdc		5	6,85 €
			10	6,23 €
	IR door sensor. wiring with connector to driver output and another connector for the led strip.		100	5,82 €
	Length (mm): 40 Width (mm): 20 High (mm): 8 Voltage In (Vdc): 12 Intensidad Out (A): 3 Room Temperature (°C): 0~+35 Critical Temperature (°C): 75 Life (Hours): 30000			

Image in another color

LETARON



	GHEKHAND019		1	8,22 €
	Switch Waving Dimmer IRD120-L 12Vdc Black		5	6,85 €
			10	6,23 €
	IR hand waving sensor. wiring with connector to driver output and another connector for the led strip.		100	5,82 €
	Length (mm): 40 Width (mm): 20 High (mm): 8 Voltage In (Vdc): 12 Intensidad Out (A): 3 Room Temperature (°C): 0~+35 Critical Temperature (°C): 75 Life (Hours): 30000			

LETARON



SMART LIGHTING > Furniture Lighting Control > Furniture Lighting Control

Subfamily **Sensor Furniture**

Picture	Article	Description	Lot	Price/Unit
	GHEKPIR0023		1	9,22 €
	PIR Sensor Switch PIR120-L 12Vdc		5	7,68 €
	PIR sensor. wiring with connector to driver output and another connector for the led strip.		10	6,98 €
	PIR sensor. wiring with connector to driver output and another connector for the led strip.		100	6,53 €
	Length (mm): 40 Width (mm): 20 High (mm): 8 Voltage In (Vdc): 12 Intensidad Out (A): 3 Room Temperature (°C): 0~+35 Critical Temperature (°C): 75			

LETARON



Catalogue **SMART LIGHTING**
Line **Furniture Lighting Control**
FAMILY **Furniture Lighting Control**
Subfamily **Wireless Furniture**

Picture	Article	Description	Lot	Price/Unit
	GHEKIR00027		1	8,81 €
	Waving-Door Sensor Sub-controller IR120-S 12Vdc		5	7,35 €
	Black		10	6,68 €
	Wired subcontroller with 5 output channels. handrail and door		100	6,24 €
	Length (mm): 63 Width (mm): 50 High (mm): 14 Colour: Black Voltage In (Vdc): 12 Intensidad Out (A): 5 Room Temperature (°C): 0~+85 Life (Hours): 30000			

LETARON



	GHEKPIR0016		1	10,28 €
	PIR Sensor Sub-controller PIR120-S 12Vdc Black		5	8,57 €
	Wired subcontroller with 5 output channels. PIR		10	7,79 €
			100	7,28 €
	Length (mm): 63 Width (mm): 50 High (mm): 14 Colour: Black Voltage In (Vdc): 12 Intensidad Out (A): 5 Room Temperature (°C): 0~+85 Life (Hours): 30000			

LETARON



Catalogue **SMART LIGHTING**
Line **Furniture Lighting Control**
FAMILY **Furniture Lighting Control**
Subfamily **Sub-control Furniture**

Picture	Article	Description	Lot	Price/Unit
	GHEK0000239		1	22,02 €
	Five Channel Dimmer Control Receiver LSK120-5		5	18,36 €
	12Vdc 5A		10	16,69 €
	Bluetooth receiver to control up to 5 monocolour channels		100	15,60 €
	Length (mm): 63 Width (mm): 50 High (mm): 14 Colour: Black Voltage In (Vdc): 12 Voltage Out (Vdc): 12 Intensidad Out (A): 6 Power (W): 72~144 Room Temperature (°C): 0~+45 Critical Temperature (°C): 75 Life (Hours): 30000			

LETARON



	GHEK0000246		1	17,33 €
	Wireless Kinetic Switch Single Key. White		5	14,44 €
	Simple kinetic switch. Autonomous operation. No cable or battery. Transforms the pulsations into energy for the signal on, off and dimmer.		10	13,13 €
			100	12,27 €
	Length (mm): 86 Width (mm): 86 High (mm): 15 Colour: White Room Temperature (°C): 0~+45 Ingress Protection: IP20			

LETARON



SMART LIGHTING > Furniture Lighting Control > Furniture Lighting Control

Subfamily **Sub-control Furniture**

Picture	Article	Description	Lot	Price/Unit
	GHEK0000247		1	19,97 €
	Wireless Kinetic Switch Two Key. White		5	16,64 €
			10	15,13 €
	Double kinetic switch. Autonomous operation. No cable or battery. Transforms the pulsations into energy for the signal on, off and dimmer.		100	14,14 €
	Length (mm): 86 Width (mm): 86 High (mm): 15 Colour: White Room Temperature (°C): 0~+45 Ingress Protection: IP20			

LETARON



	GHEK0000248		1	22,62 €
	Wireless Kinetic Switch Three Key. White		5	18,85 €
			10	17,13 €
	Triple kinetic switch. Autonomous operation. No cable or battery. Transforms the pulsations into energy for the signal on, off and dimmer.		100	16,02 €
	Length (mm): 86 Width (mm): 86 High (mm): 15 Colour: White Room Temperature (°C): 0~+45 Ingress Protection: IP20			

LETARON



SMART LIGHTING > Furniture Lighting Control > Furniture Lighting Control

Subfamily **Sub-control Furniture**

Picture	Article	Description	Lot	Price/Unit
	GHEK0000277		1	12,34 €
	Wireless Remote 433Mhz 3V Button Battery		5	10,28 €
	With CR2032 3Vdc button battery		10	9,35 €
			100	8,74 €
	High (mm): 8,8 Diameter (mm): 36,5 Colour: Black Voltage In (Vdc): 3 Room Temperature (°C): 0~+45			

LETARON



	GHEK0000304		1	13,82 €
	Wireless PIR Sensor LSK-PIR 433MHz 3V Button Battery		5	11,52 €
	PIR wireless sensor. With CR2450 3Vdc battery.		10	10,47 €
			100	9,78 €
	Length (mm): 50 Width (mm): 45 High (mm): 11 Voltage In (Vdc): 3 Room Temperature (°C): 0~+45			

LETARON



SMART LIGHTING > Furniture Lighting Control > Furniture Lighting Control

Subfamily **Sub-control Furniture**

Picture	Article	Description	Lot	Price/Unit
	GHEK0000305		1	12,34 €
	Wireless Door Sensor LSK-DOOR 433MHz 3V Button Battery		5	10,28 €
			10	9,35 €
	Wireless On/Off switch for doors. With CR2450 3Vdc battery.		100	8,74 €
	Length (mm): 50 Width (mm): 45 High (mm): 11 Voltage In (Vdc): 3 Room Temperature (°C): 0~+45			

LETARON



	GHEK0000306		1	12,34 €
	Wireless Waving Sensor LSK-HAND 433MHz 3V Button Battery		5	10,28 €
			10	9,35 €
	Hand waving wireless On/Off switch. With CR2450 3Vdc battery.		100	8,74 €
	Length (mm): 50 Width (mm): 45 High (mm): 11 Voltage In (Vdc): 3 Room Temperature (°C): 0~+45			

LETARON

