



Catalogue **LED TECHNOLOGY**
 Line **Electronic Led Power Supplies**
 Family **LED Power Supplies Constant Current**
 Subfamily **Electronic Led Power Supplies 350mA**

Picture	Article	Description	Lot	Price/Unit
	G503503		1	7,40 €
	LED Power Supply CC SLT3-350IS-1 350mA 3W		5	6,18 €
			20	5,60 €
	ECO Design ERP Compliant. Constant voltage. Class II 20cm cable in primary and secondary IP20		200	5,24 €
	Length (mm): 50 Width (mm): 30 High (mm): 20 Colour: White Voltage In (Vac): 220~240 Voltage Out (Vdc): 3~9 Intensidad Out (A): 0.35 Frecuency (Hz): 50~60 Power (W): 1~3.2 Room Temperature (°C): -20~+50 Critical Temperature (°C): 80 Ingress Protection: IP20 Dimmable: NO Power factor: 0.5			









	G503503E		1	6,10 €
	Led Power Supply CC Mini-3.6-350 350mA 3.6W IP20		5	5,54 €
			10	5,03 €
	ECO ERP Design. IP20. Constant current output 350mA.		50	4,71 €
	Length (mm): 53 Width (mm): 27 High (mm): 21 Colour: White Voltage In (Vac): 100~240 Voltage Out (V): 2.5~10 Intensidad Out (A): 0.35 Frecuency (Hz): 50~60 Power (W): 0.87~3.5 Room Temperature (°C): -20~+50 Critical Temperature (°C): 80 Life (Hours): 50000 Ingress Protection: IP20 Dimmable: NO Power factor: 0.40			



LED TECHNOLOGY > Electronic Led Power Supplies > LED Power Supplies Constant Current

Subfamily **Electronic Led Power Supplies 350mA**

Picture	Article	Description	Lot	Price/Unit
	G503503D		1	9,61 €
	LED Power Supply IP66 CC SLT3-350ISC		5	8,01 €
	350mA-4,2W		20	7,28 €
	ECO Design ERP Compliant. IP66.Constant current 350mA. Output voltage range 3-12Vdc. Class II Wiring with 15cm of cable in primary and secondary		200	6,80 €
	Length (mm): 52 Width (mm): 30 High (mm): 23 Colour: White Voltage In (Vac): 100~240 Voltage Out (Vdc): 2~9 Intensidad Out (A): 0.35 Frecuency (Hz): 50~60 Power (W): 0.7~3.15 Room Temperature (°C): -20~+50 Critical Temperature (°C): 85 Ingress Protection: IP66 Dimmable: NO Power factor: 0.5			
				
				

	G503504A		1	6,29 €
	Led Power Supply CV CC AED04-350ILS 12Vdc		10	5,24 €
	350mA 4W		50	4,76 €
	ECO Design ERP Compliant. 12Vdc constant voltage LED power supply or 350mA constant current depending on load		200	4,45 €
	Length (mm): 51,5 Width (mm): 33 High (mm): 17 Colour: White Voltage In (Vac): 100~240 Voltage Out (Vdc): 3~12 Intensidad Out (A): 0.3 Frecuency (Hz): 50~60 Power (W): 1.05~4.2 Room Temperature (°C): -10~+45 Critical Temperature (°C): 80 Life (Hours): 30000 Ingress Protection: IP20 Dimmable: NO Power factor: 0.5			
				
				

Subfamily **Electronic Led Power Supplies 350mA**

Picture	Article	Description	Lot	Price/Unit
	G503504A2		1	6,37 €
	Led Power Supply CC Mini 350mA 4W		5	5,27 €
	ECO Design ERP. IP20. 350mA constant current output		10	4,78 €
			50	4,54 €
	Length (mm): 53 Width (mm): 27 High (mm): 21 Colour: White Voltage In (Vac): 220~240 Voltage Out (Vdc): 6~12 Intensidad In (A): 0.05 Intensidad Out (A): 0.35 Frecuency (Hz): 50~60 Power (W): 2.1~4.2 Room Temperature (°C): -20~+60 Critical Temperature (°C): 85 Life (Hours): 50000 Ingress Protection: IP65 Dimmable: NO Power factor: 0.60			



	G503506C1		1	6,47 €
	Led Power Supply CC Mini IP65 350mA 6W		5	5,54 €
	ECO ERP Design. IP65. Constant current output 350mA		10	5,03 €
			50	4,71 €
	Length (mm): 53 Width (mm): 27 High (mm): 21 Colour: White Voltage In (Vac): 220~240 Voltage Out (Vdc): 9~18 Intensidad Out (A): 0.35 Frecuency (Hz): 50~60 Power (W): 0~6 Room Temperature (°C): -20~+60 Critical Temperature (°C): 85 Ingress Protection: IP65 Dimmable: NO Power factor: 0.6			



Subfamily **Electronic Led Power Supplies 350mA**

Picture	Article	Description	Lot	Price/Unit
	G503506J		1	11,10 €
	Led power supply CV CC SLT6-350IL-4 350mA (24Vdc) 6W		5	9,26 €
			10	8,41 €
			50	7,80 €
	Constant voltage 24VDC and constant current 350mA as identified by the load. Voltage range 100-240/24VDC. Class II. Length (mm): 68 Width (mm): 35 High (mm): 20 Colour: White Voltage In (Vac): 100~240 Voltage Out (Vdc): 3~22 Intensidad Out (A): 0~0.35 Frecuency (Hz): 50~60 Power (W): 0~6 Room Temperature (°C): -20~+50 Critical Temperature (°C): 75 Life (Hours): 50000 Ingress Protection: IP20 Dimmable: NO Power factor: 0.40			



	G503506L		1	6,47 €
	DC Led Power Supply MINI-6-250mA 6W		5	5,54 €
			10	5,03 €
			50	4,71 €
	ECO ERP Design. Constant current output 250mA Length (mm): 53 Width (mm): 27 High (mm): 21 Colour: White Voltage In (Vac): 220~240 Voltage Out (Vdc): 12~24 Intensidad Out (A): 0.25 Frecuency (Hz): 50~60 Power (W): 6 Room Temperature (°C): -20~+60 Critical Temperature (°C): 85 Ingress Protection: IP65 Dimmable: NO Power factor: 0.6			



LED TECHNOLOGY > Electronic Led Power Supplies > LED Power Supplies Constant Current

Subfamily **Electronic Led Power Supplies 350mA**

Picture	Article	Description	Lot	Price/Unit
	G5035081	Led Power Supply CV CC 350mA (24VDC) 8 W	1	12,81 €
			5	10,67 €
		Power supply 24VDC or constant current 350mA depending on load	10	9,71 €
			50	9,06 €
		Length (mm): 58 Width (mm): 35 High (mm): 21 Colour: White Voltage In (Vac): 110~240 Voltage Out (Vdc): 3~24 Intensidad Out (A): 0.35 Frecuency (Hz): 50~60 Power (W): 1.1~8.4 Room Temperature (°C): -25~+50 Critical Temperature (°C): 75 Ingress Protection: IP20 Dimmable: NO Power factor: 0.6 Reference: 039121		



	G5035081A	Led Power Supply CV CC AED08-350ILS 24Vdc 350mA 8 W	1	8,45 €
			10	7,05 €
		ECO Design ERP Compliant. 24Vdc constant voltage LED power supply or 350mA constant current depending on load	50	6,40 €
			200	5,98 €
		Length (mm): 79,5 Width (mm): 39 High (mm): 19 Colour: White Voltage In (Vac): 100~240 Voltage Out (Vdc): 9~22 Intensidad Out (A): 0.35 Frecuency (Hz): 50~60 Power (W): 3~7.7 Room Temperature (°C): -20~+45 Critical Temperature (°C): 80 Ingress Protection: IP20 Dimmable: NO Power factor: 0.5		



Subfamily **Electronic Led Power Supplies 350mA**

Picture	Article	Description	Lot	Price/Unit
	G503510B1		1	7,76 €
	Led Power Suply CC Mini IP65 350mA 10W		5	7,06 €
	ECO Design ERP. IP65. Constant current output 350mA 		10	6,42 €
			50	6,01 €
	Length (mm): 58 Width (mm): 36 High (mm): 20 Colour: White Voltage In (Vac): 220~240 Voltage Out (Vdc): 15~29 Intensidad Out (A): 0.35 Frecuency (Hz): 50~60 Power (W): 0~10 Room Temperature (°C): -20~+60 Critical Temperature (°C): 85 Ingress Protection: IP65 Dimmable: NO Power factor: 0.9			



	G503512B		1	8,27 €
	Led Power Supply CC Mini IP65 350mA F 12W		5	7,51 €
	ECO ERP Design. IP65. Constant current output 350mA		10	6,83 €
			50	6,38 €
	Length (mm): 50 Width (mm): 48 High (mm): 24 Colour: White Voltage In (Vac): 220~240 Voltage Out (Vdc): 17~34 Intensidad Out (A): 0.35 Frecuency (Hz): 50~60 Power (W): 0~12 Room Temperature (°C): -20~+50 Critical Temperature (°C): 80 Ingress Protection: IP65 Dimmable: NO Power factor: 0.90			



LED TECHNOLOGY > Electronic Led Power Supplies > LED Power Supplies Constant Current

Subfamily **Electronic Led Power Supplies 350mA**

Picture	Article	Description	Lot	Price/Unit
	G503515H		1	7,84 €
	Led Power Supply CC V9 350mA 15W		5	6,53 €
	ECO Design ERP Compliant. 350mA constant current output		10	5,94 €
			50	5,55 €
	Length (mm): 100 Width (mm): 38,4 High (mm): 20 Colour: White Voltage In (Vac): 220~240 Voltage Out (Vdc): 30~42 Intensidad In (A): 0.11 Intensidad Out (A): 0.35 Frecuency (Hz): 50~60 Power (W): 15 Room Temperature (°C): -20~+50 Critical Temperature (°C): 80 Life (Hours): 50000 Ingress Protection: IP20 Dimmable: NO Power factor: 0.90			



	G503515J		1	9,70 €
	DC Led Power Supply MINI-15-350mA 15W		5	8,81 €
	ECO ERP Design. Constant current output 350mA		10	8,01 €
			50	7,49 €
	Length (mm): 65 Width (mm): 43 High (mm): 24 Colour: White Voltage In (Vac): 220~240 Voltage Out (Vdc): 14~42 Intensidad In (A): 0.35 Frecuency (Hz): 50~60 Power (W): 15 Room Temperature (°C): -20~+60 Critical Temperature (°C): 85 Life (Hours): 50000 Ingress Protection: IP20 Dimmable: NO Power factor: 0.9			



Subfamily **Electronic Led Power Supplies 350mA**

Picture	Article	Description	Lot	Price/Unit
	G5035018		1	15,41 €
	Led feeder MW CC LPHC-18-350mA		10	12,86 €

Designed to work with LEDs directly, but not with Led Strips. IP67 plastic case

Length (mm): 140 Width (mm): 30 High (mm): 22
Colour: White Voltage In (Vac): 220~240
Voltage Out (Vdc): 6~48 Frecuency (Hz): 47~63
Power (W): 16.8 Dimmable: NO



	G503511A		1	18,30 €
	Led driver CC SLT20-350IF-2s 350mA 20W		5	15,25 €
	ECO design ERP. Extra-flat.Constant current 350mA.		10	13,86 €
	Voltage range 220-240Vac/6-56Vdc. Class II		50	12,86 €

Length (mm): 121 Width (mm): 45 High (mm): 16
Colour: White Voltage In (Vac): 220~240
Voltage Out (Vdc): 6~56 Intensidad Out (A): 0.35
Frecuency (Hz): 50~60 Power (W): 2.1~19.6
Room Temperature (°C): -20~+45
Critical Temperature (°C): 90 Life (Hours): 30000
Ingress Protection: IP20 Dimmable: NO
Power factor: 0.85



SELV



LED TECHNOLOGY > Electronic Led Power Supplies > LED Power Supplies Constant Current

Subfamily **Electronic Led Power Supplies 350mA**

Picture	Article	Description	Lot	Price/Unit
	G503525A		1	9,96 €
	Led Power Supply CC V8 350mA 25W		5	8,29 €
	ECO Design ERP Compliant. 350mA constant current output		10	7,53 €
			50	7,05 €
	Length (mm): 127 Width (mm): 43 High (mm): 28 Colour: White Voltage In (Vac): 220~240 Voltage Out (Vdc): 36~71 Intensidad In (A): 0.15 Intensidad Out (A): 0.35 Frecuency (Hz): 50~60 Power (W): 12.6~25 Room Temperature (°C): -20~+50 Critical Temperature (°C): 80 Life (Hours): 30000 Ingress Protection: IP20 Dimmable: NO Power factor: 0.95			



Catalogue **LED TECHNOLOGY**
 Line **Electronic Led Power Supplies**
 FAmily **LED Power Supplies Constant Current**
 Subfamily **Led Power Supplies 500mA-600mA**

Picture	Article	Description	Lot	Price/Unit
	G503603A		1	6,10 €
	Led Power Supply CC Miniu-3.6-500 500mA 3.6W		5	5,54 €
	IP20		10	5,03 €
	ECO ERP Design. IP20. Constant current output 500mA.		50	4,71 €
	Length (mm): 53 Width (mm): 27 High (mm): 21 Colour: White Voltage In (Vac): 100~240 Voltage Out (Vdc): 2.5~7 Intensidad Out (A): 0.5 Frecuency (Hz): 50~60 Power (W): 1.25~3.5 Room Temperature (°C): -20~+50 Critical Temperature (°C): 80 Life (Hours): 50000 Ingress Protection: IP20 Dimmable: NO Power factor: 0.50			



	G503504B		1	6,29 €
	Led Power Supply CC AED04-500ILS 500mA 4W		5	5,24 €
	ECO Design ERP Compliant. Constant current 500mA		10	4,76 €
			50	4,45 €
	Length (mm): 51,5 Width (mm): 32,8 High (mm): 17 Colour: White Voltage In (Vac): 100~240 Voltage Out (Vdc): 3~10.5 Intensidad Out (A): 0.5 Frecuency (Hz): 50~60 Power (W): 1.5~5.2 Room Temperature (°C): +45 Critical Temperature (°C): 80 Ingress Protection: IP20 Dimmable: NO Power factor: 0.5			



Subfamily **Led Power Supplies 500mA-600mA**

Picture	Article	Description	Lot	Price/Unit
	G503504B3		1	6,37 €
		DC Led Power Supply MINI-4-500mA 4W IP65	5	5,27 €
			10	4,78 €
		ECO ERP Design. IP65. Constant current output 500mA	50	4,54 €
		Length (mm): 48 Width (mm): 27 High (mm): 21 Colour: White Voltage In (Vac): 220~240 Voltage Out (Vdc): 4~8 Intensidad Out (A): 0.5 Frecuency (Hz): 50~60 Power (W): 2.1~4.2 Room Temperature (°C): -20~+60 Critical Temperature (°C): 85 Ingress Protection: IP65 Dimmable: NO Power factor: 0.60		



	G503606B		1	11,10 €
		Led Power Supply CC SLT6-500IL-4 500mA 6W	5	9,26 €
			10	8,41 €
		ECO design according ERP directives. Constant current 500mA. Output voltage range 3-12dc. Class II.	50	7,80 €
		Length (mm): 68 Width (mm): 35 High (mm): 20 Colour: White Voltage In (Vac): 100~240 Voltage Out (Vdc): 3~12 Intensidad Out (A): 0~0.5 Frecuency (Hz): 50~60 Power (W): 1.5~6 Room Temperature (°C): -20~+50 Critical Temperature (°C): 75 Life (Hours): 50000 Ingress Protection: IP20 Dimmable: NO Power factor: 0.40		



Subfamily **Led Power Supplies 500mA-600mA**

Picture	Article	Description	Lot	Price/Unit
	GTC21500		1	6,90 €
	Led Driver CC ECO 21-500 500mA 21W		5	6,28 €
	ECO ERP Directives. 500mA constant current power supply.		10	5,71 €
			50	5,28 €
	Length (mm): 115 Width (mm): 45 High (mm): 29 Voltage In (Vac): 220~240 Voltage Out (Vdc): 32~42 Intensidad Out (A): 0.5 Frecuency (Hz): 50~60 Power (W): 16~21 Room Temperature (°C): 0~+50 Critical Temperature (°C): 75 Ingress Protection: IP20 Dimmable: NO Power factor: 0.9 Reference: 122291			



Catalogue **LED TECHNOLOGY**
 Line **Electronic Led Power Supplies**
 Family **LED Power Supplies Constant Current**
 Subfamily **Electronic Led Power Supplies 700mA-3000mA**

Picture	Article	Description	Lot	Price/Unit
	G503703D		1	6,10 €
	Led Power Supply CC Mini-3.6-700 700mA 3.6W IP20		5	5,54 €
	ECO ERP Design. IP20. Constant current output 700mA.		10	5,03 €
			50	4,71 €
	Length (mm): 53 Width (mm): 27 High (mm): 21 Colour: White Voltage In (Vac): 100~240 Voltage Out (Vdc): 2.5~5 Intensidad Out (A): 0.7 Frecuency (Hz): 50~60 Power (W): 1.75~3.5 Room Temperature (°C): -20~+50 Critical Temperature (°C): 80 Life (Hours): 50000 Ingress Protection: IP20 Dimmable: NO Power factor: 0.50			



	G503703		1	7,93 €
	LED Power Supply LED SLT3-700IS-1 700mA 1-3W		5	6,60 €
	ECO Design ERP Compliant. Constant current. Class II, 20cm cable in primary and secondary, IP20		20	6,01 €
			200	5,60 €
	Length (mm): 50 Width (mm): 30 High (mm): 20 Colour: White Voltage In (Vac): 220~240 Voltage Out (Vdc): 2~4.2 Intensidad Out (A): 0.7 Frecuency (Hz): 50~60 Power (W): 1.4~2.9 Room Temperature (°C): -20~+45 Critical Temperature (°C): 85 Ingress Protection: IP20 Dimmable: NO Power factor: 0.5			



Subfamily **Electronic Led Power Supplies 700mA-3000mA**

Picture	Article	Description	Lot	Price/Unit
	G503504C		1	6,29 €
	Led Power Supply CV CC AED04-700ILS 5Vdc		10	5,24 €
	700mA 3,5W		50	4,76 €
	ECO Design ERP Compliant. LED power supply with constant voltage 5Vdc or constant current 700mA depending on load		200	4,45 €
	Length (mm): 51,5 Width (mm): 32,8 High (mm): 17 Colour: White Voltage In (Vac): 100~240 Voltage Out (Vdc): 3~5 Intensidad Out (A): 0.7 Frecuency (Hz): 50~60 Power (W): 2~3.5 Room Temperature (°C): +45 Critical Temperature (°C): 80 Ingress Protection: IP20 Dimmable: NO Power factor: 0.5			



	G503504C2		1	6,37 €
	DC Led Power Supply MINI-4-700mA 4W IP65		5	5,27 €
	ECO ERP Design. IP65. Constant current output 700mA		10	4,78 €
			50	4,54 €
	Length (mm): 48 Width (mm): 27 High (mm): 21 Colour: White Voltage In (Vac): 220~240 Voltage Out (Vdc): 2.5~6 Intensidad Out (A): 0.7 Frecuency (Hz): 50~60 Power (W): 2.1~4.2 Room Temperature (°C): -20~+60 Critical Temperature (°C): 85 Ingress Protection: IP65 Dimmable: NO Power factor: 0.60			



LED TECHNOLOGY > Electronic Led Power Supplies > LED Power Supplies Constant Current

Subfamily **Electronic Led Power Supplies 700mA-3000mA**

Picture	Article	Description	Lot	Price/Unit
	G503706C	Led Power Supply CV CC 700mA (12Vdc) 6W	1	17,00 €
			5	14,16 €
		Power supply in voltage 12VDC and constant current 700mA according to identified load	10	12,88 €
			50	12,04 €
		Length (mm): 42,5 Width (mm): 41 High (mm): 21 Colour: White Voltage In (Vac): 220~240 Voltage Out (Vdc): 12 Intensidad Out (A): 0.7 Frecuency (Hz): 50~60 Power (W): 0~6 Room Temperature (°C): -20~+50 Critical Temperature (°C): 85 Ingress Protection: IP20 Dimmable: NO Power factor: 0.6 Reference: 401244		

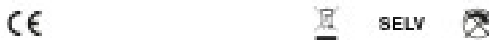

	G503706J	LED power supply CV CC SLT6-700IL-4 700mA (12Vdc) 6W	1	11,10 €
			5	9,26 €
		ECO design according to ERP directives. Led Power supply voltage 12VDC or constant current 700mA depending on load	10	8,41 €
			50	7,80 €
		Length (mm): 68 Width (mm): 35 High (mm): 20 Colour: White Voltage In (Vac): 100~240 Voltage Out (Vdc): 3~8.4 Intensidad Out (A): 0~0.7 Frecuency (Hz): 50~60 Power (W): 0~6 Room Temperature (°C): -20~+40 Critical Temperature (°C): 70 Life (Hours): 50000 Ingress Protection: IP20 Dimmable: NO Power factor: 0.40		



LED TECHNOLOGY > Electronic Led Power Supplies > LED Power Supplies Constant Current

Subfamily **Electronic Led Power Supplies 700mA-3000mA**

Picture	Article	Description	Lot	Price/Unit
	G5035081B		1	8,45 €
	Led Power Supply CV CC AED08-700ILS 12Vdc		10	7,05 €
	700mA 8 W		50	6,40 €
	ECO Design ERP Compliant. 12Vdc constant voltage LED power supply or 700mA constant current depending on load.		200	5,98 €
	Length (mm): 79,5 Width (mm): 39 High (mm): 19 Colour: White Voltage In (Vac): 100~240 Voltage Out (Vdc): 6~11 Intensidad Out (A): 0.625 Frecuency (Hz): 50~60 Power (W): 4.2~7.7 Room Temperature (°C): -10~+45 Critical Temperature (°C): 80 Life (Hours): 30000 Ingress Protection: IP20 Dimmable: NO Power factor: 0.5			

LETARON



	G503717		1	22,01 €
	Led Power Supply CC 700mA 17W		5	20,01 €
	UNTIL END OF STOCK		10	18,19 €
			50	17,00 €
	Length (mm): 125 Width (mm): 38 High (mm): 22 Colour: White Voltage In (Vac): 220~240 Voltage Out (Vdc): 3~24 Intensidad Out (A): 0.7 Frecuency (Hz): 50~60 Power (W): 0~17 Room Temperature (°C): -20~+50 Critical Temperature (°C): 75 Ingress Protection: IP20 Dimmable: NO Power factor: 0.6 Reference: 401231			

arditi
LUMEN INNOVATION



Subfamily **Electronic Led Power Supplies 700mA-3000mA**

Picture	Article	Description	Lot	Price/Unit
	G503715		1	14,09 €
	Led Power Supply LED SLT20-700IFG 700mA 20W		5	11,74 €
	6-29V		10	10,67 €
	Constant current Class II. EMC EN61000-3-2 class C.		50	9,97 €
	Length (mm): 166 Width (mm): 40 High (mm): 14 Colour: White Voltage In (Vac): 220~240 Voltage Out (Vdc): 6~29 Intensidad Out (A): 0.7 Frecuency (Hz): 50~60 Power (W): 4.2~20 Room Temperature (°C): -20~+50 Critical Temperature (°C): 85 Ingress Protection: IP20 Dimmable: NO Power factor: 0.5			



	G503715A		1	17,62 €
	Led Power Supply CC SLT20-700IF-2S 700mA 20W		5	14,68 €
	ECO design according to ERP directives. Ultra flat 16mm. Constant current 700mA. Voltage range 220-240/6-29VDC. Class II. Full load efficiency >80%		10	13,34 €
			50	12,35 €
	Length (mm): 121 Width (mm): 45 High (mm): 16 Colour: White Voltage In (Vac): 220~240 Voltage Out (Vdc): 6~29 Intensidad Out (A): 0.7 Frecuency (Hz): 50~60 Power (W): 4.2~20.3 Room Temperature (°C): -20~+45 Critical Temperature (°C): 90 Life (Hours): 30000 Ingress Protection: IP20 Dimmable: NO Power factor: 0.85			



LED TECHNOLOGY > Electronic Led Power Supplies > LED Power Supplies Constant Current

Subfamily **Electronic Led Power Supplies 700mA-3000mA**

Picture	Article	Description	Lot	Price/Unit
	G503525B		1	9,22 €
	Led Power Supply CC V8 700mA 25W		5	7,67 €
	ECO Design ERP Compliant. 700mA constant current output		10	6,97 €
			50	6,51 €
	Length (mm): 127 Width (mm): 43 High (mm): 28 Colour: White Voltage In (Vac): 220~240 Voltage Out (Vdc): 18~36 Intensidad In (A): 0.15 Intensidad Out (A): 0.7 Frecuency (Hz): 50~60 Power (W): 12.6~25 Room Temperature (°C): -20~+50 Critical Temperature (°C): 80 Life (Hours): 30000 Ingress Protection: IP20 Dimmable: NO Power factor: 0.95			



	G503530C		1	9,67 €
	Led Power Supply CC V9 700mA 30W		5	8,05 €
	ECO Design ERP Compliant. 700mA constant current output		10	7,32 €
			50	6,85 €
	Length (mm): 116 Width (mm): 41 High (mm): 25 Colour: White Voltage In (Vac): 220~240 Voltage Out (Vdc): 30~42 Intensidad In (A): 0.18 Intensidad Out (A): 0.7 Frecuency (Hz): 50~60 Power (W): 21~30 Room Temperature (°C): -20~+50 Critical Temperature (°C): 80 Life (Hours): 50000 Ingress Protection: IP20 Dimmable: NO Power factor: 0.95			



Subfamily **Electronic Led Power Supplies 700mA-3000mA**

Picture	Article	Description	Lot	Price/Unit
	GTC30700		1	39,17 €
	Led CC power supply IPR2-30/700 700mA 30W		5	35,61 €
	ECO ERP design. 700mA constant current power supply.		10	32,37 €
			30	29,98 €
	Length (mm): 115 Width (mm): 53,5 High (mm): 26 Voltage In (Vac): 110~240 Voltage Out (Vdc): 5~43 Intensidad Out (A): 0.7 Frecuency (Hz): 50~60 Power (W): 3.5~30 Room Temperature (°C): -40~+60 Critical Temperature (°C): 90 Ingress Protection: IP68 Dimmable: NO Power factor: 0.97			
Reference: 152014/700				



	GTC32700		1	10,96 €
	Led Driver CC ECO 32-700-750mA 32W		5	9,97 €
	ECO ERP Directives. 700-750mA constant current power supply.		10	9,06 €
			40	8,39 €
	Length (mm): 108 Width (mm): 68 High (mm): 32 Voltage In (Vac): 220~240 Voltage Out (Vdc): 30~42 Intensidad Out (A): 0.7~0.75 Frecuency (Hz): 50~60 Power (W): 21~32 Room Temperature (°C): 0~+50 Critical Temperature (°C): 80 Ingress Protection: IP20 Dimmable: NO Power factor: 0.92			
Reference: 122293				



Catalogue **LED TECHNOLOGY**
 Line **Electronic Led Power Supplies**
 Family **LED Power Supplies Constant Current**
 Subfamily **Led Power Suplies Dip-Switch multicurrent**

Picture	Article	Description	Lot	Price/Unit
	G503610		1	8,71 €
	DC Led Power Supply MIW-10 multi-corriente up to 500mA 10W		5	7,92 €
			10	7,20 €
			50	6,73 €
	ECODesign ERP. To incorporate. Constant current output selectable from 250mA to 500mA by DIP switch.			
	Length (mm): 54 Width (mm): 40 High (mm): 24 Colour: White Voltage In (Vac): 100~277 Intensidad Out (A): 0.25~0.5 Frecuency (Hz): 50~60 Power (W): 10 Room Temperature (°C): -20~+60 Critical Temperature (°C): 90 Life (Hours): 50000 Ingress Protection: IP20 Power factor: 0.90			



Subfamily **Led Power Suplies Dip-Switch multicurrent**

Picture	Article	Description	Lot	Price/Unit
	G503715B		1	9,32 €
	DC Led Power Supply MIW-15 multi-corriente up to 700mA 15W		5	8,46 €
			10	7,70 €
			50	7,19 €
	ECODesign ERP. To incorporate. Constant current output selectable from 300mA to 700mA by DIP switch.			
	Length (mm): 54 Width (mm): 40 High (mm): 24 Colour: White Voltage In (Vac): 100~277 Intensidad In (A): 0.2 Intensidad Out (A): 0.3~0.7 Frecuency (Hz): 50~60 Power (W): 15 Room Temperature (°C): -20~+50 Critical Temperature (°C): 90 Life (Hours): 50000 Ingress Protection: IP20 Power factor: 0.90			



	GTC15360		1	18,27 €
	Led Driver CC MP 15 HPFU multi-current up to 360mA 15W		5	16,60 €
			10	15,09 €
			50	13,98 €
	ECO ERP Directives. Selectable output current from 60mA to 360mA by DIP-SWITCH.			
	Length (mm): 115 Width (mm): 34 High (mm): 19 Voltage In (Vac): 100~240 Voltage Out (Vdc): 2~41.5 Intensidad Out (A): 0.06~0.36 Frecuency (Hz): 50~60 Power (W): 0.12~15 Room Temperature (°C): -25~+45 Critical Temperature (°C): 75 Ingress Protection: IP20 Dimmable: NO Power factor: 0.8 Reference: 127710			



Subfamily **Led Power Suplies Dip-Switch multicurrent**

Picture	Article	Description	Lot	Price/Unit
	G503609		1	19,25 €
	LED Power Supply CC SLT20-500IL-UN multi output current 150-500mA		5	16,06 €
			10	14,60 €
			100	13,65 €
	ECO Design ERP Compliant. Selectable constant output current from 150mA to 500mA by DIP switch. Class II			
	Length (mm): 85,3 Width (mm): 41 High (mm): 22 Colour: White Voltage In (Vac): 110~277 Voltage Out (Vdc): 5~40 Intensidad Out (A): 0.15~0.5 Frecuency (Hz): 50~60 Power (W): 0.75~20 Room Temperature (°C): -25~+50 Critical Temperature (°C): 85 Life (Hours): 50000 Ingress Protection: IP20 Dimmable: NO Power factor: 0.70-0.90			



	G503720A		1	11,15 €
	DC Led Power Supply MIW-20 multi-corriente up to 700mA 20W		5	10,14 €
			10	9,20 €
			50	8,61 €
	ECODesign ERP. To incorporate. Constant current output selectable from 350mA to 700mA by DIP switch.			
	Length (mm): 65 Width (mm): 43 High (mm): 24 Colour: White Voltage In (Vac): 100~277 Intensidad In (A): 0.25 Intensidad Out (A): 0.35~0.7 Frecuency (Hz): 50~60 Power (W): 20 Room Temperature (°C): -20~+60 Critical Temperature (°C): 60 Life (Hours): 50000 Ingress Protection: IP20 Power factor: 0.90			



Subfamily **Led Power Suplies Dip-Switch multicurrent**



Picture	Article	Description	Lot	Price/Unit
	GTC20700		1	17,71 €
	Led Driver CV CC UNIVERSALE 20 multi-current up to 700mA 20W		5	16,11 €
			10	14,64 €
			50	13,55 €
	ECO ERP Directives. Output current selectable by DIP-SWITCH from 250mA to 700mA and at constant voltage 24Vdc			
	Length (mm): 111 Width (mm): 52 High (mm): 22 Voltage In (Vac): 220~240 Intensidad Out (A): 0.25~0.7 Frecuency (Hz): 50~60 Power (W): 1~20 Room Temperature (°C): -25~+50 Critical Temperature (°C): 80 Ingress Protection: IP20 Dimmable: NO Power factor: 0.97 Reference: 122201			





	GTC2090B		1	15,07 €
	Led Driver CC UNIVERSALE 20HC multi-current 900mA 20W		5	13,68 €
			10	12,45 €
			50	11,53 €
	ECO ERP Directives. Output current selectable by DIP-SWITCH from 350mA to 900mA and at constant voltage 24Vdc			
	Length (mm): 111 Width (mm): 52 High (mm): 22 Voltage In (Vac): 110~240 Intensidad Out (A): 0.35~0.9 Frecuency (Hz): 50~60 Power (W): 1~20 Room Temperature (°C): -25~+50 Critical Temperature (°C): 75 Ingress Protection: IP20 Dimmable: NO Power factor: 0.93 Reference: 122198			



Subfamily **Led Power Suplies Dip-Switch multicurrent**

Picture	Article	Description	Lot	Price/Unit
	A413980		1	24,62 €
	Led power supply CC Minibravo RN1398		5	18,94 €
	350-500-700mA 14-20-22W		10	18,12 €
	Output to constant current 350mA (15W) -500mA (20W) -700mA (22W) selectable with jumper.		40	17,62 €
	High (mm): 24 Diameter (mm): 72 Voltage In (Vac): 220~240 Voltage Out (Vdc): 48 Intensidad Out (A): 0.35~0.7 Frecuency (Hz): 50~60 Power (W): 14~22 Room Temperature (°C): -20~+40 Critical Temperature (°C): 80 Ingress Protection: IP20 Power factor: 0.57			
				

	GTC22500		1	11,27 €
	Led Driver CC PROFLAT 22 Multicurrent up to 500mA 22W		5	10,24 €
	ECO ERP Directives. DIP-SWITCH selectable output current from 125mA to 500mA		10	9,31 €
	Length (mm): 146 Width (mm): 43 High (mm): 22 Voltage In (Vac): 220~240 Intensidad Out (A): 0.125~0.5 Frecuency (Hz): 50~60 Power (W): 3~22 Room Temperature (°C): -25~+45 Critical Temperature (°C): 75 Ingress Protection: IP20 Dimmable: NO Power factor: 0.9		50	8,63 €
	Reference: 127570			
				

Subfamily **Led Power Suplies Dip-Switch multicurrent**

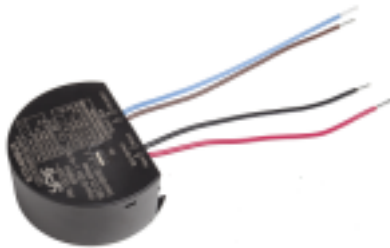
Picture	Article	Description	Lot	Price/Unit
	G503623		1	19,02 €
	Led CC power supply SLT23-600IB-UN multicurrent up to 600mA 23W		5	15,85 €
			10	14,40 €
			50	13,34 €
	ECO ERP design. To incorporate. DC output from 200 to 600mA with steps of 50mA.			
		High (mm): 27 Diameter (mm): 64 Colour: Black Voltage In (Vac): 120~240 Voltage Out (Vdc): 6~42 Frecuency (Hz): 50~60 Power (W): 4~23.4 Room Temperature (°C): -20~+60 Critical Temperature (°C): 90 Ingress Protection: IP20 Dimmable: NO Power factor: 0.7-0.95		



	G503611		1	15,83 €
	LED Power Supply CC SLT25-600IL-E multi output current 250-600mA		5	13,20 €
			10	11,99 €
			100	11,21 €
	ECO Design ERP Compliant. Selectable constant output current from 250mA to 600mA by DIP switch.			
		Length (mm): 85,3 Width (mm): 41 High (mm): 22 Colour: White Voltage In (Vac): 220~240 Voltage Out (Vdc): 27~42 Intensidad Out (A): 0.25~0.6 Frecuency (Hz): 50~60 Power (W): 6.7~25.2 Room Temperature (°C): -20~+50 Critical Temperature (°C): 90 Ingress Protection: IP20 Dimmable: NO Power factor: 0.8-0.9		

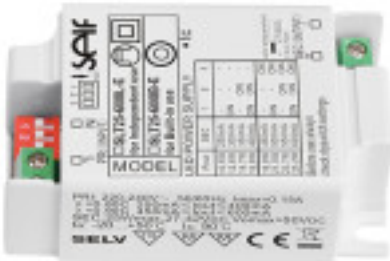

Subfamily **Led Power Suplies Dip-Switch multicurrent**

Picture	Article	Description	Lot	Price/Unit
	G503611B		1	14,39 €
	LED Power Supply CC SLT25-600IB-E multi output current 250-600mA		5	11,99 €
			10	10,91 €
			100	10,19 €
	Selectable constant output current from 250mA to 600mA per DIP switch. Model without blue caps. To incorporate			
	Length (mm): 66,7 Width (mm): 41 High (mm): 22 Colour: White Voltage In (Vac): 220~240 Voltage Out (Vdc): 27~42 Intensidad Out (A): 0.25~0.6 Frecuency (Hz): 50~60 Power (W): 6.7~25.2 Room Temperature (°C): -20~+50 Critical Temperature (°C): 90 Ingress Protection: IP20 Dimmable: NO Power factor: 0.8-0.9			



	GTC32725		1	14,61 €
	Led Driver CC PROFLAT 30 Multicurrent up to 725mA 32W		5	13,29 €
			10	12,08 €
			50	11,18 €
	ECO ERP Directives. DIP-SWITCH selectable output current from 350mA to 725mA			
	Length (mm): 146 Width (mm): 43 High (mm): 22 Voltage In (Vac): 220~240 Intensidad Out (A): 0.35~0.725 Frecuency (Hz): 50~60 Power (W): 3~32 Room Temperature (°C): -25~+45 Critical Temperature (°C): 85 Ingress Protection: IP20 Dimmable: NO Power factor: 0.95			
	Reference: 127572			



Subfamily **Led Power Suplies Dip-Switch multicurrent**

Picture	Article	Description	Lot	Price/Unit
	G503801		1	23,96 €
	LED Power Supply CC SLT35-1000IL-UN multi output current 250-1000mA		5	21,79 €
			10	19,81 €
			50	18,51 €
	ECO Design ERP Compliant. Selectable constant output current from 250mA to 1000mA by DIP switch.Class II			
	Length (mm): 135,5 Width (mm): 39 High (mm): 30 Colour: White Voltage In (Vac): 110~277 Voltage Out (Vdc): 2~50 Intensidad Out (A): 0.25~1 Frecuency (Hz): 50~60 Power (W): 0.5~35 Room Temperature (°C): -25~+50 Critical Temperature (°C): 90 Ingress Protection: IP20 Dimmable: NO Power factor: 0.75-0.9			



Subfamily **Led Power Suplies Dip-Switch multicurrent**

Picture	Article	Description	Lot	Price/Unit
	G503801B		1	22,18 €
	LED Power Supply CC SLT35-1000IB-UN multi output current 250-1000mA		5	20,16 €
			10	18,33 €
			50	17,13 €
	ECO Design ERP. Selectable constant output current from 250mA to 1000mA per DIP switch. Model without blue caps. To incorporate			
	Length (mm): 95,6 Width (mm): 39 High (mm): 30 Colour: White Voltage In (Vac): 110~277 Voltage Out (Vdc): 2~50 Intensidad Out (A): 0.25~1 Frequency (Hz): 50~60 Power (W): 0.5~35 Room Temperature (°C): -25~+50 Critical Temperature (°C): 90 Ingress Protection: IP20 Dimmable: NO Power factor: 0.75-0.9			



	GTC401050		1	17,71 €
	Led Driver CC PROFLAT 40 multi-current 1050mA 40W		5	16,11 €
			10	14,64 €
			50	13,56 €
	ECO ERP Directives. Output current selectable by DIP-SWITCH from 300mA to 1050mA			
	Length (mm): 146 Width (mm): 43 High (mm): 22 Voltage In (Vac): 220~240 Intensidad Out (A): 0.3~1.05 Frequency (Hz): 50~60 Power (W): 5~40 Room Temperature (°C): -25~+45 Critical Temperature (°C): 90 Ingress Protection: IP20 Dimmable: NO Power factor: 0.95 Reference: 127574			



Subfamily **Led Power Suplies Dip-Switch multicurrent**

Picture	Article	Description	Lot	Price/Unit
	G503805		1	17,46 €
	LED Power Supply CC SLT45-1050IL-E multi output current 700-1050mA		5	15,87 €
			10	14,44 €
			50	13,49 €
	ECO Design ERP Compliant. Selectable constant output current from 700mA to 1050mA by DIP switch.			
	Length (mm): 139 Width (mm): 42 High (mm): 29,8 Colour: White Voltage In (Vac): 220~240 Voltage Out (Vdc): 27~42 Intensidad Out (A): 0.7~1.05 Frecuency (Hz): 50~60 Power (W): 18.9~42 Room Temperature (°C): -25~+50 Critical Temperature (°C): 85 Ingress Protection: IP20 Dimmable: NO Power factor: 0.95			



	GTC421050		1	19,11 €
	Led Driver CC PROFESSIONAL 42 multi-current up to 1050mA 42W		5	17,38 €
			10	15,80 €
			40	14,63 €
	ECO ERP Directives. DIP-SWITCH selectable output current from 300mA to 1050mA			
	Length (mm): 146 Width (mm): 43 High (mm): 30 Voltage In (Vac): 220~240 Intensidad Out (A): 0.3~1.05 Frecuency (Hz): 50~60 Power (W): 1~42 Room Temperature (°C): -25~+40 Critical Temperature (°C): 80 Ingress Protection: IP20 Dimmable: NO Power factor: 0.95 Reference: 127484N			



Subfamily **Led Power Suplies Dip-Switch multicurrent**

Picture	Article	Description	Lot	Price/Unit
	G503815		1	26,27 €
	Led CC power supply SLT45-1150IB-UN multicurrent up to 1150mA 45W		5	21,89 €
			10	19,90 €
			50	18,43 €
	ECO ERP design. To incorporate. DC output from 400 to 1150mA with steps of 50mA.			
	High (mm): 30 Diameter (mm): 75,5 Colour: Black Voltage In (Vac): 120~240 Voltage Out (Vdc): 6~42 Frecuency (Hz): 50~60 Power (W): 45 Room Temperature (°C): -20~+60 Critical Temperature (°C): 90 Ingress Protection: IP20 Dimmable: NO Power factor: 0.95			



	GTC55350		1	15,18 €
	Led Driver CC MPSE 55-350 multicurrent up to 350mA 55W		5	13,79 €
			10	12,55 €
			70	11,61 €
	ECO ERP Directives. DIP-SWITCH selectable output current from 100mA to 350mA			
	Length (mm): 237 Width (mm): 30 High (mm): 21 Voltage In (Vac): 220~240 Intensidad Out (A): 0.1~0.35 Frecuency (Hz): 50~60 Power (W): 7~55 Room Temperature (°C): -25~+50 Critical Temperature (°C): 85 Ingress Protection: IP20 Dimmable: NO Power factor: 0.95			
	Reference: 127524			



Subfamily **Led Power Suplies Dip-Switch multicurrent**

Picture	Article	Description	Lot	Price/Unit
	G5035080		1	20,18 €
	Led Power Supply SLT80-350IL-EU Multi-current up to 350mA 80W		5	18,34 €
	SLR-2021 Compliant. Selectable constant current from 200mA to 350mA by DIP switch.		10	16,67 €
			50	15,60 €
		Length (mm): 280 Width (mm): 30 High (mm): 22 Colour: White Voltage In (Vac): 220~240 Voltage Out (Vdc): 110~270 Intensidad Out (A): 0.2~0.35 Frecuency (Hz): 50~60 Power (W): 23~80 Room Temperature (°C): -20~+50 Critical Temperature (°C): 85 Ingress Protection: IP20 Dimmable: NO Power factor: 0.9		
				
	G5037080		1	20,18 €
	LED Power Supply CC SLT80-700IL-EU multi-current up to 700mA 80W		5	18,34 €
	ECO Design ERP Compliant. Selectable constant output current from 325mA to 700mA by DIP switch.		10	16,67 €
			50	15,60 €
		Length (mm): 280 Width (mm): 30 High (mm): 22 Colour: White Voltage In (Vac): 220~240 Voltage Out (Vdc): 40~246 Intensidad Out (A): 0.32~0.7 Frecuency (Hz): 50~60 Power (W): 34~80 Room Temperature (°C): -25~+50 Critical Temperature (°C): 90 Ingress Protection: IP20 Dimmable: NO Power factor: 0.9		
				

Subfamily **Led Power Suplies Dip-Switch multicurrent**

Picture	Article	Description	Lot	Price/Unit
	GTC80500		1	16,30 €
	Led Driver CC MP 80-500 SLIM multi-current up to 500mA 80W		5	14,82 €
			10	13,48 €
			72	12,48 €
	ECO ERP Directives. DIP-SWITCH selectable output current from 350mA to 500mA			
	Length (mm): 280 Width (mm): 30 High (mm): 21 Voltage In (Vac): 220~240 Intensidad Out (A): 0.35~0.5 Frecuency (Hz): 50~60 Power (W): 10~80 Room Temperature (°C): -25~+50 Critical Temperature (°C): 85 Ingress Protection: IP20 Dimmable: NO Power factor: 0.95 Reference: 122214I			



	GTC80700		1	17,15 €
	Led Driver CC MP 80-700 SLIM multi-current up to 700mA 80W		5	15,59 €
			10	14,17 €
			72	13,12 €
	ECO ERP Directives. DIP-SWITCH selectable output current from 325mA to 700mA			
	Length (mm): 280 Width (mm): 30 High (mm): 21 Voltage In (Vac): 220~240 Intensidad Out (A): 0.325~0.7 Frecuency (Hz): 50~60 Power (W): 10~80 Room Temperature (°C): -25~+50 Critical Temperature (°C): 85 Ingress Protection: IP20 Dimmable: NO Power factor: 0.95 Reference: 122213			



Subfamily Led Power Suplies Dip-Switch multicurrent

Picture	Article	Description	Lot	Price/Unit
	G5037160		1	27,77 €
	Led Power Supply Multi-current LED		5	25,25 €
	SLT160-700IL-EU jusqu'à 700mA 160W		10	22,96 €
	SLR-2021 Compliant. Selectable constant output current from 350mA to 700mA by DIP switch.		50	21,45 €
	Length (mm): 280 Width (mm): 30 High (mm): 22 Colour: White Voltage In (Vac): 220~240 Voltage Out (Vdc): 120~228 Intensidad Out (A): 0.35~0.7 Frecuency (Hz): 50~60 Power (W): 42~160 Room Temperature (°C): -20~+50 Critical Temperature (°C): 90 Ingress Protection: IP20 Dimmable: NO Power factor: 0.95			



Catalogue **LED TECHNOLOGY**
 Line **Electronic Led Power Supplies**
 FAmily **LED Power Supplies Constant Current**
 Subfamily **Electronic Led power dimmable constant current**

Picture	Article	Description	Lot	Price/Unit
	G503504A3		1	12,09 €
	Dimmable Led Power Supply Mini 350mA 4W		5	10,08 €
	ECO Design ERP. IP20. 350mA constant current output. Dimmable by leading or trailing edge dimmers.		10	9,17 €
			50	8,71 €
	Length (mm): 48 Width (mm): 30 High (mm): 20 Colour: White Voltage In (Vac): 220~240 Voltage Out (Vdc): 6~12 Intensidad In (A): 0.03 Intensidad Out (A): 0.35 Frecuency (Hz): 50~60 Power (W): 2~4 Room Temperature (°C): -20~+60 Critical Temperature (°C): 85 Life (Hours): 50000 Ingress Protection: IP65 Dimmable: Corte inicio o fin de fase Power factor: 0.90			



Subfamily **Electronic Led power dimmable constant current**

Picture	Article	Description	Lot	Price/Unit
	G503504B2		1	12,09 €
	Dimmable CC Led Power Supply Mini-4-500T 500mA		5	10,08 €
	4W IP65		10	9,17 €
	ECO ERP Design. IP65. Constant current output 500mA. Adjustable cut start or end of phase		50	8,71 €
	Length (mm): 48 Width (mm): 30 High (mm): 20 Colour: White Voltage In (Vac): 220~240 Voltage Out (Vdc): 4~8 Intensidad Out (A): 0.5 Frecuency (Hz): 50~60 Power (W): 2~4 Room Temperature (°C): -20~+60 Critical Temperature (°C): 85 Life (Hours): 50000 Ingress Protection: IP65 Dimmable: Corte inicio o fin de fase Power factor: 0.90			



	G503504D		1	12,09 €
	Dimmable DC Led Power Supply MINI-4-260T 260mA		300	7,67 €
	4W IP65			
	ECO ERP Design. IP65. Constant current output 260mA. Adjustable start or end of phase cut			
	Length (mm): 48 Width (mm): 30 High (mm): 20 Colour: White Voltage In (Vac): 220~240 Voltage Out (Vdc): 8~16 Intensidad Out (A): 0.26 Frecuency (Hz): 50~60 Power (W): 4 Room Temperature (°C): -20~+60 Critical Temperature (°C): 90 Life (Hours): 50000 Ingress Protection: IP65 Dimmable: Corte inicio o fin de fase Power factor: 0.90			



LED TECHNOLOGY > Electronic Led Power Supplies > LED Power Supplies Constant Current

Subfamily **Electronic Led power dimmable constant current**

Picture	Article	Description	Lot	Price/Unit
	G503704		1	12,09 €
	Dimmable DC Mini-4-700T 700mA 4W IP65 Led Power Supply		5	10,08 €
			10	9,17 €
			50	8,71 €
	ECO ERP Design. IP65. Constant current output 700mA. Adjustable cut start or end of phase			
	Length (mm): 48 Width (mm): 30 High (mm): 20 Colour: White Voltage In (V): 220~240 Voltage Out (Vdc): 2.5~6 Intensidad Out (A): 0.7 Frecuency (Hz): 50~60 Power (W): 2~4 Room Temperature (°C): -20~+60 Critical Temperature (°C): 85 Life (Hours): 50000 Ingress Protection: IP65 Dimmable: Corte inicio o fin de fase Power factor: 0.90			



	G503506C2		1	12,65 €
	Dimmable Led Power Supply Mini 350mA 6W		5	10,54 €
			10	9,59 €
			50	8,97 €
	ECO ERP Design. IP65. Constant current output 350mA. Adjustable cut start or end of phase			
	Length (mm): 48 Width (mm): 30 High (mm): 20 Colour: White Voltage In (Vac): 220~240 Voltage Out (Vdc): 9~17 Intensidad Out (A): 0.35 Frecuency (Hz): 50~60 Power (W): 0~6 Room Temperature (°C): -20~+60 Critical Temperature (°C): 85 Ingress Protection: IP65 Dimmable: Corte inicio o fin de fase Power factor: 0.90			



Subfamily **Electronic Led power dimmable constant current**

Picture	Article	Description	Lot	Price/Unit
	G503606C		1	9,20 €
	Dimmable DC Led Power Supply Mini-6-500T 500mA		5	8,37 €
	6W IP65		10	7,61 €
	ECO ERP Design. IP65. Constant current output 500mA. Adjustable cut start or end of phase		50	7,11 €
	Length (mm): 48 Width (mm): 30 High (mm): 20 Colour: White Voltage In (Vac): 220~240 Voltage Out (Vdc): 6~12 Intensidad Out (A): 0.5 Frecuency (Hz): 50~60 Power (W): 3~6 Room Temperature (°C): -20~+60 Critical Temperature (°C): 90 Life (Hours): 50000 Ingress Protection: IP65 Dimmable: Corte inicio o fin de fase Power factor: 0.90			



	G503706K		1	9,20 €
	Dimmable DC Led Power Supply Mini-6-700T 700mA		5	8,37 €
	6W IP65		10	7,61 €
	ECO ERP Design. IP65. Constant current output 700mA. Adjustable cut start or end of phase		50	7,11 €
	Length (mm): 48 Width (mm): 30 High (mm): 20 Colour: White Voltage In (Vac): 220~240 Voltage Out (Vdc): 4~9 Intensidad Out (A): 0.7 Frecuency (Hz): 50~60 Power (W): 3~6 Room Temperature (°C): -20~+60 Critical Temperature (°C): 85 Life (Hours): 50000 Ingress Protection: IP65 Dimmable: Corte inicio o fin de fase Power factor: 0.90			



Subfamily **Electronic Led power dimmable constant current**

Picture	Article	Description	Lot	Price/Unit
	G503510B2		1	13,17 €
	Dimmable Led Power Supply Mini 350mA 10W		5	10,97 €
	ECO ERP Design. IP65. Constant current output 350mA. Adjustable cut start or end of phase		10	9,97 €
			50	9,32 €
	Length (mm): 58 Width (mm): 36 High (mm): 20 Colour: White Voltage In (Vac): 220~240 Voltage Out (Vdc): 14~29 Intensidad Out (A): 0.35 Frequency (Hz): 50~60 Power (W): 5~10 Room Temperature (°C): -20~+60 Critical Temperature (°C): 90 Ingress Protection: IP65 Dimmable: Corte inicio o fin de fase Power factor: 0.9			



	G503510F		1	9,54 €
	Dimmable DC Led Power Supply Mini-10-500T 500mA 10W IP65		5	8,67 €
	ECO ERP Design. IP65. Constant current output 500mA. Adjustable cut start or end of phase		10	7,88 €
			50	7,36 €
	Length (mm): 58 Width (mm): 36 High (mm): 20 Colour: White Voltage In (Vac): 220~240 Voltage Out (Vdc): 10~20 Intensidad Out (A): 0.5 Frequency (Hz): 50~60 Power (W): 5~10 Room Temperature (°C): -20~+60 Critical Temperature (°C): 90 Life (Hours): 50000 Ingress Protection: IP65 Dimmable: Corte inicio o fin de fase Power factor: 0.90			



Subfamily **Electronic Led power dimmable constant current**

Picture	Article	Description	Lot	Price/Unit
	G503710C		1	9,54 €
	Dimmable DC Led Power Supply Mini-10-700T		5	8,67 €
	700mA 10W IP65		10	7,88 €
	ECO ERP Design. IP65. Constant current output 700mA. Adjustable cut start or end of phase		50	7,36 €
	Length (mm): 58 Width (mm): 36 High (mm): 20 Colour: White Voltage In (Vac): 220~240 Voltage Out (Vdc): 7~15 Intensidad Out (A): 0.7 Frecuency (Hz): 50~60 Power (W): 5~10 Room Temperature (°C): -20~+60 Critical Temperature (°C): 90 Life (Hours): 50000 Ingress Protection: IP65 Dimmable: Corte inicio o fin de fase Power factor: 0.90			



	G503712B		1	21,05 €
	Power supply Led multicourant variable DALI DC		5	19,14 €
	MIM-12D 700mA 12W		10	17,39 €
	ECO ERP Design. Constant multi-current output from 100mA to 700mA. Dimmable DALI and PUSH		50	16,25 €
	Length (mm): 65 Width (mm): 43 High (mm): 24 Colour: White Voltage In (Vac): 220~240 Voltage Out (Vdc): 2~42 Intensidad Out (A): 0.1~0.7 Frecuency (Hz): 50~60 Power (W): 4.2~12.6 Room Temperature (°C): -20~+60 Critical Temperature (°C): 90 Life (Hours): 50000 Ingress Protection: IP20 Dimmable: Push&DALI Power factor: 0.95			



Subfamily **Electronic Led power dimmable constant current**

Picture	Article	Description	Lot	Price/Unit
	G503712C		1	22,17 €
	Power supply Led multicourant variable DALI DC		5	20,16 €
	EUM-12D 700mA 12W		10	18,33 €
			50	17,13 €
	ECO ERP Design. Constant multi-current output from 150mA to 700mA. Dimmable DALI DT6			
	Length (mm): 127 Width (mm): 30 High (mm): 20 Colour: White Voltage In (Vac): 220~240 Voltage Out (Vdc): 2~42 Intensidad Out (A): 0.15~0.7 Frecuency (Hz): 50~60 Power (W): 6.3~11.9 Room Temperature (°C): -20~+45 Critical Temperature (°C): 90 Life (Hours): 50000 Ingress Protection: IP20 Dimmable: Push&DALI Power factor: 0.95			



	G503515		1	15,96 €
	LED Power Supply dimmable SLD15-300IL-Es		5	13,31 €
	300mA 14,4W		10	12,09 €
			80	11,31 €
	ECO Design ERP Compliant. Dimmable with leading or trailing edge dimmers. Constant current output 300mA.			
	Length (mm): 85,3 Width (mm): 41 High (mm): 22 Colour: White Voltage In (Vac): 220~240 Voltage Out (Vdc): 24~48 Intensidad Out (A): 0.3 Frecuency (Hz): 50~60 Power (W): 7.2~14.4 Room Temperature (°C): -25~+50 Critical Temperature (°C): 85 Ingress Protection: IP20 Dimmable: Corte inicio o fin de fase Power factor: 0.95			



Subfamily **Electronic Led power dimmable constant current**

Picture	Article	Description	Lot	Price/Unit
	G503515B		1	15,96 €
	LED Power Supply dimmable SLD15-350IL-Es		5	13,31 €
	350mA 14,7W		10	12,09 €
			80	11,31 €

ECO Design ERP Compliant. Adjustable 10-100% with regulators cutting start or end of phase. Constant current output 350mA. Independant use.

Length (mm): 85,3 Width (mm): 41 High (mm): 22
 Colour: White Voltage In (Vac): 220~240
 Voltage Out (Vdc): 24~42 Intensidad Out (A): 0.35
 Frecuency (Hz): 50~60 Power (W): 8.4~14.7
 Room Temperature (°C): -25~+50
 Critical Temperature (°C): 85 Ingress Protection: IP20
 Dimmable: Corte inicio o fin de fase
 Power factor: 0.95



	G503515D		1	15,96 €
	LED Power Supply dimmable SLD15-500IL-Es		5	13,31 €
	500mA 15W		10	12,09 €
			80	11,31 €

ECO Design ERP Compliant. Adjustable 10-100% with regulators cutting start or end of phase. Constant current output 500mA. Independant use.

Length (mm): 85,3 Width (mm): 41 High (mm): 22
 Colour: White Voltage In (Vac): 220~240
 Voltage Out (Vdc): 17~30 Intensidad Out (A): 0.5
 Frecuency (Hz): 50~60 Power (W): 8.5~15
 Room Temperature (°C): -25~+50
 Critical Temperature (°C): 85 Ingress Protection: IP20
 Dimmable: Corte inicio o fin de fase
 Power factor: 0.95



Subfamily **Electronic Led power dimmable constant current**

Picture	Article	Description	Lot	Price/Unit
	G503515F		1	15,96 €
	LED Power Supply dimmable SLD15-700IL-Es		5	13,31 €
	700mA 15,4W		10	12,09 €
			80	11,31 €

ECO Design ERP Compliant. Adjustable 10-100% with regulators cutting start or end of phase. Constant current output 700mA. Independant use

Length (mm): 85,3 Width (mm): 41 High (mm): 22
 Colour: White Voltage In (Vac): 220~240
 Voltage Out (Vdc): 9~22 Intensidad Out (A): 0.7
 Frecuency (Hz): 50~60 Power (W): 6.3~15.4
 Room Temperature (°C): -25~+50
 Critical Temperature (°C): 85 Ingress Protection: IP20
 Dimmable: Corte inicio o fin de fase
 Power factor: 0.95



	G503520		1	17,33 €
	LED Power Supply CC dimmable SLD20-350IL-Es		5	14,44 €
	350mA 18,9W		10	13,12 €
			100	12,26 €

ECO Design ERP Compliant. Dimmable 10-100% with leading or trailing edge dimmers. Constant current output 350mA.

Length (mm): 121 Width (mm): 45 High (mm): 20
 Colour: White Voltage In (Vac): 220~240
 Voltage Out (Vdc): 30~54 Intensidad Out (A): 0.35
 Frecuency (Hz): 50~60 Power (W): 10.5~18.9
 Room Temperature (°C): -20~+40
 Critical Temperature (°C): 90 Ingress Protection: IP20
 Dimmable: Corte inicio o fin de fase
 Power factor: 0.95



Subfamily **Electronic Led power dimmable constant current**

Picture	Article	Description	Lot	Price/Unit
	GTC18350		1	17,00 €
	Led Driver CC MINI MD 350mA 18W		5	15,46 €
			10	14,05 €
	ECO ERP directives. 350mA constant current output power supply. Dimmable leading and trailing edge dimmers.		50	13,01 €
	Length (mm): 115 Width (mm): 52 High (mm): 22 Voltage In (Vac): 220~240 Voltage Out (Vdc): 25~51 Intensidad Out (A): 0.35 Frecuency (Hz): 50~60 Power (W): 8.75~18 Room Temperature (°C): -25~+50 Critical Temperature (°C): 75 Ingress Protection: IP20 Dimmable: Corte inicio o fin de fase Power factor: 0.95 Reference: 127030			



	G503520A		1	17,33 €
	LED Power Supply CC dimmable SLD20-500IL-Es 500mA 20W		5	14,44 €
			10	13,12 €
	ECO Design ERP Compliant. Dimmable 10-100% with leading or trailing edge dimmers. Constant current output 500mA.		100	12,26 €
	Length (mm): 121 Width (mm): 45 High (mm): 20 Colour: White Voltage In (Vac): 220~240 Voltage Out (Vdc): 20~40 Intensidad Out (A): 0.5 Frecuency (Hz): 50~60 Power (W): 10~20 Room Temperature (°C): -20~+40 Critical Temperature (°C): 90 Ingress Protection: IP20 Dimmable: Corte inicio o fin de fase Power factor: 0.95			



Subfamily **Electronic Led power dimmable constant current**

Picture	Article	Description	Lot	Price/Unit
	G503520B		1	17,33 €
	LED Power Supply CC dimmable SLD20-700IL-Es		5	14,44 €
	700mA 20,3W		10	13,12 €
	ECO Design ERP Compliant. Dimmable 10-100% with leading or trailing edge dimmers. Constant current output 700mA.		100	12,26 €
	Length (mm): 121 Width (mm): 45 High (mm): 20 Colour: White Voltage In (Vac): 220~240 Voltage Out (Vdc): 15~29 Intensidad Out (A): 0.7 Frecuency (Hz): 50~60 Power (W): 10.5~20.3 Room Temperature (°C): -20~+40 Critical Temperature (°C): 90 Ingress Protection: IP20 Dimmable: Corte inicio o fin de fase Power factor: 0.95			



Subfamily **Electronic Led power dimmable constant current**

Picture	Article	Description	Lot	Price/Unit
	G503520E		1	32,46 €
	LED Power Supply CC Dimmable 0/1-10V		5	29,51 €
	SLD20-500ILA-UN1 up to 500mA 20W		10	26,83 €
	ECO Design ERP Compliant. Dimmable 1-100% with 0 / 1-10V signal. Multi-current output 150-500mA dip-switch.		100	25,08 €
	Length (mm): 103,1 Width (mm): 41 High (mm): 22 Colour: White Voltage In (Vac): 110~277 Voltage Out (Vdc): 20~40 Intensidad Out (A): 0.15~0.5 Frecuency (Hz): 50~60 Power (W): 2.8~20 Room Temperature (°C): -20~+50 Critical Temperature (°C): 85 Life (Hours): 50000 Ingress Protection: IP20 Dimmable: 0-10V Power factor: 0.95			

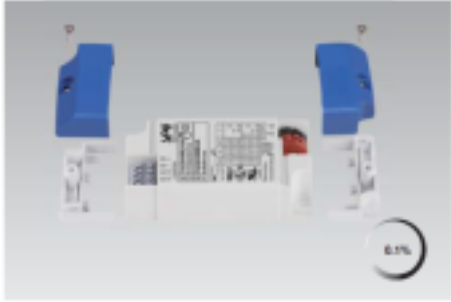

Subfamily **Electronic Led power dimmable constant current**

Picture	Article	Description	Lot	Price/Unit
	G503620		1	34,31 €
	Led power CC Dimmable DALI SLD20-500IBD-UN		5	30,65 €
	hasta 500mA 20W		10	27,87 €
	ECO Design ERP.To incorporate. Adjustable DALI or PUSH DIM. Output to constant current selectable from 150mA to 500mA per DIP switch.		100	26,05 €
	Length (mm): 78,7 Width (mm): 41 High (mm): 22 Colour: White Voltage In (Vac): 110~277 Voltage Out (Vdc): 27~40 Intensidad Out (A): 0.15~0.5 Frecuency (Hz): 50~60 Power (W): 4~20 Room Temperature (°C): -25~+50 Critical Temperature (°C): 90 Ingress Protection: IP20 Dimmable: DALI Power factor: 0.84-0.95			



Subfamily **Electronic Led power dimmable constant current**

Picture	Article	Description	Lot	Price/Unit
	G503620A		1	37,23 €
	Led power CC Dimmable DALI SLD20-500ILD-UN		5	33,85 €
	hasta 500mA 20W		10	30,77 €
	ECO Design ERP Compliant. Independent use.		100	28,77 €
	Adjustable DALI2. Constant current output selectable from 150mA to 500mA by DIP switch.			
	Length (mm): 103,1 Width (mm): 41 High (mm): 22 Colour: White Voltage In (Vac): 110~277 Voltage Out (Vdc): 8~40 Intensidad Out (A): 0.15~0.5 Frecuency (Hz): 50~60 Power (W): 4~20 Room Temperature (°C): -20~+50 Critical Temperature (°C): 90 Ingress Protection: IP20 Dimmable: DALI Power factor: 0.94-0.95			



	G503720B		1	22,58 €
	Dimmable LED power supply DALI CC MIM-20D		5	20,53 €
	multi-corriente 700mA 20W		10	18,66 €
	ECO ERP Design. Constant multi-current output from 300mA to 700mA. Dimmable DALI and PUSH		50	17,43 €
	Length (mm): 85 Width (mm): 43 High (mm): 23 Colour: White Voltage In (Vac): 220~240 Intensidad Out (A): 0.3~0.7 Frecuency (Hz): 50~60 Power (W): 12.6~20 Room Temperature (°C): -20~+60 Critical Temperature (°C): 90 Life (Hours): 50000 Ingress Protection: IP20 Dimmable: Push&DALI Power factor: 0.95			



Subfamily **Electronic Led power dimmable constant current**

Picture	Article	Description	Lot	Price/Unit
	GTC20500		1	17,34 €
	Led Driver CC MINI MD 500mA 20W		5	15,76 €
			10	14,33 €
	ECO ERP directives. 500mA constant current output power supply. Dimmable leading and trailing edge dimmers.		50	13,27 €
	Length (mm): 111 Width (mm): 52 High (mm): 22 Voltage In (Vac): 220~240 Voltage Out (Vdc): 16~42 Intensidad Out (A): 0.5 Frecuency (Hz): 50~60 Power (W): 20 Room Temperature (°C): -25~+45 Critical Temperature (°C): 75 Ingress Protection: IP20 Dimmable: Corte inicio o fin de fase Power factor: 0.95			
Reference: 127032				



Subfamily **Electronic Led power dimmable constant current**

Picture	Article	Description	Lot	Price/Unit
	GTC2070A		1	34,57 €
	Led Driver CV CC DIM MINI JOLLY DALI		5	31,43 €
	multi-current 700mA 20W		10	28,57 €
	ECO ERP Directives. DALI dimmable. Output current selectable by DIP-SWITCH from 250mA to 700mA and at constant voltage 24Vdc		50	26,46 €
	Length (mm): 111 Width (mm): 52 High (mm): 22 Voltage In (Vac): 110~240 Intensidad Out (A): 0.25~0.7 Frecuency (Hz): 50~60 Power (W): 1~20 Room Temperature (°C): -25~+45 Critical Temperature (°C): 75 Ingress Protection: IP20 Dimmable: DALI Power factor: 0.95			

Reference: 125403



Subfamily **Electronic Led power dimmable constant current**

Picture	Article	Description	Lot	Price/Unit
	GTC2070B		1	17,00 €
	Led Driver CC MINI MD 700mA 20W		5	15,46 €
			10	14,05 €
	ECO ERP directives. 700mA constant current output power supply. Dimmable leading and trailing edge dimmers.		50	13,01 €
		Length (mm): 115 Width (mm): 52 High (mm): 22 Voltage In (Vac): 220~240 Voltage Out (Vdc): 16~28 Intensidad Out (A): 0.7 Frecuency (Hz): 50~60 Power (W): 11.2~19.6 Room Temperature (°C): -25~+45 Critical Temperature (°C): 75 Ingress Protection: IP20 Dimmable: Corte inicio o fin de fase Power factor: 0.95		
	Reference: 127034			



Subfamily **Electronic Led power dimmable constant current**

Picture	Article	Description	Lot	Price/Unit
	GTC20900		1	33,45 €
	Led Driver CV CC DIM 1-10V-P MINI JOLLY		5	30,41 €
	multicurrent 900mA 20W		10	27,64 €
	ECO ERP Directives. Dimmable 1-10V. Output current selectable by DIP-SWITCH from 250mA to 900mA and at constant voltage 12 and 24Vdc		50	25,60 €
	Length (mm): 111 Width (mm): 52 High (mm): 22 Voltage In (Vac): 110~240 Intensidad Out (A): 0.25~0.9 Frecuency (Hz): 50~60 Power (W): 1~20 Room Temperature (°C): -25~+50 Critical Temperature (°C): 80 Ingress Protection: IP20 Dimmable: 1-10V Power factor: 0.95			
Reference: 125400				



Subfamily **Electronic Led power dimmable constant current**

Picture	Article	Description	Lot	Price/Unit
	GTC2090A		1	24,91 €
	Led Driver CV CC DIM MINI JOLLY MD multi-current		5	22,65 €
	900mA 20W		10	20,58 €
	ECO ERP Directives. Dimmable by leading or trailing edge phase cut. Output current selectable by DIP-SWITCH from 250mA to 900mA and at constant voltage 12 and 24Vdc		50	19,06 €
	Length (mm): 111 Width (mm): 52 High (mm): 22 Voltage In (Vac): 220~240 Intensidad Out (A): 0.25~0.9 Frecuency (Hz): 50~60 Power (W): 3~20 Room Temperature (°C): -25~+45 Critical Temperature (°C): 75 Ingress Protection: IP20 Dimmable: Corte inicio o fin de fase Power factor: 0.85			

Reference: 127556



LED TECHNOLOGY > Electronic Led Power Supplies > LED Power Supplies Constant Current

Subfamily **Electronic Led power dimmable constant current**

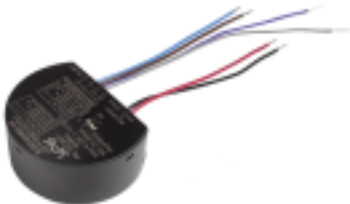
Picture	Article	Description	Lot	Price/Unit
	G503623A		1	38,45 €
	Dimmable DC Led Power Supply DALI2		5	32,05 €
	SLD23-600IBD-UN up to 600mA 23W		10	29,13 €
	ECO ERP design. To incorporate. Dimmable DALI. DC output from 200 to 600mA with steps of 50mA.		50	26,98 €
	Length (mm): 64 Width (mm): 49,7 High (mm): 27 Colour: Black Voltage In (Vac): 120~240 Voltage Out (Vdc): 6~42 Frecuency (Hz): 50~60 Power (W): 4~23 Room Temperature (°C): -20~+50 Critical Temperature (°C): 90 Ingress Protection: IP20 Dimmable: DALI Power factor: 0.7-0.95			

SAIF



	G503525C		1	13,61 €
	Dimmable Led Power Supply CC NTF 350mA 25W		5	11,34 €
			10	10,32 €
	ECO Design ERP Compliant. Dimmable with leading and trailing edge dimmers. 350mA constant current output.		50	9,65 €
	Length (mm): 120 Width (mm): 45 High (mm): 28 Colour: White Voltage In (Vac): 220~240 Voltage Out (Vdc): 36~72 Intensidad In (A): 0.16 Intensidad Out (A): 0.35 Frecuency (Hz): 50~60 Power (W): 12.5~25 Room Temperature (°C): -20~+45 Critical Temperature (°C): 85 Life (Hours): 50000 Ingress Protection: IP20 Dimmable: Corte inicio o fin de fase Power factor: 0.95			

ACTEC®



LED TECHNOLOGY > Electronic Led Power Supplies > LED Power Supplies Constant Current

Subfamily **Electronic Led power dimmable constant current**

Picture	Article	Description	Lot	Price/Unit
	G503525D		1	13,61 €
	Led Power Supply dimmable CC NTF 500mA 25W		5	11,34 €
			10	10,32 €
	ECO Design ERP Compliant. Dimmable with leading or trailing edge dimmers . Constant current output 500mA.		50	9,65 €
	Length (mm): 120 Width (mm): 45 High (mm): 28 Colour: White Voltage In (Vac): 220~240 Voltage Out (Vdc): 25~50 Intensidad In (A): 0.16 Intensidad Out (A): 0.5 Frecuency (Hz): 50~60 Power (W): 12.6~25 Room Temperature (°C): -20~+45 Critical Temperature (°C): 85 Life (Hours): 50000 Ingress Protection: IP20 Dimmable: Corte inicio o fin de fase Power factor: 0.95			





LED TECHNOLOGY > Electronic Led Power Supplies > LED Power Supplies Constant Current



Subfamily **Electronic Led power dimmable constant current**

Picture	Article	Description	Lot	Price/Unit
	G503525E		1	13,61 €
	Led Power Supply dimmable CC NTF 700mA 25W		5	11,34 €
			10	10,32 €
	ECO Design ERP Compliant. Dimmable with leading or trailing edge dimmers . Constant current output 700mA.		50	9,65 €
	Length (mm): 120 Width (mm): 45 High (mm): 28 Colour: White Voltage In (Vac): 220~240 Voltage Out (Vdc): 18~36 Intensidad In (A): 0.16 Intensidad Out (A): 0.7 Frecuency (Hz): 50~60 Power (W): 12.6~25 Room Temperature (°C): -20~+45 Critical Temperature (°C): 85 Life (Hours): 50000 Ingress Protection: IP20 Dimmable: Corte inicio o fin de fase Power factor: 0.95			



Subfamily **Electronic Led power dimmable constant current**

Picture	Article	Description	Lot	Price/Unit
	G503530		1	19,93 €
	LED Power Supply dimmable SLD30-500IL-Es		5	18,11 €
	500mA 30W		10	16,46 €
	ECO Design ERP Compliant. Dimmable 10-100% with leading or trailing edge dimmers. Constant current output 500mA.		50	15,39 €
	Length (mm): 165 Width (mm): 40 High (mm): 30 Colour: White Voltage In (Vac): 220~240 Voltage Out (Vdc): 30~60 Intensidad Out (A): 0.5 Frecuency (Hz): 50~60 Power (W): 15~30 Room Temperature (°C): -20~+40 Critical Temperature (°C): 75 Ingress Protection: IP20 Dimmable: Corte inicio o fin de fase Power factor: 0.9			
				
				

	G503530A		1	19,93 €
	LED Power Supply dimmable SLD30-600IL-Es		5	18,11 €
	600mA 30W		10	16,46 €
	ECO Design ERP Compliant. Dimmable 10-100% with leading or trailing edge dimmers. Constant current output 600mA.		50	15,39 €
	Length (mm): 165 Width (mm): 40 High (mm): 30 Colour: White Voltage In (Vac): 220~240 Voltage Out (Vdc): 25~50 Intensidad Out (A): 0.6 Frecuency (Hz): 50~60 Power (W): 15~30 Room Temperature (°C): -20~+40 Critical Temperature (°C): 75 Ingress Protection: IP20 Dimmable: Corte inicio o fin de fase Power factor: 0.9			
				
				

Subfamily **Electronic Led power dimmable constant current**

Picture	Article	Description	Lot	Price/Unit
	G503830A		1	24,91 €
	Dimmable LED power supply DALI CC MIM-30D		5	22,65 €
	multi-corriente 1050mA30W		10	20,59 €
			50	19,24 €
	ECO ERP Design. Constant multi-current output from 500mA to 1050mA. Dimmable DALI and PUSH			
	Length (mm): 93 Width (mm): 55 High (mm): 32 Colour: White Voltage In (Vac): 220~240 Intensidad Out (A): 0.5~1.05 Frecuency (Hz): 50~60 Power (W): 20~29.2 Room Temperature (°C): -20~+60 Critical Temperature (°C): 90 Life (Hours): 50000 Ingress Protection: IP20 Dimmable: Push&DALI Power factor: 0.95			



	GTC3270A		1	37,06 €
	Led Driver CV CC DIM JOLLY DALI multi-current		5	33,70 €
	700mA 32W		10	30,65 €
			50	28,37 €
	ECO ERP Directives. DALI dimmable. Output current selectable by DIP-SWITCH from 250mA to 700mA and at constant voltage 12 and 24Vdc			
	Length (mm): 103 Width (mm): 67 High (mm): 21 Voltage In (Vac): 110~240 Intensidad Out (A): 0.25~0.7 Frecuency (Hz): 50~60 Power (W): 1~32 Room Temperature (°C): -25~+50 Critical Temperature (°C): 75 Ingress Protection: IP20 Dimmable: DALI Power factor: 0.95 Reference: 125424			



Subfamily **Electronic Led power dimmable constant current**

Picture	Article	Description	Lot	Price/Unit
	GTC32900		1	39,08 €
	Led Driver CV CC DIM 1-10V-P JOLLY US		5	35,52 €
	multicurrent 900mA 32W		10	32,29 €
	ECO ERP Directives. Adjustable 1-10V. Output current selectable by DIP-SWITCH from 250mA to 900mA and at constant voltage 12 and 24Vdc		50	29,90 €
	Length (mm): 103 Width (mm): 67 High (mm): 21 Voltage In (Vac): 110~240 Intensidad Out (A): 0.25~0.9 Frecuency (Hz): 50~60 Power (W): 1~33 Room Temperature (°C): -25~+45 Critical Temperature (°C): 75 Ingress Protection: IP20 Dimmable: 1-10V Power factor: 0.95			
Reference: 126421				



LED TECHNOLOGY > Electronic Led Power Supplies > LED Power Supplies Constant Current

Subfamily **Electronic Led power dimmable constant current**

Picture	Article	Description	Lot	Price/Unit
	GTC3290A		1	40,69 €
	Led Driver CV CC DIM JOLLY MD multicurrent		5	37,00 €
	900mA 32W		10	33,63 €
			40	31,15 €
	ECO ERP Directives. DALI dimmable. Output current selectable by DIP-SWITCH from 350mA to 750mA			
	Length (mm): 166 Width (mm): 46 High (mm): 34 Voltage In (Vac): 220~240 Intensidad Out (A): 0.35~0.75 Frecuency (Hz): 50~60 Power (W): 0~32 Room Temperature (°C): -25~+45 Critical Temperature (°C): 75 Ingress Protection: IP20 Dimmable: Corte inicio o fin de fase Power factor: 0.97			
	Reference: 122260			



LED TECHNOLOGY > Electronic Led Power Supplies > LED Power Supplies Constant Current

Subfamily **Electronic Led power dimmable constant current**

Picture	Article	Description	Lot	Price/Unit
	G503635A		1	41,15 €
	LED Power Supply CC SLT351000ILD-UN DC power supply up to 1000mA		5	37,40 €
			10	34,01 €
			100	31,79 €
	ECO Design ERP Compliant. Independent use. Adjustable DALI or PUSH DIM. Output to constant current selectable from 250mA to 1000mA by DIP switch.			
	Length (mm): 139 Width (mm): 42 High (mm): 29,8 Colour: White Voltage In (Vac): 110~277 Voltage Out (Vdc): 8~42 Intensidad Out (A): 0.25~1 Frecuency (Hz): 50~60 Power (W): 5.2~35 Room Temperature (°C): -20~+50 Critical Temperature (°C): 90 Ingress Protection: IP20 Dimmable: DALI Power factor: 0.95			



LED TECHNOLOGY > Electronic Led Power Supplies > LED Power Supplies Constant Current

Subfamily **Electronic Led power dimmable constant current**

Picture	Article	Description	Lot	Price/Unit
	GTC381050		1	38,51 €
	Led Driver CC DIM PROFESSIONALE DALI		5	34,98 €
	multi-current 1050mA 38W		10	31,81 €
			40	29,45 €
	ECO ERP Directives. DALI dimmable. Output current selectable by DIP-SWITCH from 300mA to 1050mA			
	Length (mm): 146 Width (mm): 44 High (mm): 30 Voltage In (Vac): 220~240 Intensidad Out (A): 0.3~1.05 Frecuency (Hz): 50~60 Power (W): 3~38 Room Temperature (°C): -25~+45 Critical Temperature (°C): 85 Ingress Protection: IP20 Dimmable: DALI Power factor: 0.95 Reference: 127490			



Subfamily **Electronic Led power dimmable constant current**

Picture	Article	Description	Lot	Price/Unit
	G503540B		1	21,02 €
	LED Power Supply dimmable SLD40-900IL-Es		5	19,10 €
	900mA 39,6W		10	17,37 €
	ECO Design ERP Compliant. Dimmable 10-100% with leading or trailing edge dimmers. Constant current output 900mA.		50	16,24 €
	Length (mm): 165 Width (mm): 40 High (mm): 30 Colour: White Voltage In (Vac): 220~240 Voltage Out (Vdc): 22~44 Intensidad Out (A): 0.9 Frecuency (Hz): 50~60 Power (W): 19.8~39.6 Room Temperature (°C): -20~+40 Critical Temperature (°C): 75 Ingress Protection: IP20 Dimmable: Corte inicio o fin de fase Power factor: 0.90			



	A491820		1	45,12 €
	Led Driver CC DIM JOLLY DALI 2 PUSH multicurrent		5	41,00 €
	1050mA 40W		15	37,38 €
	ECO ERP Directives. DALI and Push dimmable. Output current selectable by DIP-SWITCH from 300mA to 1050mA		45	35,01 €
	Length (mm): 119 Width (mm): 67 High (mm): 24 Voltage In (Vac): 220~240 Intensidad Out (A): 0.3~1.05 Frecuency (Hz): 50~60 Power (W): 12~42 Room Temperature (°C): +50 Critical Temperature (°C): 85 Ingress Protection: IP20 Dimmable: Push&DALI			



LED TECHNOLOGY > Electronic Led Power Supplies > LED Power Supplies Constant Current

Subfamily **Electronic Led power dimmable constant current**

Picture	Article	Description	Lot	Price/Unit
	G503540H		1	17,99 €
	Led Power Supply dimmable CC NTF 700mA 40W		5	14,99 €
	ECO Design ERP Compliant. Dimmable with leading or trailing edge dimmers . Constant current output 700mA.		10	13,62 €
			50	12,74 €
	Length (mm): 166 Width (mm): 52 High (mm): 24 Colour: White Voltage In (Vac): 220~240 Voltage Out (Vdc): 28~56 Intensidad In (A): 0.3 Intensidad Out (A): 0.7 Frecuency (Hz): 50~60 Power (W): 20~40 Room Temperature (°C): -20~+50 Critical Temperature (°C): 80 Life (Hours): 30000 Ingress Protection: IP20 Dimmable: Corte inicio o fin de fase Power factor: 0.95			



	G503840A		1	26,07 €
	Dimmable DALI DC MIM-30D multcurrent Led power supply 1200mA40W		5	23,70 €
	ECO ERP Design. Constant multi-current output from 700mA to 1200mA. Dimmable DALI and PUSH		10	21,54 €
			50	20,14 €
	Length (mm): 93 Width (mm): 55 High (mm): 32 Colour: White Voltage In (Vac): 220~240 Intensidad Out (A): 0.7~1.2 Frecuency (Hz): 50~60 Power (W): 29.4~40 Room Temperature (°C): -20~+60 Critical Temperature (°C): 90 Life (Hours): 50000 Ingress Protection: IP20 Dimmable: Push&DALI Power factor: 0.95			



LED TECHNOLOGY > Electronic Led Power Supplies > LED Power Supplies Constant Current

Subfamily **Electronic Led power dimmable constant current**

Picture	Article	Description	Lot	Price/Unit
	G503815A		1	45,60 €
	Dimmable DC Led Power Supply DALI2		5	38,00 €
	SLD45-1150IBD-UN up to 1150mA 45W		10	34,54 €
	ECO ERP design. To incorporate. DC output from 400 to 1150mA with steps of 50mA. Dimmable DALI		50	31,98 €
	Length (mm): 75,5 Width (mm): 56 High (mm): 30 Diameter (mm): 75,5 Colour: Black Voltage In (Vac): 120~240 Voltage Out (Vdc): 6~42 Frecuency (Hz): 50~60 Power (W): 4~45 Room Temperature (°C): -20~+50 Critical Temperature (°C): 90 Ingress Protection: IP20 Dimmable: DALI Power factor: 0.7-0.95			



	G503845A		1	22,89 €
	Dimmable Led driver DALI CC LC-45D multi current 45W		5	20,81 €
	SLR-2021 Compliant. Constant multi-current output from 350mA to 1050mA.		10	18,92 €
	Length (mm): 280 Width (mm): 31,5 High (mm): 22 Colour: White Voltage In (Vac): 220~240 Voltage Out (Vdc): 21~70 Intensidad Out (A): 0.7~1.05 Frecuency (Hz): 50~60 Power (W): 17.5~45 Room Temperature (°C): -20~+50 Critical Temperature (°C): 80 Life (Hours): 50000 Ingress Protection: IP20 Dimmable: DALI Power factor: 0.95		50	17,68 €



LED TECHNOLOGY > Electronic Led Power Supplies > LED Power Supplies Constant Current

Subfamily **Electronic Led power dimmable constant current**

Picture	Article	Description	Lot	Price/Unit
	G503845G		1	30,07 €
	Power supply Led multicourant variable DALI DC		5	27,34 €
	EUM-45D 1400mA 45W		10	24,86 €
	ECO ERP Design. Constant multi-current output from 700mA to 1400mA. Dimmable DALI DT6		50	23,23 €
	Length (mm): 137 Width (mm): 44 High (mm): 28 Colour: White Voltage In (Vac): 220~240 Voltage Out (Vdc): 10~42 Intensidad Out (A): 0.7~1.4 Frecuency (Hz): 50~60 Power (W): 29.4~44.8 Room Temperature (°C): -20~+45 Critical Temperature (°C): 90 Life (Hours): 50000 Ingress Protection: IP20 Dimmable: Push&DALI Power factor: 0.95			



LED TECHNOLOGY > Electronic Led Power Supplies > LED Power Supplies Constant Current

Subfamily **Electronic Led power dimmable constant current**

Picture	Article	Description	Lot	Price/Unit
	GTC601050		1	61,56 €
	Led Driver CC DIM MAXI JOLLY US DALI		5	55,97 €
	multi-current 1050mA 60W		10	50,87 €
			50	47,10 €
	ECO ERP Directives. DALI dimmable. Output current selectable by DIP-SWITCH from 350mA to 1050mA			
	Length (mm): 124 Width (mm): 79 High (mm): 22 Voltage In (Vac): 110~240 Intensidad Out (A): 0.35~1.05 Frecuency (Hz): 50~60 Power (W): 1~60 Room Temperature (°C): -25~+50 Critical Temperature (°C): 90 Ingress Protection: IP20 Dimmable: DALI Power factor: 0,95 Reference: 127413			



	GTC60105A		1	55,73 €
	Led Driver CC DIM 1-10V MAXI JOLLY US		5	50,66 €
	multicurrent 1050mA 60W		10	46,06 €
			50	42,65 €
	Length (mm): 111 Width (mm): 79 High (mm): 22 Voltage In (Vac): 110~240 Intensidad Out (A): 0.35~1.05 Frecuency (Hz): 50~60 Power (W): 1~60 Room Temperature (°C): -25~+50 Critical Temperature (°C): 90 Ingress Protection: IP20 Dimmable: 0/1-10V Power factor: 0.95 Reference: 127411			



Subfamily **Electronic Led power dimmable constant current**

Picture	Article	Description	Lot	Price/Unit
	G503875D		1	37,45 €
	Dimmable Led driver DALI CC LC-75D multi current		5	34,06 €
	75W		10	30,95 €
	SLR-2021 Compliant. Constant multi-current output from 1050mA to 1600mA.		50	28,93 €
	Length (mm): 360 Width (mm): 30 High (mm): 21 Colour: White Voltage In (Vac): 220~240 Voltage Out (Vdc): 23~71 Intensidad Out (A): 1.05~1.6 Frecuency (Hz): 50~60 Power (W): 26.3~75 Room Temperature (°C): -20~+50 Critical Temperature (°C): 80 Life (Hours): 50000 Ingress Protection: IP20 Dimmable: DALI Power factor: 0.95			



Catalogue **LED TECHNOLOGY**
 Line **Electronic Led Power Supplies**
 Family **LED Power Supplies Constant Current**
 Subfamily **Led power supplies constant current with dimmer**

Picture	Article	Description	Lot	Price/Unit
	A44720L		1	45,07 €
	Dimmable Led power supply CC RL4720/LED		5	34,67 €
	300mA-1050mA 14-40W black		10	33,01 €
	Led power supply and Dimmer with slider. Selectable constant current output with Dip-Switch		24	32,01 €
	Length (mm): 140 Width (mm): 88 High (mm): 36 Colour: Black Voltage In (Vac): 110~240 Voltage Out (Vdc): 46 Intensidad Out (A): 0.3~1.05 Frecuency (Hz): 50~60 Power (W): 14~40 Room Temperature (°C): 0~+35 Critical Temperature (°C): 85			



Catalogue **LED TECHNOLOGY**
 Line **Electronic Led Power Supplies**
 FAmily **LED Power Supplies Constant Current**
 Subfamily **Plug Led driver constant current**

Picture	Article	Description	Lot	Price/Unit
	G503117A1		1	30,65 €
	Pluggable led power supply dimable CC 350mA 8.4W		5	27,87 €
	plug EUR black		10	25,35 €
	Adjustable by push button NO in the secondary. 350mA constant current output .Class II		50	23,69 €
	Length (mm): 81 Width (mm): 66 High (mm): 24 Colour: Black Voltage In (Vac): 220~240 Voltage Out (V): 24 Intensidad Out (A): 0.35 Frecuency (Hz): 50~60 Power (W): 0~8.4 Room Temperature (°C): -20~+40 Critical Temperature (°C): 75 Life (Hours): 50000 Ingress Protection: IP20 Dimmable: Push Power factor: 0.6			

Reference: 039974



Subfamily **Plug Led driver constant current**

Picture	Article	Description	Lot	Price/Unit
	A415150S		1	45,11 €
	Dimmable Plug-in Led power supply EU+USA CC-CV		5	34,70 €
	RN1515/S 15W		10	33,10 €
			20	32,12 €
	Variable constant current output by Dip-Switch from 200mA to 950mA and at constant 12 or 24Vdc voltage. Powers from 8 to 15W. Dimmable in the secondary by means of a button. Too quiet.			
	Length (mm): 106 Width (mm): 49 High (mm): 36 Colour: Black Voltage In (Vac): 110~240 Voltage Out (Vdc): 12~24 Intensidad Out (A): 0.2~0.95 Frecuency (Hz): 50~60 Power (W): 10~15 Room Temperature (°C): +35 Critical Temperature (°C): 75 Ingress Protection: IP20 Dimmable: Push Power factor: >0.9			



Subfamily **Plug Led driver constant current**

Picture	Article	Description	Lot	Price/Unit
	G503517A		1	32,14 €
	Led Power Supply ALED CC A 17W - DC 350mA SP Negro		5	29,21 €
			10	26,56 €
			50	24,82 €
	Constant current, IP20, output section cable 2x0,75			
	Length (mm): 66 Width (mm): 24 High (mm): 81 Colour: Black Voltage In (Vac): 220~240 Voltage Out (Vdc): 12~46 Intensidad Out (A): 0.35 Frequency (Hz): 50~60 Power (W): 4.2~17 Room Temperature (°C): -20~+40 Critical Temperature (°C): 85 Ingress Protection: IP20 Dimmable: NO Power factor: 0.6 Reference: 035777			



	G503607A		1	34,63 €
	Plug-in power supply Led DC plug EUR 500mA 17W Black without cable		5	31,49 €
			10	28,61 €
			50	26,74 €
	Constant current 500mA. Voltage range 220-240 / 9-34VDC. Cable outlet section 2X0.75			
	Length (mm): 66 Width (mm): 24 High (mm): 81 Colour: Black Voltage In (Vac): 220~240 Voltage Out (Vdc): 9~34 Intensidad Out (A): 0.5 Frequency (Hz): 50~60 Power (W): 4.5~17 Room Temperature (°C): -20~+40 Critical Temperature (°C): 85 Ingress Protection: IP20 Dimmable: NO Power factor: 0.6 Reference: 035778			



Subfamily **Plug Led driver constant current**

Picture	Article	Description	Lot	Price/Unit
	G503717A		1	32,14 €
	Plug-in power supply Led DC plug EUR 700mA 17W		5	29,21 €
	Black without cable		10	26,56 €
	Constant current Cable outlet section 2X0.75		50	24,82 €
	Length (mm): 66 Width (mm): 24 High (mm): 81 Colour: Black Voltage In (Vac): 220~240 Voltage Out (Vdc): 6~24 Intensidad Out (A): 0.7 Frequency (Hz): 50~60 Power (W): 4.2~17 Room Temperature (°C): -20~+40 Critical Temperature (°C): 85 Ingress Protection: IP20 Dimmable: NO Power factor: 0.6			

Reference: 035779



Subfamily **Plug Led driver constant current**

Picture	Article	Description	Lot	Price/Unit
	G503118		1	49,74 €
	Dimable CC-CV plug-in LED power supply multi-pin		5	45,21 €
	18W black		10	41,11 €
	Dimable Push Output at voltage 12 or 24Vdc or current from 200mA to 950mA in 50mA jumps programmable by Dip-Switch. Exchangeable plug EU, US, UK, CN, AU, KR and JP. To be ordered separately.		50	38,42 €
	Length (mm): 122 Width (mm): 59 High (mm): 32 Colour: Black Voltage In (Vac): 100~240 Frecuency (Hz): 50~60 Power (W): 18 Room Temperature (°C): -20~+40 Critical Temperature (°C): 75 Life (Hours): 50000 Ingress Protection: IP20 Dimmable: Push Power factor: >0.95			

Reference: 040477



Subfamily **Plug Led driver constant current**

Picture	Article	Description	Lot	Price/Unit
	G5031180		1	125,96 €
	Dimable CC-CV plug-in LED power supply CASAMBI multi-pin 18W black		5	114,50 €
			10	104,10 €
	Dimmable with CASAMBI App and Push. Output 12 or 24Vdc or current from 200mA to 950mA in steps of 50mA programmable by Dip-Switch. Interchangeable plug EU, US, UK, CN, AU, KR and JP. Not included		50	97,31 €
	Length (mm): 122 Width (mm): 59 High (mm): 32 Colour: Black Voltage In (Vac): 100~240 Frecuency (Hz): 50~60 Power (W): 18 Room Temperature (°C): -20~+40 Critical Temperature (°C): 75 Life (Hours): 50000 Ingress Protection: IP20 Dimmable: Push Power factor: >0.95			

Reference: 040645



LED TECHNOLOGY > Electronic Led Power Supplies > LED Power Supplies Constant Current

Subfamily Plug Led driver constant current

Picture	Article	Description	Lot	Price/Unit
	G503118AU		1	3,09 €
	AU plug for dimmable plug-in LED power supply		5	2,57 €
	CC-CV 18W black		10	2,34 €
	AU plug -Australia adaptable to feeder G503118		50	2,18 €
	Colour: Black Critical Temperature (°C): 75			
	Reference: 401478			



	G503118CN		1	2,47 €
	CM plug for dimmable plug-in LED power supply		5	2,07 €
	CC-CV 18W black		10	1,87 €
	CN plug -China adaptable to feeder G503118		50	1,74 €
	Colour: Black Critical Temperature (°C): 75			
	Reference: 401477			



Subfamily Plug Led driver constant current

Picture	Article	Description	Lot	Price/Unit
	G503118EU		1	2,07 €
		EU plug for dimmable plug-in LED power supply	5	1,72 €
		CC-CV 18W black	10	1,56 €
		EU plug adaptable to feeder G503118	50	1,47 €
		Colour: Black Critical Temperature (°C): 75		
	Reference: 401474			



	G503118JP		1	2,47 €
		JP plug for dimmable plug-in LED power supply	5	2,07 €
		CC-CV 18W black	10	1,87 €
		JP-Japan plug adaptable to the G503118 feeder	50	1,74 €
		Colour: Black Critical Temperature (°C): 75		
	Reference: 401480			



Subfamily Plug Led driver constant current

Picture	Article	Description	Lot	Price/Unit
	G503118KR		1	3,25 €
	KR plug for dummy plug-in led feeder CC-CV 18W black		5	2,70 €
			10	2,47 €
	KR-Korea plug adaptable to the G503118 feeder		50	2,30 €
	Colour: Black Critical Temperature (°C): 75 Reference: 401479			



	G503118UK		1	3,25 €
	UK plug for dimmable plug-in LED power supply CC-CV 18W black		5	2,70 €
			10	2,47 €
	UK plug adaptable to the G503118 power supply		50	2,30 €
	Colour: Black Critical Temperature (°C): 75 Reference: 401476			



LED TECHNOLOGY > Electronic Led Power Supplies > LED Power Supplies Constant Current

Subfamily Plug Led driver constant current

Picture	Article	Description	Lot	Price/Unit
	G503118US		1	2,47 €
		US plug for dummy plug-in LED power supply CC-CV	5	2,07 €
		18W black	10	1,87 €
		US plug adaptable to the G503118 power supply	50	1,74 €
		Colour: Black Critical Temperature (°C): 75		
	Reference: 401475			

