



Catalogue **HALOTEC HARDWARE**  
 Line **Halotec Small Installation Material**  
 Family **Lampholders for Installing**  
 Subfamily **Halotec Installation Thermoplastic Lampholders E27**

Picture	Article	Description	Lot	Price/Unit
	AR1412031		1	1,52 €
	Lampholder for instalation 912/CP102 black thermoplastic T210°		50	0,74 €
		Installation lampholder with cap. Connetion by screws for rigid or flexible 0,5-2,5mm2 cables		500
		High (mm): 67 Diameter (mm): 38,5 Colour: Black Voltage In (Vac): 250 Intensidad In (A): 4 Temperature (°C): 210 Connection: Screw Socket: E27		
	Reference: 029582			





	AR1412032		1	1,52 €
	Lampholder for instalation 912/CP102 white thermoplastic T210°		50	0,74 €
		Installation lampholder with cap. Connetion by screws for rigid or flexible 0,5-2,5mm2 cables		500
		High (mm): 67 Diameter (mm): 38,5 Colour: White Voltage In (Vac): 250 Intensidad In (A): 4 Temperature (°C): 210 Connection: Screw Socket: E27		
	Reference: 029957			



Catalogue **HALOTEC HARDWARE**  
 Line **Halotec Small Installation Material**  
 Family **Lampholders for Installing**  
 Subfamily **Halotec thermoplastic Lampholders E27**

Picture	Article	Description	Lot	Price/Unit
	SK01001A		1	0,5910 €
	E27 black thermoplastic Lampholder mounted		250	0,5698 €
	M10x1.Conexión fixing screw			
	Colour: Black Voltage In (Vac): 250			
	Intensidad In (A): 4 Temperature (°C): 190			
	Reference: 039667			



	SK01003A		1	0,61 €
	E27 White thermoplastic Lampholder mounted		250	0,5699 €
	M10x1.Conexión fixing screw			
	Colour: White Voltage In (Vac): 250			
	Intensidad In (A): 4 Temperature (°C): 190			
	Reference: 039666			



Subfamily **Halotec thermoplastic Lampholders E27**

Picture	Article	Description	Lot	Price/Unit
	SK01009A		1	0,5968 €
		Half Threaded thermoplastic E27 lampholders black mounted no ring	250	0,5763 €
		M10x1.Conexión fixing screw		
		Colour: Black Voltage In (Vac): 250 Intensidad In (A): 4 Temperature (°C): 190  Reference: 040901		



	SK01011A		1	0,63 €
		Half Threaded thermoplastic E27 lampholders white mounted no ring	250	0,5929 €
		M10x1.Conexión fixing screw		
		Colour: White Voltage In (Vac): 250 Intensidad In (A): 4 Temperature (°C): 190  Reference: 040902		



Catalogue **HALOTEC HARDWARE**  
 Line **Halotec Small Installation Material**  
 Family **Lampholders for Installing**  
 Subfamily **Halotec Light point thermoplastic lampholders E27**

Picture	Article	Description	Lot	Price/Unit
	SK01054A		1	7,58 €
	E27 copper straight socket lamp holder		10	5,07 €
			50	4,69 €
	Thermoplastic. Automatic connection for rigid or flexible cables from 0.5 to 2.5mm2.		200	4,47 €
	High (mm): 58,2 Diameter (mm): 83 Colour: Copper Voltage In (Vac): 250 Temperature (°C): 180 Connection: Automatic Socket: E27			
	Reference: 041761			

arditi



	SK01055A		1	7,59 €
	E27 chrome straight socket lamp holder		10	5,08 €
			50	4,71 €
	Thermoplastic. Automatic connection for rigid or flexible cables from 0.5 to 2.5mm2.		200	4,49 €
	Colour: Chrome Voltage In (Vac): 250 Temperature (°C): 180 Connection: Automatic Socket: E27			
	Reference: 041762			

arditi



Subfamily **Halotec Light point thermoplastic lampholders E27**

Picture	Article	Description	Lot	Price/Unit
	SK01056A		1	7,59 €
	E27 Golden straight socket lamp holder		10	5,08 €
			50	4,71 €
	Thermoplastic. Automatic connection for rigid or flexible cables from 0.5 to 2.5mm2.		200	4,49 €
	High (mm): 58,2 Diameter (mm): 83 Colour: Gold Voltage In (Vac): 250 Temperature (°C): 180 Connection: Automatic Socket: E27			
	Reference: 041763			



	SK01038A		1	2,60 €
	White E27 curved base socket lamp holder		10	1,72 €
			50	1,59 €
	Thermoplastic. Connecting screws for rigid or flexible cables from 0.5 to 2.5mm2.		200	1,53 €
	Colour: White Voltage In (Vac): 250 Intensidad In (A): 4 Temperature (°C): 180 Connection: Automatic Socket: E27 Ingress Protection: IP20			
	Reference: 033801			



HALOTEC HARDWARE &gt; Halotec Small Installation Material &gt; Lampholders for Installing

Subfamily **Halotec Light point thermoplastic lampholders E27**

Picture	Article	Description	Lot	Price/Unit
	SK01039A		1	2,59 €
	Black E27 curved base socket lamp holder		10	1,73 €
	Thermoplastic. Automatic connection for rigid or flexible cables from 0.5 to 2.5mm2.		50	1,60 €
			200	1,53 €
	Colour: Black Voltage In (Vac): 250 Intensidad In (A): 4 Temperature (°C): 180 Connection: Automatic Socket: E27 Ingress Protection: IP20  Reference: 033802			



 arditi  
 LIGHTING INNOVATION

	SK01041A		1	2,12 €
	Lampholder for plinth straight E27 white ARDITI		10	1,42 €
	Thermoplastic. Connecting screws for rigid or flexible cables 0.5 to 2.5mm2		50	1,31 €
			200	1,26 €
	Colour: White Voltage In (Vac): 250 Intensidad In (A): 4 Temperature (°C): 180 Connection: Automatic Socket: E27 Ingress Protection: IP20  Reference: 033804			

 arditi  
 LIGHTING INNOVATION

HALOTEC HARDWARE > Halotec Small Installation Material > Lampholders for Installing

Subfamily **Halotec Light point thermoplastic lampholders E27**

Picture	Article	Description	Lot	Price/Unit
	SK01042A		1	2,21 €
	Black E27 straight base socket lamp holder		10	1,48 €
	Thermoplastic. Connecting screws for rigid or flexible cables 0.5 to 2.5mm2		50	1,35 €
			200	1,31 €
	Colour: Black Voltage In (Vac): 250 Intensidad In (A): 4 Temperature (°C): 180 Connection: Automatic Socket: E27 Ingress Protection: IP20 Reference: 033805			



Catalogue **HALOTEC HARDWARE**  
 Line **Halotec Small Installation Material**  
 Family **Lampholders for Installing**  
 Subfamily **Halotec Metal Lampholders E27**

Picture	Article	Description	Lot	Price/Unit
	SK01027		1	2,82 €
		Lampholder metallic E27 with shade ring	20	2,18 €
		Fixing M10x1 : metal screw with anti-rotation	60	1,98 €
		Colour: Zinc Voltage In (Vac): 250 Intensidad In (A): 4 Temperature (°C): 230 Connection: Screw Socket: E27		

arditi



	SK01027A		50 (Pedido mínimo)	1,95 €
		hreaded lampholder E27 galvanized metal mounted without washer	250	1,86 €
		Fixing M10x1: metal with anti-twist screw. For rigid or flexible cables of 0.5-2.5mm2. Grounded  Colour: White zinc Voltage In (Vac): 250 Intensidad In (A): 4 Temperature (°C): 230 Connection: Screw Socket: E27		

arditi

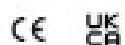



Subfamily **Halotec Metal Lampholders E27**

Picture	Article	Description	Lot	Price/Unit
	SK01028		1	3,81 €
		Blister Lampholder metallic E27 with shade ring	12	2,94 €
		Fixing M10x1: metal screw with anti-rotation.	24	2,67 €
		Colour: Zinc Voltage In (Vac): 250 Intensidad In (A): 4 Temperature (°C): 230 Connection: Screw Socket: E27		



	SK01028A		500 (Pedido mínimo)	2,38 €
		E27 threaded socket brass metal washer mounted without washer		
		M10x1 fixing: metal with anti-rotation screw. For rigid or flexible cables of 0.5-2.5mm <sup>2</sup> . With earth connection		
		Colour: Brass Voltage In (Vac): 250 Intensidad In (A): 4 Temperature (°C): 230 Connection: Screw Socket: E27  Reference: 035344		

Image in another color





Subfamily **Halotec Metal Lampholders E27**

Picture	Article	Description	Lot	Price/Unit
	SK01029A		1	2,56 €
	E27 smooth brass metal mounted		250	2,42 €
		M10x1 fixing: metal with anti-rotation screw. For rigid or flexible cables of 0.5-2.5mm2. With earth connection		
		Colour: Brass Voltage In (Vac): 250 Intensidad In (A): 4 Temperature (°C): 230 Connection: Screw Socket: E27		
		Reference: 035842		
				
				

	SK01030A		1	2,39 €
	Lampholder smooth metal zinc mounted E27		250	2,26 €
		M10x1 fixing: metal with anti-rotation screw. For rigid or flexible cables of 0.5-2.5mm2. With earth connection		
		Colour: White zinc Voltage In (Vac): 250 Intensidad In (A): 4 Temperature (°C): 230 Connection: Screw Socket: E27		
		Image in another color		
				
				

Catalogue **HALOTEC HARDWARE**  
 Line **Halotec Small Installation Material**  
 Family **Lampholders for Installing**  
 Subfamily **Halotec bakelite and thermoplastic Lampholders E14**

Picture	Article	Description	Lot	Price/Unit
	SK02001A		100 (Pedido mínimo)	0,4644 €
	Port. E14 smooth black thermoplastic mounted anti-rotation	M10x1 fixing. Screw connection	500	0,4472 €
		Colour: Black Voltage In (Vac): 250 Intensidad In (A): 2 Temperature (°C): 190 Socket: E14		
				
				

	SK02003A		100 (Pedido mínimo)	0,5820 €
	E14 smooth white thermoplastic lampholders mounted anti-rotation	M10x1.Conexión fixing screw	500	0,5625 €
		Colour: White Voltage In (Vac): 250 Intensidad In (A): 2 Temperature (°C): 190 Socket: E14		
		Reference: 031648		
				
				

**Subfamily Halotec bakelite and thermoplastic Lampholders E14**

Picture	Article	Description	Lot	Price/Unit
	SK02004		1	2,05 €
	Blister Lampholder plane E14 thermoplastic white antirotation		36	1,57 €
			72	1,42 €

Fixing M10x1: plastic screw with anti-rotation

Colour: White Voltage In (Vac): 250  
Intensidad In (A): 2 Temperature (°C): 190  
Connection: Screw Socket: E14



	SK02005		1	0,68 €
	Lampholder plane E14 bakelite black antirotation FILM+EAN		100	0,52 €
			500	0,47 €

Fixing M10x1 : metal screw with anti-rotation

Colour: Black Voltage In (Vac): 250  
Intensidad In (A): 2 Temperature (°C): 190  
Connection: Screw Socket: E14



HALOTEC HARDWARE > Halotec Small Installation Material > Lampholders for Installing

**Subfamily Halotec bakelite and thermoplastic Lampholders E14**

Picture	Article	Description	Lot	Price/Unit
	SK02006		1	0,75 €
	Blister Lampholder plane E14 bakelite black antirotation		36	0,57 €
			72	0,52 €

Fixing M10x1: metal screw with anti-rotation

Colour: Black Voltage In (Vac): 250  
Intensidad In (A): 2 Temperature (°C): 190  
Connection: Screw Socket: E14



	SK02007		1	0,70 €
	Smooth E14 lamp holder in white bakelite anti-rotation		100	0,52 €
			500	0,47 €



HALOTEC HARDWARE &gt; Halotec Small Installation Material &gt; Lampholders for Installing

Subfamily **Halotec bakelite and thermoplastic Lampholders E14**



Picture	Article	Description	Lot	Price/Unit
	SK02013		1	0,88 €
		Lampholder partly threaded E14 bakelite black	100	0,68 €
		antirotation FILM+EAN	500	0,61 €

Fixing M10x1 : metal screw with anti-rotation

Colour: Black Voltage In (Vac): 250  
 Intensidad In (A): 2 Temperature (°C): 190  
 Connection: Screw Socket: E14

Catalogue **HALOTEC HARDWARE**  
 Line **Halotec Small Installation Material**  
 Family **Lampholders for Installing**  
 Subfamily **Halotec Halogen Lampholders GZ10**

Picture	Article	Description	Lot	Price/Unit
	SK02027		1	1,01 €
	Lampholder halogen GZ10 230V		25	0,87 €
	Soapstone. Connection cable 15cm double silicone layer for high temperature		200	0,83 €
	Colour: Porcelain Voltage In (Vac): 250 Intensidad In (A): 4 Temperature (°C): 250-180 Socket: GZ10			
				

	SK02028		1	1,74 €
	Blister Lampholder halogen GZ10 230V		12	1,60 €
	Soapstone. Connection cable 15cm double silicone layer for high temperature		24	1,56 €
	Colour: Porcelain Voltage In (Vac): 250 Intensidad In (A): 4 Temperature (°C): 250-180 Socket: GZ10			
				

Catalogue **HALOTEC HARDWARE**  
 Line **Halotec Small Installation Material**  
 Family **Lampholders for Installing**  
 Subfamily **Halotec Halogen Low Voltage Lampholders**

Picture	Article	Description	Lot	Price/Unit
	SK02029		1	0,5855 €
	Lampholder halogen low voltage		50	0,4505 €
	Soapstone. Connection cable 16cm double silicone layer for high temperature		200	0,4053 €
	Colour: Ceramic Voltage In (Vdc/ac): 24 Intensidad In (A): 10 Temperature (°C): 300-180			



	SK02030		1	1,57 €
	Blister 2 units Lampholder halogen low voltage		12	1,26 €
	Soapstone. Connection cable 16cm double silicone layer for high temperature		24	1,14 €
	Colour: Ceramic Voltage In (Vdc/ac): 24 Intensidad In (A): 10 Temperature (°C): 300-180			





Catalogue **HALOTEC HARDWARE**  
 Line **Halotec Small Installation Material**  
 Family **Lampholders for Installing**  
 Subfamily **Lampholder adapter**

Picture	Article	Description	Lot	Price/Unit
	SK01045		1	1,50 €
	GU10/E27 adapter socket White		25	1,35 €
		Interior material: Ceramic. Outer material: Polyester	50	1,30 €
	High (mm): 57 Diameter (mm): 35 Colour: White Voltage In (Vac): 250 Intensidad In (A): 2 Socket: GU10			



Catalogue **HALOTEC HARDWARE**  
 Line **Halotec Small Installation Material**  
 Family **Lampholders for Installing**  
 Subfamily **Halotec lampholders and wreath accessories E27**



Picture	Article	Description	Lot	Price/Unit
	SK01046		1	1,30 €
		Lamp holder for garlands E27 socket black	10	1,20 €
		Thermostable material body (Polyamide). Connection by perforation, insulator (IP41 with washer ref. SK01050), for rectangular cable 5x11mm or 5.5x13mm, of section 2 x 2.5 mm <sup>2</sup> . Indoor use	50	1,13 €
		High (mm): 50 Diameter (mm): 40 Colour: Black Voltage In (Vac): 250 Intensidad In (A): 4 Power (W): 40 Socket: E27		

Image in another color



	SK01047		1	10,62 €
		Fixing bracket for rectangular cable 5x11mm	5	9,66 €
		Material synthetic rubber / Rubber.	10	9,20 €
		Length (mm): 113 Diameter (mm): 43 Colour: Black Ingress Protection: IP44		



Subfamily **Halotec lampholders and wreath accessories E27**

Picture	Article	Description	Lot	Price/Unit
	SK01048		1	11,06 €
	Bipolar plug for rectangular cable 5x11mm		5	10,05 €
	Material synthetic rubber / Rubber.		10	9,58 €

Length (mm): 99 Diameter (mm): 42 Colour: Black  
Voltage In (Vac): 250 Intensidad In (A): 16  
Ingress Protection: IP44



	SK01049		1	19,02 €
	Bipolar mobile rubber base for garland for rectangular cable 5x11mm		5	17,29 €
	Material synthetic rubber / Rubber.		10	16,47 €

Material synthetic rubber / Rubber.

Length (mm): 118 Diameter (mm): 50 Colour: Black  
Voltage In (Vac): 250 Intensidad In (A): 16  
Ingress Protection: IP44



Subfamily **Halotec lampholders and wreath accessories E27**

Picture	Article	Description	Lot	Price/Unit
	SK01050		1	0,78 €
		Silicone sealing washer for garland lampholder	10	0,71 €
		Material: Resistant silicone. Internal diameter 28mm. For garland lampholder	40	0,68 €
		High (mm): 9 Diameter (mm): 42 Colour: Black Ingress Protection: IP44		



	SK01051		1	102,86 €
		10m garland with 12 lampholder E27 rectangular cable 5x11mm	2	93,50 €
		5x11mm halogen-free rectangular PVC cable. 10m long wreath with 12 E27 lampholders, 1 plug and 1 support. 1kV insulation	4	89,05 €
		Length (mm): 10000 Colour: Black		



HALOTEC HARDWARE > Halotec Small Installation Material > Lampholders for Installing

Subfamily **Halotec lampholders and wreath accessories E27**

Picture	Article	Description	Lot	Price/Unit
	SK01052	5x11mm Rectalgar Cable for Garland	50 (Pedido mínimo)	2,35 €
		5x11mm halogen-free rectangular PVC cable. 1kV insulation	100	2,15 €
		Length (mm): 5000 Colour: Black Room Temperature (°C): -5~+70	150	2,04 €

