



Catalogue **ELECTRICAL EQUIPMENT**  
 Line **Pendants**  
 Family **Pendants E27**  
 Subfamily **E27 White Pendants and Accessories**

| Picture   | Article   | Description                                  | Lot  | Price/Unit |
|---|-----------|--|------|------------|
|  | AR2148002 |  | 1    | 0,74 €     |
|   |           | Intern cord grip SCPN                        | 50   | 0,4644 €   |
|   |           | For transparent round hose 2x0,75mm2         | 1000 | 0,1548 €   |
|   |           | Length (mm): 25 Width (mm): 18 Colour: White | 3000 | 0,1368 €   |

arditi

|   |           |   |     |        |
|---|-----------|---|-----|--------|
|  | AR4700802 |   | 1   | 5,01 € |
|   |           | Suspension SS27/81GTP/20/C2/73/80cm white       | 10  | 3,12 € |
|   |           | Without connection box. maximum weight 2.29 kg. | 75  | 2,44 € |
|   |           | wire 2x0.75mm2 H03VV-F.                         | 300 | 2,31 € |

Length (mm): 800 Colour: White Voltage In (Vac): 250  
 Temperature (°C): 180 Socket: E27

Reference: 022001

arditi



ELECTRICAL EQUIPMENT > Pendants > Pendants E27

Subfamily **E27 White Pendants and Accessories**

| Picture   | Article   | Description   | Lot | Price/Unit |
|---|-----------|---|-----|------------|
|  | AR4720802 |   | 1   | 5,20 €     |
|   |           | Suspension PNM27/81GTP/31/73/80cm white   | 10  | 3,25 €     |
|   |           | With strip connection. Class II. maximum weight 2.29 kg. Wire 2x0.75mm2 H03VV-F                             | 75  | 2,54 €     |
|   |           |   | 300 | 2,47 €     |
|   |           | Length (mm): 800 Colour: White Voltage In (Vac): 250 Temperature (°C): 180 Socket: E27<br>Reference: 024922 |     |            |



|   |           |   |     |        |
|---|-----------|---|-----|--------|
|  | AR4730802 |   | 1   | 5,63 € |
|   |           | Suspension PNS27A/81GTP/20/C2/73/80cm white   | 10  | 3,51 € |
|   |           | With connection box. Class II. maximum weight 2.29 kg. Wire 2x0.75mm2 H03VV-F                               | 75  | 2,72 € |
|   |           |   | 300 | 2,63 € |
|   |           | Length (mm): 800 Colour: White Voltage In (Vac): 250 Temperature (°C): 180 Socket: E27<br>Reference: 021061 |     |        |



ELECTRICAL EQUIPMENT > Pendants > Pendants E27

**Subfamily E27 White Pendants and Accessories**

| Picture   | Article   | Description   | Lot | Price/Unit |
|---|-----------|---|-----|------------|
|  | AR4740802 |   | 1   | 5,46 €     |
|   |           | Suspension PNM27/81GTP/31/C3/73/80cm white  | 10  | 3,39 €     |
|   |           | With connection box. Class II. maximum weight 2.29 kg. Wire 2x0.75mm2 H03VV-F                               | 75  | 2,65 €     |
|   |           |   | 300 | 2,55 €     |
|   |           | Length (mm): 800 Colour: White Voltage In (Vac): 250 Temperature (°C): 180 Socket: E27<br>Reference: 025150 |     |            |



|   |           |  |      |          |
|---|-----------|--|------|----------|
|  | AR4810012 |  | 1    | 0,5014 € |
|   |           | Dome E27G TP white   | 100  | 0,3134 € |
|   |           | Cap for 3 pieces thermoplastic lampholder. Presacable use with TPMS (AR2148002 Code)     | 500  | 0,2449 € |
|   |           |  | 1500 | 0,2375 € |
|   |           | High (mm): 33 Diameter (mm): 57 Colour: White Temperature (°C): 190<br>Reference: 018644 |      |          |



ELECTRICAL EQUIPMENT > Pendants > Pendants E27

Subfamily **E27 White Pendants and Accessories**



| Picture   | Article  | Description | Lot  | Price/Unit |
|---|--|-------------|------|------------|
|  | AR4810202  |             | 1    | 0,4863 €   |
|   | Dome CAL/2 white   |             | 100  | 0,3041 €   |
|   | Spherical plastic cap to cover the lampholders of hanging fixtures |             | 1000 | 0,2375 €   |
|   |  |             | 3000 | 0,2308 €   |
|   | Width (mm): 40 High (mm): 40 Diameter (mm): 60<br>Colour: White    |             |      |            |

Image in another color



|   |  |  |      |          |
|---|--|--|------|----------|
|  | AR4810302  |  | 1    | 0,3475 € |
|   | Dome CAL/3 white   |  | 100  | 0,2171 € |
|   | Spherical plastic cap to cover the lampholders of hanging fixtures |  | 1000 | 0,1697 € |
|   |  |  | 3000 | 0,1647 € |
|   | Width (mm): 40 High (mm): 40 Diameter (mm): 60<br>Colour: White    |  |      |          |

Reference: 013158

Image in another color



ELECTRICAL EQUIPMENT > Pendants > Pendants E27

Subfamily **E27 White Pendants and Accessories**

| Picture   | Article   | Description | Lot | Price/Unit |
|---|---|-------------|-----|------------|
|  | AR4822002   |             | 1   | 0,87 €     |
|   | Canopy RO/20 white  |             | 50  | 0,5408 €   |
|   | Rosone for suspension, for application in class II. Use in combination with protective enclosure in class II. |             | 200 | 0,4222 €   |
|   |   |             | 600 | 0,4102 €   |
|   | High (mm): 72 Diameter (mm): 68 Colour: White   |             |     |            |

Reference: 027246



|   |   |  |      |          |
|---|---|--|------|----------|
|  | AR4822102   |  | 1    | 0,79 €   |
|   | Canopy RO/21 white  |  | 50   | 0,4922 € |
|   | Ceiling rose for suspension, for class II applications, with M7x1 plastic screw locking device code AR5823012 not supplied. To be ordered apart |  | 200  | 0,3788 € |
|   |   |  | 1000 | 0,3678 € |
|   | High (mm): 70 Diameter (mm): 89 Colour: White   |  |      |          |

Reference: 023111



ELECTRICAL EQUIPMENT > Pendants > Pendants E27

Subfamily **E27 White Pendants and Accessories**

| Picture   | Article   | Description | Lot  | Price/Unit |
|---|---|-------------|------|------------|
|  | AR4822202   |             | 1    | 0,77 €     |
|   | Canopy RO/22 white  |             | 50   | 0,4837 €   |
|   |   |             | 200  | 0,3721 €   |
|   | Ceiling rose for suspension, for class II applications. Use in combination with class II protection strip. For 2x0.75mm2 and 3x0.75mm2 cables |             | 1000 | 0,3610 €   |
|   | High (mm): 70 Diameter (mm): 89 Colour: White<br>Reference: 023112  |             |      |            |



|   |   |  |     |          |
|---|---|--|-----|----------|
|  | AR4823002   |  | 1   | 0,3942 € |
|   | Canopy RO/30 White                                    |  | 250 | 0,3285 € |
|   |   |  | 500 | 0,3188 € |
|   | Floron For suspensions with screw M7. Screw AR5823012 |  |     |          |
|   | High (mm): 85 Diameter (mm): 130 Colour: White        |  |     |          |



ELECTRICAL EQUIPMENT > Pendants > Pendants E27

Subfamily **E27 White Pendants and Accessories**

| Picture   | Article  | Description | Lot  | Price/Unit |
|---|--|-------------|------|------------|
|  | AR4823102                                      |             | 1    | 0,90 €     |
|   | Canopy RO/31 white                             |             | 50   | 0,5611 €   |
|   | With blocking screw M7x1 (supplied separately) |             | 250  | 0,4382 €   |
|   | allows assembly Classe II                      |             | 1000 | 0,4256 €   |
|   | High (mm): 72 Diameter (mm): 110 Colour: White |             |      |            |
|   | Reference: 023108                              |             |      |            |



|  |                                     |  |     |        |
|--|-------------------------------------|--|-----|--------|
|  <p>Image in another color</p> | AR5641005                           |  | 1   | 4,32 € |
|  | Suspension PNSS27/81GTP/C3/73/100cm |  | 75  | 3,61 € |
|  | white-Green                         |  | 300 | 3,51 € |
|  | White-Green                         |  |     |        |

ELECTRICAL EQUIPMENT > Pendants > Pendants E27

Subfamily **E27 White Pendants and Accessories**

| Picture   | Article   | Description   | Lot  | Price/Unit |
|---|-----------|---|------|------------|
|  | AR5823012 |   | 1    | 0,2330 €   |
|   |           | Plastic screw M7x1 white  | 100  | 0,1456 €   |
|   |           | M7x1 screw for cable clamps BC02, BC10M, BC10F and canopies of hanging fixtures | 1000 | 0,0485 €   |
|   |           | Length (mm): 10 Colour: White   | 5000 | 0,0426 €   |
|   |           | Reference: 023107   |      |            |

**Image in another color**





Catalogue **ELECTRICAL EQUIPMENT**  
 Line **Pendants**  
 Family **Pendants E27**  
 Subfamily **E27 Black Pendants and Accessories**

| Picture   | Article   | Description                                  | Lot  | Price/Unit |
|---|-----------|--|------|------------|
|  | AR2148002 |  | 1    | 0,74 €     |
|   |           | Intern cord grip SCPN                        | 50   | 0,4644 €   |
|   |           | For transparent round hose 2x0,75mm2         | 1000 | 0,1548 €   |
|   |           | Length (mm): 25 Width (mm): 18 Colour: White | 3000 | 0,1368 €   |

arditi

|   |           |  |     |        |
|---|-----------|--|-----|--------|
|  | AR4710601 |  | 1   | 4,86 € |
|   |           | Suspension PNS27A/81GTP/20/73/60cm black   | 10  | 3,04 € |
|   |           | With connection box. Class II. maximum weight 2.29 kg. Wire 2x0.75mm2 H03VV-F          | 100 | 2,39 € |
|   |           | Length (mm): 600 Colour: Black Voltage In (Vac): 250 Temperature (°C): 180 Socket: E27 | 300 | 2,30 € |

Reference: 020691

Image in another color

arditi



ELECTRICAL EQUIPMENT > Pendants > Pendants E27

Subfamily **E27 Black Pendants and Accessories**

| Picture   | Article  | Description | Lot | Price/Unit |
|---|--|-------------|-----|------------|
|  | AR47M0801  |             | 1   | 5,14 €     |
|   | Pendant PNM27/81GTP/31/C3/73/80 cm black   |             | 10  | 3,21 €     |
|   | With strip connection. Class II. maximum weight 2.29 kg. Wire 2x0.75mm2 H03VV-F        |             | 75  | 2,51 €     |
|   |  |             | 300 | 2,43 €     |
|   | Length (mm): 800 Colour: Black Voltage In (Vac): 250 Temperature (°C): 180 Socket: E27 |             |     |            |
|   | Reference: 025152  |             |     |            |

Image in another color





|   |  |  |     |        |
|---|--|--|-----|--------|
|  | AR47S0801  |  | 1   | 6,24 € |
|   | Pendant PNSS27A/81GTP/32/C3/73/80 cm Black                                 |  | 10  | 3,91 € |
|   | With 80cm of cable.  |  | 75  | 3,06 € |
|   |  |  | 300 | 2,96 € |
|   | Length (mm): 800 Colour: Black Voltage In (Vac): 250 Temperature (°C): 180 |  |     |        |

Image in another color



ELECTRICAL EQUIPMENT > Pendants > Pendants E27

Subfamily **E27 Black Pendants and Accessories**

| Picture   | Article  | Description | Lot  | Price/Unit |
|---|--|-------------|------|------------|
|  | AR4810011  |             | 1    | 0,4984 €   |
|   | Dome E27G TP black   |             | 100  | 0,3116 €   |
|   | Cap for 3 pieces thermoplastic lampholder.   |             | 500  | 0,2435 €   |
|   | Presacable use with TPMS (AR2148002 Code)  |             | 1500 | 0,2362 €   |
|   | High (mm): 33 Diameter (mm): 57 Colour: Black<br>Temperature (°C): 190 Socket: E27 |             |      |            |

Reference: 018645

Image in another color



|   |  |  |      |          |
|---|--|--|------|----------|
|  | AR4810201  |  | 1    | 0,4863 € |
|   | Dome CAL/2 black   |  | 100  | 0,3041 € |
|   | Spherical plastic cap to cover the lampholders of hanging fixtures |  | 1000 | 0,2375 € |
|   |  |  | 3000 | 0,2308 € |
|   | Width (mm): 40 High (mm): 40 Diameter (mm): 60<br>Colour: Black    |  |      |          |



ELECTRICAL EQUIPMENT > Pendants > Pendants E27

**Subfamily E27 Black Pendants and Accessories**

| Picture   | Article  | Description | Lot  | Price/Unit |
|---|--|-------------|------|------------|
|  | AR4810301  |             | 1    | 0,3160 €   |
|   | Dome CAL/3 black   |             | 100  | 0,1976 €   |
|   | Spherical plastic cap to cover the lampholders of hanging fixtures |             | 1000 | 0,1543 €   |
|   | Width (mm): 40 High (mm): 40 Diameter (mm): 60<br>Colour: Black    |             | 3000 | 0,1498 €   |



|   |   |  |     |          |
|---|---|--|-----|----------|
|  | AR4822001   |  | 1   | 0,87 €   |
|   | Canopy RO / 20 black  |  | 50  | 0,5408 € |
|   | Rosone for suspension, for application in class II. Use in combination with protective enclosure in class II. |  | 200 | 0,4222 € |
|   | High (mm): 72 Diameter (mm): 68 Colour: Black<br>Reference: 027247  |  | 600 | 0,4102 € |

**Image in another color**



ELECTRICAL EQUIPMENT > Pendants > Pendants E27

Subfamily **E27 Black Pendants and Accessories**



| Picture   | Article  | Description | Lot  | Price/Unit |
|---|--|-------------|------|------------|
|  | AR4823101                                      |             | 1    | 0,90 €     |
|   | Canopy RO/31 black                             |             | 50   | 0,5611 €   |
|   | With blocking screw M7x1 (supplied separately) |             | 250  | 0,4382 €   |
|   | allows assembly Classe II                      |             | 1000 | 0,4256 €   |
|   | High (mm): 72 Diameter (mm): 110 Colour: Black |             |      |            |
|   | Reference: 023109                              |             |      |            |

Image in another color



|   |   |  |      |        |
|---|---|--|------|--------|
|  | AR4825301   |  | 1    | 4,59 € |
|   | Canopy RO/53 black  |  | 50   | 2,87 € |
|   | Thermoplastic. It is used with H03VV-F 2x0.75mm                     |  | 250  | 2,25 € |
|   | round hose. Includes fixing bracket, DAF-1 nut,                     |  | 1000 | 2,18 € |
|   | BC10M cable opening and connection strip. For class II applications |  |      |        |
|   | High (mm): 35,5 Diameter (mm): 106 Colour: Black                    |  |      |        |
|   | Reference: 042783   |  |      |        |



ELECTRICAL EQUIPMENT > Pendants > Pendants E27

Subfamily **E27 Black Pendants and Accessories**

| Picture   | Article   | Description | Lot  | Price/Unit |
|---|---|-------------|------|------------|
|  | AR4825302   |             | 1    | 4,59 €     |
|   | Canopy RO/53 white  |             | 50   | 2,87 €     |
|   | Thermoplastic. It is used with H03VV-F 2x0.75mm round hose. Includes fixing bracket, DAF-1 nut, BC10M cable opening and connection strip. For class II applications |             | 250  | 2,25 €     |
|   | High (mm): 35,5 Diameter (mm): 106 Colour: White  |             | 1000 | 2,18 €     |
|   | Reference: 042784   |             |      |            |



|   |   |  |      |          |
|---|---|--|------|----------|
|  | AR5823011   |  | 1    | 0,2431 € |
|   | Plastic screw M7x1 black  |  | 100  | 0,1520 € |
|   | M7x1 screw for cable clamps BC02, BC10M, BC10F and canopies of hanging fixtures |  | 1000 | 0,0506 € |
|   | Length (mm): 10 Colour: Black   |  | 5000 | 0,0447 € |
|   | Reference: 024035   |  |      |          |



Catalogue **ELECTRICAL EQUIPMENT**  
 Line **Pendants**  
 Family **Pendants E27**  
 Subfamily **E27 Gold Pendants and Accessories**

| Picture   | Article  | Description | Lot  | Price/Unit |
|---|--|-------------|------|------------|
|  | AR4810204  |             | 1    | 0,5834 €   |
|   | Dome CAL/2 gold  |             | 100  | 0,3645 €   |
|   | Spherical plastic cap to cover the lampholders of hanging fixtures |             | 1000 | 0,2846 €   |
|   |  |             | 3000 | 0,2765 €   |

Width (mm): 40 High (mm): 40 Diameter (mm): 60  
 Colour: Gold

Image in another color



|   |  |  |      |          |
|---|--|--|------|----------|
|  | AR4810304  |  | 1    | 0,3782 € |
|   | Dome CAL/3 gold  |  | 100  | 0,2363 € |
|   | Spherical plastic cap to cover the lampholders of hanging fixtures |  | 1000 | 0,1846 € |
|   |  |  | 3000 | 0,1791 € |

Width (mm): 40 High (mm): 40 Diameter (mm): 60  
 Colour: Gold

Image in another color



ELECTRICAL EQUIPMENT > Pendants > Pendants E27

Subfamily **E27 Gold Pendants and Accessories**

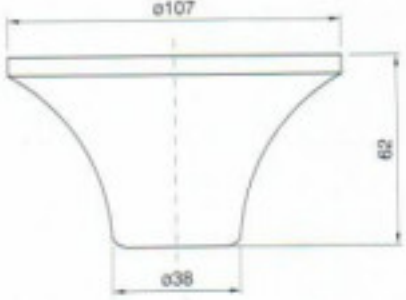
| Picture   | Article   | Description | Lot | Price/Unit |
|---|---|-------------|-----|------------|
|  | AR4820204                                       |             | 1   | 0,2107 €   |
|   | Canopy RO / 2 Gold                              |             | 250 | 0,1756 €   |
|   | Length (mm): 62 Diameter (mm): 107 Colour: Gold |             | 500 | 0,1704 €   |

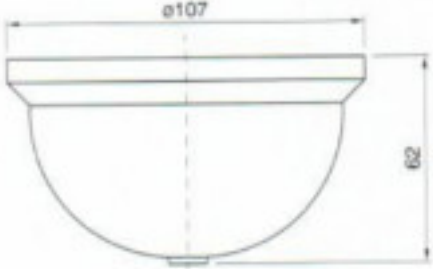

|   |   |  |     |          |
|---|---|--|-----|----------|
|  | AR4820304                                     |  | 1   | 0,4675 € |
|   | Canopy RO / 3 Gold                            |  | 350 | 0,3895 € |
|   | High (mm): 62 Diameter (mm): 107 Colour: Gold |  | 700 | 0,3782 € |





ELECTRICAL EQUIPMENT > Pendants > Pendants E27

Subfamily **E27 Gold Pendants and Accessories**

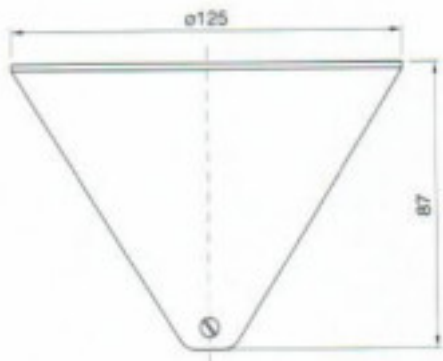
| Picture   | Article  | Description | Lot | Price/Unit |
|---|--|-------------|-----|------------|
|  | AR4823004                                      |             | 1   | 0,4729 €   |
|   | Canopy RO/30 gold                              |             | 250 | 0,3940 €   |
|   | Width (mm): 87 Diameter (mm): 125 Colour: Gold |             | 500 | 0,3826 €   |

|   |  |  |      |          |
|---|--|--|------|----------|
|  | AR4823104  |  | 1    | 1,07 €   |
|   | Canopy RO/31 gold  |  | 50   | 0,68 €   |
|   | With blocking screw M7x1 (supplied separately) allows assembly Classe II |  | 250  | 0,5295 € |
|   | High (mm): 72 Diameter (mm): 110 Colour: Gold                            |  | 1000 | 0,5144 € |

Reference: 024028

Image in another color

ELECTRICAL EQUIPMENT > Pendants > Pendants E27

Subfamily **E27 Gold Pendants and Accessories**

| Picture   | Article   | Description   | Lot  | Price/Unit |
|---|-----------|---|------|------------|
|  | AR5823014 |   | 1    | 0,3527 €   |
|   |           | Plastic screw M7x1 gold   | 100  | 0,2204 €   |
|   |           | M7x1 screw for cable clamps BC02, BC10M, BC10F and canopies of hanging fixtures | 1000 | 0,0733 €   |
|   |           | Length (mm): 10 Colour: Gold  | 5000 | 0,0647 €   |

Image in another color



Catalogue **ELECTRICAL EQUIPMENT**  
 Line **Pendants**  
 Family **Pendants E27**  
 Subfamily **E27 Transparent Pendants and Accessories**

| Picture   | Article   | Description | Lot | Price/Unit |
|---|---|-------------|-----|------------|
|  | AR5640803   |             | 1   | 8,67 €     |
|   | Suspension PNM27/81GTP/C3/73/80cm transparent                                     |             | 10  | 5,43 €     |
|   | With terminal block Class II. Maximum weight 2,29Kg. Cable H03VV-F 2x0.75         |             | 75  | 4,25 €     |
|   | Length (mm): 800 Section (mm2): 0,75<br>Colour: Transparent Voltage In (Vac): 250 |             | 150 | 4,07 €     |
|   | Reference: 024459   |             |     |            |

arditi



|   |  |  |     |        |
|---|--|--|-----|--------|
|  | AR5640806  |  | 1   | 7,32 € |
|   | Suspension PNM27/81GTP/C3/73/80cm transparent-blue                                     |  | 75  | 6,36 € |
|   | With terminal block Class II. Maximum weight 2,29Kg. Cable H03VV-F 2x0.75              |  | 300 | 6,14 € |
|   | Length (mm): 800 Section (mm2): 0,75<br>Colour: Transparent/Blue Voltage In (Vac): 250 |  |     |        |
|   |  |  |     |        |

arditi



ELECTRICAL EQUIPMENT > Pendants > Pendants E27

**Subfamily E27 Transparent Pendants and Accessories**

| Picture  | Article   | Description   | Lot | Price/Unit |
|--|-----------|---|-----|------------|
|  | AR5650803 |   | 1   | 6,57 €     |
|  |           | Suspension PNSS27/81GTP/20/73/80cm white, transparent cable               | 10  | 4,10 €     |
|  |           |   | 25  | 3,21 €     |
|  |           | With terminal block Class II. Maximum weight 2,29Kg. Cable H03VV-F 2x0.75 | 75  | 2,76 €     |
|  |           | Length (mm): 800 Section (mm2): 0,75 Colour: White Voltage In (Vac): 250  |     |            |



|   |           |  |      |        |
|---|-----------|--|------|--------|
|  | AR5823003 |  | 1    | 1,63 € |
|   |           | Canopy RO/31 transparent   | 10   | 1,03 € |
|   |           |  | 200  | 0,81 € |
|   |           | For hanging fixtures with M7x1 blocking screw (supplied separately)      | 1000 | 0,78 € |
|   |           | High (mm): 75 Diameter (mm): 110 Section (mm2): 0,75 Colour: Transparent |      |        |
|   |           | Reference: 027318  |      |        |

**Image in another color**



ELECTRICAL EQUIPMENT > Pendants > Pendants E27

**Subfamily E27 Transparent Pendants and Accessories**

| Picture   | Article   | Description | Lot  | Price/Unit |
|---|---|-------------|------|------------|
|  | AR5823013   |             | 1    | 0,5022 €   |
|   | Plastic screw M7x1 transparent  |             | 100  | 0,3138 €   |
|   | M7x1 screw for cable clamps BC02, BC10M, BC10F and canopies of hanging fixtures |             | 1000 | 0,1047 €   |
|   |   |             | 5000 | 0,0922 €   |
|   | Length (mm): 10 Colour: Transparent   |             |      |            |
|   | Reference: 025475   |             |      |            |

**Image in another color**



|   |                          |  |      |        |
|---|--------------------------|--|------|--------|
|  | AR5823103                |  | 1    | 0,73 € |
|   | Canopy RO/30 Transparent |  | 100  | 0,62 € |
|   | Colour: Transparent      |  | 1000 | 0,60 € |

**Image in another color**



Catalogue **ELECTRICAL EQUIPMENT**  
Line **Pendants**  
FAMILY **Pendants E27**  
Subfamily **E27 Blue Pendants and Accessories**

| Picture   | Article         | Description | Lot  | Price/Unit |
|---|-----------------|-------------|------|------------|
|  | AR5810306       |             | 1    | 0,1934 €   |
|   | Dome CAL/3 Blue |             | 100  | 0,1612 €   |
|   | Colour: Blue    |             | 1000 | 0,1565 €   |



Catalogue **ELECTRICAL EQUIPMENT**

Line **Pendants**

FAMILY **Pendants E27**

Subfamily **E27 Hanging Grey and Accessories**

| Picture   | Article                          | Description | Lot | Price/Unit |
|---|----------------------------------|-------------|-----|------------|
|  | AR5823000                        |             | 1   | 0,2365 €   |
|   | Dome RO/30 grey                  |             | 100 | 0,1971 €   |
|   | High (mm): 58 Diameter (mm): 130 |             | 250 | 0,1971 €   |

Image in another color



Catalogue **ELECTRICAL EQUIPMENT**

Line **Pendants**

FAMILY **Pendants E27**

Subfamily **E27 Orange Pendants Accessories**

| Picture  | Article           | Description | Lot  | Price/Unit |
|--|-------------------|-------------|------|------------|
|  | AR5810309         |             | 1    | 0,1934 €   |
|  | Dome CAL/3 Orange |             | 100  | 0,1612 €   |
|  | Colour: Orange    |             | 1000 | 0,1565 €   |

arditi



|   |                                  |  |      |        |
|---|----------------------------------|--|------|--------|
|  | AR5823109                        |  | 1    | 0,81 € |
|   | Canopy RO/30 Orange              |  | 100  | 0,68 € |
|   | High (mm): 85 Diameter (mm): 130 |  | 1000 | 0,65 € |

Image in another color

arditi



Catalogue **ELECTRICAL EQUIPMENT**  
Line **Pendants**  
FAMILY **Pendants E27**  
Subfamily **E27 Green Pendants and Accessories**

| Picture   | Article          | Description | Lot  | Price/Unit |
|---|------------------|-------------|------|------------|
|  | AR5810305        |             | 1    | 0,1934 €   |
|   | Dome CAL/3 Green |             | 100  | 0,1612 €   |
|   | Colour: Green    |             | 1000 | 0,1565 €   |

[Image in another color](#)



Catalogue **ELECTRICAL EQUIPMENT**

Line **Pendants**

FAMILY **Pendants E27**

Subfamily **E27 pendants with colour textile cable**

| Picture   | Article   | Description | Lot | Price/Unit |
|---|---|-------------|-----|------------|
|  | AR4521802   |             | 1   | 9,19 €     |
|   | Suspension  |             | 5   | 5,75 €     |
|   | PNM27/TES-GR/81GTP/31/C3/73/80/TR-BI 80cm textile white   |             | 50  | 4,59 €     |
|   |   |             | 250 | 4,37 €     |
|   | Hanging fixture with H03VV-F 2x0,75mm <sup>2</sup> textile cable, length 80cm Class.Maxi weight allowed 2,25Kg<br><br>Length (mm): 800 Width (mm): 30 High (mm): 25<br>Colour: White Voltage In (Vac): 250<br>Intensidad In (A): 4 Socket: E27<br><br>Reference: 032902 |             |     |            |

