

Catalogue **ELECTRICAL EQUIPMENT**

Line **Electronic Devices**

FAMILY **Regulators**

Subfamily **Hand Dimmers Ardití**

Picture	Article	Description	Lot	Price/Unit
	A40038T		1	11,64 €
	Dimmer CROSS F-RL0038 transparent		12	10,60 €
		Regulation with continuous pressure of push button. On-Off with fast pulsation. No cable	60	10,09 €

Length (mm): 76 Width (mm): 95 High (mm): 36
 Colour: Transparent Voltage In (Vac): 230
 Frequency (Hz): 50 Power (W): 40~300
 Ingress Protection: IP20



	A41621T		1	13,57 €
	Dimmer RTS1- RL1621 60-300W transparent		20	12,36 €
		Regulation with rotary control. Not wired. Power range 60-300W	100	11,77 €

Regulation with rotary control. Not wired. Power range 60-300W



Length (mm): 150 Width (mm): 45 High (mm): 29
 Colour: Transparent Voltage In (Vac): 230
 Frequency (Hz): 50~60 Power (W): 60~300
 Ingress Protection: IP20



ELECTRICAL EQUIPMENT > Electronic Devices > Regulators

Subfamily **Hand Dimmers Ardit**

Picture	Article	Description	Lot	Price/Unit
 	A472420		1	15,94 €
	Dimmer 101S -RL 7242 black 40-160W		5	12,26 €
	Sensorial regulation. No cable		20	11,48 €
			100	10,92 €
	Length (mm): 89 Width (mm): 40 High (mm): 27 Colour: Black Voltage In (Vac): 230 Frecuency (Hz): 50 Power (W): 40~160 Ingress Protection: IP20			
				

 	SK04003		1	17,23 €
	Dimmer 1002 black		10	15,78 €
	Dimming by continuous push pressure, ON-OFF with quick press. With memory		50	15,00 €
	Length (mm): 70 Width (mm): 28,8 High (mm): 18,1 Colour: Black Voltage In (Vac): 230 Frecuency (Hz): 50~60 Power (W): 10~150 Ingress Protection: IP20 Dimmable: Corte fin de fase (IGBT)			
	Reference: 027503			
				

ELECTRICAL EQUIPMENT > Electronic Devices > Regulators

Subfamily **Hand Dimmers Arditì**

Picture	Article	Description	Lot	Price/Unit
	SK04004		1	17,23 €
	Dimmer 1002 white		10	15,78 €
			50	15,00 €
	Dimming by continuous push pressure, ON-OFF with quick press. With memory			
	Length (mm): 70 Width (mm): 28,8 High (mm): 18,1 Colour: White Voltage In (Vac): 230 Frecuency (Hz): 50~60 Power (W): 10~150 Ingress Protection: IP20 Dimmable: Corte fin de fase (IGBT) Reference: 027504			



	SK04005		1	17,23 €
	Dimmer 1002 transparent		10	15,78 €
			50	15,00 €
	Dimming by continuous push pressure, ON-OFF with quick press. With memory			
	Length (mm): 70 Width (mm): 29 High (mm): 18 Colour: Transparent Voltage In (Vac): 230 Frecuency (Hz): 50~60 Power (W): 10~150 Room Temperature (°C): +35 Ingress Protection: IP20 Dimmable: Corte fin de fase (IGBT) Reference: 027505			



Catalogue **ELECTRICAL EQUIPMENT**

Line **Electronic Devices**

FAMILY **Regulators**

Subfamily **Floor Dimmers Arditi**

Picture	Article	Description	Lot	Price/Unit
	A414790		1	7,87 €
	Dimmer PUNTO RQ 1479/110 Black		20	6,84 €
	Attention ! . For Input Voltage 110Volts		100	6,51 €
	Voltage In (Vac): 110 Frecuency (Hz): 50~60 Power (W): 500			



	A473170		1	52,66 €
	Dimmer with transformer 5500 RL 7317 black 20-60W		5	40,51 €
	For lamp 12V No cable		20	38,27 €
	Length (mm): 109 Width (mm): 61 High (mm): 33 Colour: Black Voltage In (Vac): 230 Voltage Out (Vdc): 12 Frecuency (Hz): 50~60 Power (W): 20~60 Room Temperature (°C): -15~+35 Ingress Protection: IP20		100	37,09 €



ELECTRICAL EQUIPMENT > Electronic Devices > Regulators

Subfamily **Floor Dimmers Arditì**

Picture	Article	Description	Lot	Price/Unit
	AR5510105		1	9,00 €
	Dimmer AD-1001 green		25	8,35 €
	Foot dimmer with cursor, Led of positioning. Power 60 to 300W		100	8,09 €
		Length (mm): 130 Width (mm): 65 High (mm): 25 Colour: Green Voltage In (Vac): 230 Frecuency (Hz): 50 Power (W): 60~300		

[Image in another color](#)



	AR5510106		1	9,00 €
	Dimmer AD-1001 blue		25	8,35 €
	Foot dimmer with cursor, Led of positioning. Power 60 to 300W		100	8,09 €
		Length (mm): 130 Width (mm): 65 High (mm): 25 Colour: Blue Voltage In (Vac): 230 Frecuency (Hz): 50 Power (W): 60~300		

[Image in another color](#)



ELECTRICAL EQUIPMENT > Electronic Devices > Regulators

Subfamily **Floor Dimmers Ardit**

Picture	Article	Description	Lot	Price/Unit
	AR5510107		1	9,00 €
	Dimmer AD-1001 red		25	8,35 €
	Foot dimmer with cursor, Led of positioning. Power 60 to 300W		100	8,09 €
		Length (mm): 130 Width (mm): 65 High (mm): 25 Colour: Red Voltage In (Vac): 230 Frecuency (Hz): 50 Power (W): 60~300		

[Image in another color](#)



	AR5510109		1	9,00 €
	Dimmer AD-1001 orange		25	8,35 €
	Foot dimmer with cursor, Led of positioning. Power 60 to 300W		100	8,09 €

[Image in another color](#)



ELECTRICAL EQUIPMENT > Electronic Devices > Regulators

Subfamily **Floor Dimmers Arditì**

Picture	Article	Description	Lot	Price/Unit
	AR55112AS3		1	28,44 €
	Light regulator for incandescence 1012AS		5	17,78 €
	Transparent 60-300W		10	16,16 €
	Regulatory standing with cursor and switch		40	15,44 €
	High (mm): 29 Diameter (mm): 100,25 Colour: Transparent Voltage In (Vac): 220~240 Frecuency (Hz): 50~60 Power (W): 60~300 Room Temperature (°C): +35 Reference: 034100			



	AR55112S1		1	28,39 €
	1012S Black Dimmer		5	17,76 €
	Regulatory standing with cursor and switch		10	16,16 €
	Regulatory standing with cursor and switch		40	15,46 €
	High (mm): 36,6 Diameter (mm): 100,25 Colour: Black Voltage In (Vac): 230 Frecuency (Hz): 50~60 Power (W): 60~300 Ingress Protection: IP20 Dimmable: Corte inicio de Fase (triac) Reference: 034098			



ELECTRICAL EQUIPMENT > Electronic Devices > Regulators

Subfamily **Floor Dimmers Ardit**

Picture	Article	Description	Lot	Price/Unit
	AR5540125		1	12,56 €
	Dimmer AD1011 cabled 150-250cm green		25	11,62 €
	Foot dimmer with cursor. Power 60 to 300W, 150cm cable to plug and 250cm to free end		100	11,28 €
	Length (mm): 130 Width (mm): 65 High (mm): 25 Colour: Green Voltage In (Vac): 230 Frecuency (Hz): 50 Power (W): 60~300			

Image in another color



	AR5540126		1	12,56 €
	Dimmer AD1011 cabled 150-250cm blue		25	11,62 €
	Foot dimmer with cursor. Power 60 to 300W, 150cm cable to plug and 250cm to free end		100	11,28 €
	Length (mm): 130 Width (mm): 65 High (mm): 25 Colour: Blue Voltage In (Vac): 230 Frecuency (Hz): 50 Power (W): 60~300			

Image in another color



ELECTRICAL EQUIPMENT > Electronic Devices > Regulators

Subfamily **Floor Dimmers Arditì**



Picture	Article	Description	Lot	Price/Unit
	AR5540129		1	12,56 €
	Dimmer AD1011 cabled 150-250cm orange		25	11,62 €
	Foot dimmer with cursor. Power 60 to 300W, 150cm cable to plug and 250cm to free end		100	11,28 €
		Length (mm): 130 Width (mm): 65 High (mm): 25 Colour: Orange Voltage In (Vac): 230 Frecuency (Hz): 50 Power (W): 60~300		

Image in another color



	AR55113S1		1	22,17 €
	Dimmer 1013S black		5	13,85 €
	Regulatory standing with cursor positioning switch and LED. For incandescent lamps.		10	12,48 €
		Length (mm): 130 Width (mm): 68 High (mm): 34,5 Colour: Black Voltage In (Vac): 230 Frecuency (Hz): 50 Power (W): 60~300 Ingress Protection: IP20 Dimmable: Corte inicio de Fase (triac)	50	11,93 €
		Reference: 034116		



Catalogue **ELECTRICAL EQUIPMENT**

Line **Electronic Devices**

FAMILY **Lighting Sensors**

Subfamily **Relays Relco**

Picture	Article	Description	Lot	Price/Unit
	G508120IR3		1	7,64 €
	Electronic Relay AEK120-IR-3 sensor IR and dimmer		5	6,37 €
	CCT 12/24Vdc		10	5,85 €
	With IR sensor included 1m wiring with connector. diameter 15mm. Detection 3-8 cm.		100	5,59 €
	Length (mm): 108 Width (mm): 44 High (mm): 15 Colour: White Voltage In (Vdc): 12~24 Voltage Out (Vdc): 12~24 Intensidad In (A): 5 Intensidad Out (A): 5 Power (W): 60~120 Room Temperature (°C): +35 Critical Temperature (°C): 80 Life (Hours): 50000 Ingress Protection: IP20			

LETARON



Subfamily **Relays Relco**



Picture	Article	Description	Lot	Price/Unit
	G508200IR		1	10,92 €
	Electronic Relay AEK200-IR sensor IR 120-240Vac		5	9,10 €
	Includes wired sensor and connector. Diameter 15mm. 3-8 cm detection by passing the hand ON / OFF function. 5 year warranty		10	8,32 €
	Length (mm): 108 Width (mm): 44 High (mm): 15 Colour: White Voltage In (Vac): 120~240 Voltage Out (Vac): 120~240 Intensidad In (A): 1 Intensidad Out (A): 1 Frecuency (Hz): 50~60 Power (W): 120~240 Room Temperature (°C): +40 Critical Temperature (°C): 80 Life (Hours): 50000 Ingress Protection: IP20		100	7,93 €





	G508SL01A		1	9,76 €
	Brightness sensor for dimmable Led drivers 0 / 1-10V		5	8,14 €
	It detects the brightness of the environment and regulates the intensity of the luminaire automatically. Adjustable sensitivity 10-500lux .. Wide detection area.		10	7,42 €
	High (mm): 24 Diameter (mm): 23 Colour: White Voltage Out (Vdc): 1~10 Intensidad Out (A): 0.05 Room Temperature (°C): -20~+50 Angle (°): 90 Ingress Protection: IP20		50	7,03 €









Subfamily **Relays Relco**

Picture	Article	Description	Lot	Price/Unit
	G507IR0		1	22,19 €
		Electronic relay SHE-B-250 with PIR motion sensor	5	20,16 €
			10	18,34 €
		With 1.5 meters of cable, 80° and time of 10 seconds. 3 min. 250W. Maximum distance 2.5 meters. class II	100	17,15 €
		Length (mm): 83 Width (mm): 35 High (mm): 21 Voltage In (Vac): 100~240 Intensidad Out (A): 1 Frecuency (Hz): 50~60 Maximum Power (W): 250 Temperature (°C): 80 Room Temperature (°C): -20~+50 Critical Temperature (°C): 70 Ingress Protection: IP20		
 				

	G507IRB		1	20,41 €
		Electronic Relay HZK218B with infrared sensor IR cabinets	5	18,56 €
			10	16,87 €
		Recommended detection range less than 5cm. with 2m of cable and sensor, for cabinets to open ON and close OFF. Sensor insertion hole diameter 13mm.	100	15,77 €
		Length (mm): 83 Width (mm): 35 High (mm): 19 Voltage In (Vac): 110~240 Frecuency (Hz): 50~60 Power (W): 250 Temperature (°C): 80		
 				

Subfamily **Relays Relco**

Picture	Article	Description	Lot	Price/Unit
	G5071RC		1	20,41 €
	Electronic Relay HZK218C with infrared IR hand sensor		5	18,56 €
			10	16,87 €
			100	15,77 €
	Recommended detection range less than 5cm. with 2m cable and sensor. Sensor insert hole diameter 13mm. Swipe to turn it on and off. Length (mm): 83 Width (mm): 35 High (mm): 19 Voltage In (Vac): 230 Frecuency (Hz): 50~60 Power (W): 250 Temperature (°C): 80			
 				

	G507201		1	15,77 €
	Electronic relay HZK201 with touch sensor		5	14,34 €
			10	13,04 €
			100	12,18 €
	Adjustable touch sensitivity. Maximum 4 meters touch control cable. Length (mm): 106 Width (mm): 32 High (mm): 21 Voltage In (Vac): 220~240 Voltage Out (Vac): 220~240 Frecuency (Hz): 50 Power (W): 500 Temperature (°C): 80 Ingress Protection: IP20			
 				

Catalogue **ELECTRICAL EQUIPMENT**
 Line **Electronic Devices**
 FAmily **Electronic Transformers Relco**
 Subfamily **Independent Electronic Transformers Relco**

Picture	Article	Description	Lot	Price/Unit
	K-KTC-60LA-CORD		1	3,80 €
	Electronic Transformer 12V -20-60W cableado 2 m		10	3,61 €
			20	3,51 €
	Length (mm): 140 Width (mm): 41 High (mm): 18,5 Colour: Black Voltage In (Vac): 240 Voltage Out (Vdc): 11.4 Frecuency (Hz): 50~60 Room Temperature (°C): +50 Critical Temperature (°C): 75			

	A416080		1	17,33 €
	Electronic transformer MICRO 60PFS-RN1608		5	13,34 €
			25	12,79 €
	Connection on the same side IN (2) OUT (2). Power range 10-60W		75	12,29 €
	Length (mm): 103 Width (mm): 31 High (mm): 21 Colour: White Voltage In (Vac): 230~240 Voltage Out (Vdc): 12 Frecuency (Hz): 50~60 Power (W): 10~60 Room Temperature (°C): -15~+40 Critical Temperature (°C): 80 Ingress Protection: IP20 Power factor: 0.98			



Subfamily **Independent Electronic Transformers Relco**



Picture	Article	Description	Lot	Price/Unit
	A416040		1	23,89 €
	Electronic transformer ICE 105PFS TH-RN1604		5	18,38 €
	Dimmable. Connection opposite side IN(4)		25	17,51 €
	OUT(6).Power range 20-105W		75	17,00 €
	Length (mm): 145 Width (mm): 39 High (mm): 28 Colour: White Voltage In (Vac): 230~240 Voltage Out (Vdc): 12 Frecuency (Hz): 50~60 Power (W): 20~105 Room Temperature (°C): -15~+53 Critical Temperature (°C): 87 Ingress Protection: IP20 Power factor: 0.98			





	A416120		1	17,89 €
	Electronic transformer ELEPH 70PFS-RN1612		50	16,26 €
	Connection opposite side IN(4) OUT(8). With female AMP connector		100	15,48 €
	Length (mm): 127 Width (mm): 31 High (mm): 21 Colour: White Voltage In (Vac): 230 Voltage Out (Vdc): 12 Frecuency (Hz): 50~60 Power (W): 20~70 Room Temperature (°C): +35 Critical Temperature (°C): 85 Ingress Protection: IP20			



Subfamily **Independent Electronic Transformers Relco**

Picture	Article	Description	Lot	Price/Unit
	A416310		1	22,28 €
	Electronic transformer ELEPH 105PFS-RN1610		20	20,25 €
	Connection opposite side IN(4) OUT(12). With female AMP connector		60	19,29 €
		Length (mm): 150 Width (mm): 55 High (mm): 19 Colour: White Voltage In (Vac): 230 Voltage Out (Vdc): 12 Frecuency (Hz): 50~60 Power (W): 20~105 Room Temperature (°C): -20~+35 Critical Temperature (°C): 75 Ingress Protection: IP20		
				

	A415810		1	21,24 €
	Electronic transformer FOX 105PF TH PLUS RN1581		50	19,31 €
	Dimmable. Connection same side IN(2) OUT(2)		100	18,38 €
		Length (mm): 123 Width (mm): 38 High (mm): 28 Colour: White Voltage In (Vac): 230~240 Voltage Out (Vdc): 12 Frecuency (Hz): 50~60 Power (W): 20~105 Room Temperature (°C): -15~+40 Critical Temperature (°C): 100 Ingress Protection: IP20		
				

Subfamily **Independent Electronic Transformers Relco**









Picture	Article	Description	Lot	Price/Unit
	A415990		1	16,15 €
	Electronic transformer FOX 80PF-RN 1599		25	14,68 €
	Dimmable. Connection same side IN(2) OUT(2)		75	13,96 €
	Length (mm): 123 Width (mm): 38 High (mm): 28 Colour: White Voltage In (Vac): 230~240 Voltage Out (Vdc): 12 Frecuency (Hz): 50~60 Power (W): 20~80 Room Temperature (°C): -15~+45 Critical Temperature (°C): 85 Ingress Protection: IP20			



	A416000		1	23,10 €
	Electronic transformer FOX S 105PFS TH -RN1600		5	17,76 €
	Dimmable.Adjustable.Connection on the same side IN (2) OUT (2). Power range 10-105W		75	16,43 €
	Length (mm): 123 Width (mm): 38 High (mm): 28 Colour: White Voltage In (Vac): 230~240 Voltage Out (Vdc): 12 Frecuency (Hz): 50~60 Power (W): 20~105 Room Temperature (°C): -15~+40 Critical Temperature (°C): 100 Ingress Protection: IP20			



Subfamily **Independent Electronic Transformers Relco**

Picture	Article	Description	Lot	Price/Unit
	A416640	Electronic transformer MINI BRAVO RN1100		
		<p>Dimmable with potentiometer included. Connection opposite side IN(2) OUT(2). Power 20-70W</p> <p>High (mm): 21 Diameter (mm): 72 Colour: White Voltage In (Vac): 230~240 Frecuency (Hz): 50~60 Power (W): 20~70 Room Temperature (°C): -15~+45 Critical Temperature (°C): 75 Ingress Protection: IP20</p>		
		      		

	GTV012070		1	21,07 €
		Dimmable electronic transformer MW 70 12V 70W	5	19,16 €
		Dimmable electronic transformer by end-of-phase cutting for 12Vac halogen and LED lamps	10	17,42 €
			50	16,13 €
		<p>Length (mm): 117 Width (mm): 32 High (mm): 20 Colour: White Voltage In (Vac): 230~240 Voltage Out (Vac): 12 Frecuency (Hz): 50~60 Power (W): 2.5~70 Room Temperature (°C): -25~+40 Critical Temperature (°C): 90 Ingress Protection: IP20 Dimmable: Corte fin de fase (IGBT) Power factor: 0.98</p> <p>Reference: 119772</p>		

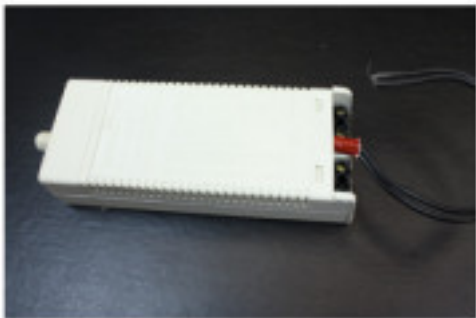

Catalogue **ELECTRICAL EQUIPMENT**
 Line **Electronic Devices**
 Family **Electronic Transformers Relco**
 Subfamily **To built-in Electronic Transformers Relco**

Picture	Article	Description	Lot	Price/Unit
	A413180		1	14,91 €
	Electronic transformer ETV 75PF-RN1318		25	14,20 €
		Voltage In (Vac): 230 Voltage Out (Vdc): 12 Frecuency (Hz): 50 Power (W): 75 Ingress Protection: IP20	75	13,78 €



	A416641		1	29,24 €
	Electronic transformer HOLE 70PFS-RN1664		5	22,49 €
		Dimmable. Connection opposite side IN(2) OUT(2). Power 20-70W	25	21,42 €
			75	20,80 €

High (mm): 22 Diameter (mm): 53 Colour: White
 Voltage In (Vac): 230~240 Voltage Out (Vdc): 12
 Frecuency (Hz): 50~60 Power (W): 20~70
 Room Temperature (°C): -15~+40
 Critical Temperature (°C): 85 Ingress Protection: IP20



ELECTRICAL EQUIPMENT > Electronic Devices > Electronic Transformers Relco

Subfamily **To built-in Electronic Transformers Relco**

Picture	Article	Description	Lot	Price/Unit
	A416720		1	27,30 €
	Electronic transformer HOLE 105PFS-RN1672		5	21,00 €
	Dimmable. Connection opposite side IN(2) OUT(2)		25	20,05 €
	Power 35-105W		75	19,40 €
	High (mm): 22 Diameter (mm): 70 Colour: White Voltage In (Vac): 230 Voltage Out (Vdc): 12 Frecuency (Hz): 50~60 Power (W): 35~105 Room Temperature (°C): -15~+40 Critical Temperature (°C): 88 Ingress Protection: IP20			



Catalogue **ELECTRICAL EQUIPMENT**

Line **Electronic Devices**

FAMILY **Electronic Transformers Relco**

Subfamily **Transformers Extra-flat Relco IP45**

Picture	Article	Description	Lot	Price/Unit
	A411280		1	17,51 €
	Electronic transformer STILO 105PFS IP45 RN1128		20	15,98 €
	Extra-flat. IP45. Dimmable. Connection opposite side IN (2) OUT (4)		60	15,22 €
	Length (mm): 140 Width (mm): 54 High (mm): 16 Colour: White Voltage In (Vac): 230 Voltage Out (Vdc): 12 Frecuency (Hz): 50~60 Power (W): 105 Room Temperature (°C): -20~+40 Critical Temperature (°C): 75 Ingress Protection: IP45			



Catalogue **ELECTRICAL EQUIPMENT**
 Line **Electronic Devices**
 Family **Electronic Transformers Relco**
 Subfamily **Plug-in Electronic Transformers Relco**

Picture	Article	Description	Lot	Price/Unit
	A413150		1	54,65 €
	Plug-in electronic transformer 600N RN1315 20-50W black		5	42,04 €
			10	39,39 €
	With 2m cable with transformer connector. Voltage 230 / 12V. Power range 20-50W		20	37,64 €
	Length (mm): 78 Width (mm): 45 High (mm): 35 Colour: Black Voltage In (Vac): 230 Voltage Out (Vdc): 12 Frecuency (Hz): 50~60 Power (W): 50 Room Temperature (°C): -15~+35 Critical Temperature (°C): 60 Ingress Protection: IP20			



	A45766B		1	25,04 €
	DOPPEL B - RQ 5766/B		10	23,86 €
			20	23,17 €
	Electronic card for 2 light sources. Power range for 12V On-Off 35-50W and regulation for 230V 75-300W.			
	Length (mm): 149 Width (mm): 140 High (mm): 31 Voltage In (Vac): 230 Frecuency (Hz): 50~60			





Catalogue **ELECTRICAL EQUIPMENT**

Line **Electronic Devices**

FAMILY **Toroidal Transformers**



Subfamily **Toroidal Transformers**



Picture	Article	Description	Lot	Price/Unit
	A419380		1	13,79 €
	Toroidal transformer 50 F RN1938		10	13,13 €
	Dimmable		20	12,75 €
	Voltage In (Vac): 230~240 Voltage Out (Vdc): 11.5 Frecuency (Hz): 50~60 Power (W): 50 Room Temperature (°C): -15~+50 Ingress Protection: IP20			
				

	A427600		1	0,4778 €
	Nylon ring for toroidal transformer		50	0,4384 €
	High (mm): 6,5 Diameter (mm): 80 Colour: Black		100	0,3515 €
				

ELECTRICAL EQUIPMENT > Electronic Devices > Toroidal Transformers

Subfamily **Toroidal Transformers**

Picture	Article	Description	Lot	Price/Unit
	A427940		1	0,3530 €
	Rubber disc for toroidal transformer		50	0,3238 €
	Diameter (mm): 60 Colour: Black		100	0,2569 €
				

	A428020		1	0,4073 €
	Rubber disc for toroidal transformer		50	0,3736 €
	Diameter (mm): 80 Colour: Black		100	0,2704 €
				

Catalogue **ELECTRICAL EQUIPMENT**

Line **Electronic Devices**

FAMILY **Magnetic Transformers**

Subfamily **Magnetic Transformers**

Picture	Article	Description	Lot	Price/Unit
	A387371		1	14,89 €
	Transformer STG/12 TS 105W Class II		10	14,18 €
		Length (mm): 272 Width (mm): 46 High (mm): 41 Colour: White Voltage In (Vac): 230 Voltage Out (Vdc): 11.5 Frecuency (Hz): 50~60 Power (W): 105 Room Temperature (°C): +25 Critical Temperature (°C): 80 Ingress Protection: IP20	50	13,78 €

	A387657		1	17,37 €
	Ferromagnetic transformer KTR 105W		10	15,50 €
		Length (mm): 240 Width (mm): 41,5 High (mm): 28,6 Colour: White Voltage In (Vac): 230 Voltage Out (Vdc): 11.5 Frecuency (Hz): 50~60 Power (W): 105 Room Temperature (°C): +40 Ingress Protection: IP20	100	12,94 €

TRIDONIC



Catalogue **ELECTRICAL EQUIPMENT**

Line **Electronic Devices**

FAMILY **Electronic Ballast Relco**

Subfamily **Electronic ballast mod. EB-FH (1X)**

Picture	Article	Description	Lot	Price/Unit
	A424720		1	13,65 €
	Electronic Ballast EB21FHG5 RN2472		10	11,87 €
	For lamp : 1xT5 21W		30	11,30 €

Length (mm): 177 Width (mm): 22,4 High (mm): 20
 Colour: White Voltage In (Vac): 230
 Frecuency (Hz): 50~60
 Room Temperature (°C): 0~+40
 Critical Temperature (°C): 75 Ingress Protection: IP20







Catalogue **ELECTRICAL EQUIPMENT**

Line **Electronic Devices**







FAMILY **Electronic Ballast Relco**

Subfamily **Electronic ballast mod. EB-G5 (1X)**

Picture	Article	Description	Lot	Price/Unit
	A421070		1	33,16 €
	Electronic Ballast EB54G5 RN2107		20	28,83 €
	For lamp 1xT5 54W		60	27,46 €
	Length (mm): 235 Width (mm): 30 High (mm): 28 Colour: White Voltage In (Vac): 230 Frecuency (Hz): 50~60 Room Temperature (°C): -15~+55 Critical Temperature (°C): 70 Ingress Protection: IP20			
		    		
	A422460		1	24,86 €
	Electronic Ballast EB14G5 RN2246		20	22,79 €
	For lamp 1xT5 14W		60	21,76 €
	Length (mm): 278 Width (mm): 30 High (mm): 21 Colour: White Voltage In (Vac): 110~240 Frecuency (Hz): 50~60 Room Temperature (°C): -15~+55 Critical Temperature (°C): 70 Ingress Protection: IP20			
		   		

ELECTRICAL EQUIPMENT > Electronic Devices > Electronic Ballast Relco

Subfamily **Electronic ballast mod. EB-G5 (1X)**

Picture	Article	Description	Lot	Price/Unit
	A422500		1	30,16 €
	Electronic Ballast EB24G5 RN2250		20	26,23 €
		For lamps 1xT5 24W . Length (mm): 278 Width (mm): 30 High (mm): 21 Colour: White Voltage In (Vac): 110~240 Frecuency (Hz): 50~60 Room Temperature (°C): -15~+55 Critical Temperature (°C): 70		
		    		





	A422510		1	27,05 €
	Electronic Ballast EB39G5 RN2251		20	24,82 €
		For lamp 1xT5 39W	60	23,66 €
		Length (mm): 278 Width (mm): 30 High (mm): 21 Colour: White Voltage In (Vac): 230 Frecuency (Hz): 50~60 Room Temperature (°C): -15~+55 Critical Temperature (°C): 70 Ingress Protection: IP20		
		    		

Catalogue **ELECTRICAL EQUIPMENT**

Line **Electronic Devices**

FAMILY **Electronic Ballast Relco**







Subfamily **Electronic ballast mod. EB-G5 (2X)**

Picture	Article	Description	Lot	Price/Unit
	A421090		1	36,49 €
	Electronic Ballast EB221G5 RN2109		20	31,73 €
	For lamps 2xT5 21W		60	30,21 €
	Length (mm): 278 Width (mm): 30 High (mm): 21 Colour: White Voltage In (Vac): 230 Frecuency (Hz): 50~60 Room Temperature (°C): -15~+55 Critical Temperature (°C): 70 Ingress Protection: IP20			
	A421110		1	38,44 €
	Electronic Ballast EB235G5 RN2111		20	33,42 €
	For lamps 2xT5 35W		60	31,82 €
	Length (mm): 360 Width (mm): 30 High (mm): 29 Colour: White Voltage In (Vac): 230 Frecuency (Hz): 50~60 Room Temperature (°C): -15~+55 Critical Temperature (°C): 70 Ingress Protection: IP20			

ELECTRICAL EQUIPMENT > Electronic Devices > Electronic Ballast Relco

Subfamily **Electronic ballast mod. EB-G5 (2X)**

Picture	Article	Description	Lot	Price/Unit
	A421130		1	40,78 €
	Electronic Ballast EB254G5 RN2113		20	35,45 €
	For lamps 2xT5 54W		60	33,77 €
	Length (mm): 360 Width (mm): 30 High (mm): 29 Colour: White Voltage In (Vac): 230 Frecuency (Hz): 50~60 Room Temperature (°C): -15~+55 Critical Temperature (°C): 70			
	    			











	A422530		1	28,20 €
	Electronic Ballast EB224G5 RN2253		20	25,88 €
	For lamps 2xT5 24W		60	24,61 €
	Length (mm): 278 Width (mm): 30 High (mm): 21 Colour: White Voltage In (Vac): 230 Frecuency (Hz): 50~60 Room Temperature (°C): -20~+50 Critical Temperature (°C): 65 Ingress Protection: IP20			
	    			

Catalogue **ELECTRICAL EQUIPMENT**

Line **Electronic Devices**

FAMILY **Electronic Ballast Relco**

Subfamily **Electronic ballast mod. EBS (1X)**

Picture	Article	Description	Lot	Price/Unit
	A424040		1	13,31 €
	Electronic Ballast EBS18 RN2404		20	12,10 €
		For lamps : 1xTC-T/E 18W ; 1xTC-D/E 18W	60	11,49 €
		Length (mm): 103 Width (mm): 67 High (mm): 24 Colour: White Voltage In (Vac): 230 Frecuency (Hz): 50~60 Room Temperature (°C): -10~+55 Critical Temperature (°C): 75 Ingress Protection: IP20		
		    		
	A424120		1	23,87 €
	Electronic Ballast EBS42 RN2412		20	21,89 €
		Colour: White Voltage In (Vac): 230 Frecuency (Hz): 50~60 Room Temperature (°C): -10~+55		
				

ELECTRICAL EQUIPMENT > Electronic Devices > Electronic Ballast Relco

Subfamily **Electronic ballast mod. EBS (1X)**

Picture	Article	Description	Lot	Price/Unit
	A424140		1	29,74 €
	Electronic Ballast EBS55 RN2414		20	25,87 €
	For lamps : 1xTC-L 55W ; 1xTC-T5C 55W		60	24,64 €
	Length (mm): 123 Width (mm): 78 High (mm): 31 Colour: White Voltage In (Vac): 230 Frecuency (Hz): 50~60 Room Temperature (°C): -10~+55 Critical Temperature (°C): 80 Ingress Protection: IP20			



Catalogue **ELECTRICAL EQUIPMENT**

Line **Electronic Devices**

FAMILY **Electronic Ballast Relco**

Subfamily **Electronic ballast mod. EB-G13 (2X)**

Picture	Article	Description	Lot	Price/Unit
	A420960		1	37,87 €
	Electronic Ballast EB218G13 RN2096		20	32,93 €
	Lamps : 2xT818W ; 2xTC-L18W ; 2xTC-F18W ; 2xPL-L18W		60	31,37 €
		Length (mm): 365 Width (mm): 30 High (mm): 30 Colour: White Voltage In (Vac): 230 Frecuency (Hz): 50~60 Room Temperature (°C): -25~+50 Critical Temperature (°C): 65 Ingress Protection: IP20		
		      		

Catalogue **ELECTRICAL EQUIPMENT**
 Line **Electronic Devices**
 FAmily **Electronic Ballast Tridonic**
 Subfamily **Electronic ballast mod PCA ECO (1X)**

Picture	Article	Description	Lot	Price/Unit
	A2PDE180		1	45,10 €
	Electronic ballast PCA 1/80 TCL ECO		10	39,21 €
	Dimmable. lamp 1xTC-L 80W		50	37,34 €
	Length (mm): 360 Width (mm): 30 High (mm): 28 Colour: White Voltage In (Vac): 230 Frecuency (Hz): 0~60 Room Temperature (°C): -25~+50 Critical Temperature (°C): 70			

TRIDONIC



	A2PRE118		1	45,10 €
	Electronic ballast PCA 1/18 TCD ECO		10	39,21 €
	Dimmable. Lamps TC-DEL 1x18W ; TC-TEL 1x18W		50	37,34 €
	Length (mm): 123 Width (mm): 79 High (mm): 31 Colour: White Voltage In (Vac): 230 Frecuency (Hz): 0~60 Room Temperature (°C): -25~+60 Critical Temperature (°C): 75			

TRIDONIC



ELECTRICAL EQUIPMENT > Electronic Devices > Electronic Ballast Tridonic

Subfamily **Electronic ballast mod PCA ECO (1X)**

Picture	Article	Description	Lot	Price/Unit
	A2T5128		1	48,20 €
	Electronic ballast PCA 1x28 T5 ECO Ip		10	41,91 €
	Lamp : 1xT5 FQ 28W		50	39,91 €
	Length (mm): 360 Width (mm): 30 High (mm): 21 Colour: White Voltage In (Vac): 230 Frecuency (Hz): 0~60 Room Temperature (°C): -25~+60 Critical Temperature (°C): 80			

TRIDONIC



Catalogue **ELECTRICAL EQUIPMENT**
 Line **Electronic Devices**
 FAmily **Electronic Ballast Tridonic**
 Subfamily **Electronic ballast mod PCA ECO (2X)**

Picture	Article	Description	Lot	Price/Unit
	A2PRE218		1	50,91 €
	Electronic ballast PCA 2/18 TCD ECO		10	44,27 €
	Dimmable. lamps TC-DEL 2x18W ; TC-TEL 2x18W		50	42,17 €
	Length (mm): 123 Width (mm): 102 High (mm): 31 Colour: White Voltage In (Vac): 230 Frecuency (Hz): 0~60 Room Temperature (°C): -25~+60 Critical Temperature (°C): 85 Ingress Protection: IP20			

TRIDONIC



Catalogue **ELECTRICAL EQUIPMENT**
 Line **Electronic Devices**
 FAmily **Electronic Ballast Tridonic**
 Subfamily **Electronic ballast Modelo PC PRO (2X)**

Picture	Article	Description	Lot	Price/Unit
	A2PR218		1	19,16 €
	Electronic ballast PC 2x18W TCD PRO		10	16,67 €
	Lamps : 2xTC-D/E 18W ; 2xTC-T/E 18W		50	15,87 €

Length (mm): 103 Width (mm): 67 High (mm): 31
 Colour: White Voltage In (Vac): 230
 Frecuency (Hz): 0~60
 Room Temperature (°C): -25~+50
 Critical Temperature (°C): 70 Ingress Protection: IP20

TRIDONIC



Catalogue **ELECTRICAL EQUIPMENT**

Line **Electronic Devices**

FAMILY **Electronic Ballast Self**

Subfamily **Electronic Ballast SBE-G24**

Picture	Article	Description	Lot	Price/Unit
	G501226		1	12,13 €
	Electronic ballast SBE 2X26-32		50	10,83 €
	Lamps : 2xTC-D/E 26W, 2xTC-T/E 26,32W		100	10,53 €

Length (mm): 120 Width (mm): 76 High (mm): 32
 Colour: White Voltage In (Vac): 230
 Frecuency (Hz): 50~60 Power (W): 64
 Room Temperature (°C): +50
 Critical Temperature (°C): 70



Catalogue **ELECTRICAL EQUIPMENT**

Line **Electronic Devices**

FAMILY **Magnetic Ballast**

Subfamily **Magnetic Ballasts Tridonic**

Picture	Article	Description	Lot	Price/Unit
	A202013		1	4,19 €
	Ferromagnetic ballast 13W very low losses		5	3,74 €
	EEL=B1 lamps : 1x13W TC-D		100	3,26 €
	Length (mm): 84,5 Width (mm): 41 High (mm): 31 Colour: White Voltage In (Vac): 230 Frecuency (Hz): 50			

TRIDONIC



	A202018		1	3,68 €
	Ferromagnetic ballast 18W very low losses		5	3,28 €
	EEL=B1 lamp : 1x18W TC-D		100	2,85 €
	Length (mm): 84,5 Width (mm): 41 High (mm): 31 Colour: White Voltage In (Vac): 230 Frecuency (Hz): 50			

TRIDONIC



ELECTRICAL EQUIPMENT > Electronic Devices > Magnetic Ballast

Subfamily **Magnetic Ballasts Tridonic**

Picture	Article	Description	Lot	Price/Unit
	A207000		1	13,43 €
	Ferromagnetic ballast OMBIS 70 A 101k 230/50		10	12,00 €
	For high pressure sodium and metal halide lamps 1x70W TW =130° terminal connections 0.5mm ²		30	11,65 €
		Length (mm): 107 Width (mm): 65 High (mm): 45 Colour: White Voltage In (Vac): 230 Frecuency (Hz): 50		

TRIDONIC



Catalogue **ELECTRICAL EQUIPMENT**
Line **Electronic Devices**
FAMILY **Enclosures For Fluorescence Equipment**
Subfamily **Box for fluorescent equipment**

Picture	Article	Description	Lot	Price/Unit
---------	---------	-------------	-----	------------

Catalogue **ELECTRICAL EQUIPMENT**
 Line **Electronic Devices**
 FAmily **Equipment For Discharge Lamps Relco**
 Subfamily **Equipment For Discharge Lamps Relco**

Picture	Article	Description	Lot	Price/Unit
	A453568		1	91,61 €
	Electronic ballast ESM150 1x150W		5	87,02 €
		Length (mm): 180 Width (mm): 88 High (mm): 36 Colour: White Voltage In (Vac): 230 Frecuency (Hz): 50~60 Power (W): 150 Room Temperature (°C): -15~+50 Critical Temperature (°C): 85 Ingress Protection: IP20	10	83,82 €



Catalogue **ELECTRICAL EQUIPMENT**
 Line **Electronic Devices**
 FAmily **Equipment For Discharge Lamps Relco**
 Subfamily **Equipment For Discharge Lamps Tridonic**

Picture	Article	Description	Lot	Price/Unit
	A29C1352		1	49,67 €
	Electronic ballast TRIDONIC PCI 35/70 PRO C011		15	43,15 €
		Length (mm): 100 Width (mm): 75 High (mm): 29 Voltage In (V): 220~240 Frecuency (Hz): 50~60 Power (W): 35~70 Room Temperature (°C): -25~+60 Critical Temperature (°C): 80 Ingress Protection: IP20	50	41,11 €

TRIDONIC



	A2PCI70		1	122,94 €
	Electronic ballast TRIDONIC HQI 70W PCI0070 A001		10	106,91 €
		TRIDONIC CODE 86448183. Voltage In (Vac): 220~240 Frecuency (Hz): 50~60 Room Temperature (°C): -25~+50 Critical Temperature (°C): 80		



TRIDONIC



Catalogue **ELECTRICAL EQUIPMENT**
 Line **Electronic Devices**
 Family **Starters, Capacitors and supressors**
 Subfamily **Starters**

Picture	Article	Description	Lot	Price/Unit
	A453993		1	1,25 €
	Starter SC480-S53993		25	0,96 €
			100	0,66 €
	Starter quick and reliable with internal capacitor		500	0,5717 €
	High (mm): 35 Diameter (mm): 21 Colour: White Voltage In (Vac): 220~250 Power (W): 4~80 Room Temperature (°C): -25~+70 Ingress Protection: IP20			











Catalogue **ELECTRICAL EQUIPMENT**
 Line **Electronic Devices**
 FAmily **Starters, Capacitors and supressors**
 Subfamily **Capacitors**

Picture	Article	Description	Lot	Price/Unit
	A300002		1	3,24 €
	Capacitor 2µF		75	2,90 €
	Capacitor for fluoescent and discharge lamps with screw M8 (nut and washer)		150	2,73 €
		Length (mm): 56,5 Diameter (mm): 25 Colour: White Ingress Protection: IP20		
		 		



	A300004		1	3,56 €
	Capacitor 4 µF		75	3,20 €
	Capacitor for fluoescent and discharge lamps with screw M8 (nut and washer)		150	2,99 €
		Length (mm): 56,5 Diameter (mm): 25 Colour: White Ingress Protection: IP20		
		 		

Subfamily **Capacitors**

Picture	Article	Description	Lot	Price/Unit
	A300005		1	3,80 €
	Capacitor 4 µF		75	3,39 €
	Capacitor for fluoresent and discharge lamps with screw M8 (nut and washer)		150	3,19 €
		Length (mm): 69,5 Diameter (mm): 25 Colour: White Ingress Protection: IP20		
		 		
	A300009		1	4,69 €
	Capacitor 9 microF		75	4,19 €
	Capacitor for fluoresent and discharge lamps with screw M8 (nut and washer)		150	3,64 €
		Length (mm): 69,5 Diameter (mm): 30 Colour: White Ingress Protection: IP20		
		 		
	A300012		1	5,11 €
	Capacitor 12 microF		50	4,59 €
	Capacitor for fluoresent and discharge lamps with screw M8 (nut and washer)		150	4,24 €
		Length (mm): 69,5 Diameter (mm): 30 Colour: White Ingress Protection: IP20		
		 		

ELECTRICAL EQUIPMENT > Electronic Devices > Starters, Capacitors and supressors

Subfamily **Capacitors**

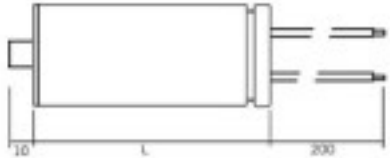
Picture	Article	Description	Lot	Price/Unit
	A300102		1	3,30 €
	Capacitor 3.5 microF		50	2,96 €
	Capacitor for fluoresent and discharge lamps with screw M8 (nut and washer)		150	2,80 €
	Length (mm): 56,5 Diameter (mm): 25 Colour: White Ingress Protection: IP20			
				
	A300103		1	3,37 €
	Capacitor 3.5 microF		50	3,03 €
	Capacitor for fluoresent and discharge lamps with screw M8 (nut and washer)		150	2,86 €
	Length (mm): 56,5 Diameter (mm): 25 Colour: White Ingress Protection: IP20			
		