



Catalogue **HALOTEC HARDWARE**
Line **Halotec Small Installation Material**
FAMILY **Multiple Plug and cable Reels**
Subfamily **Multiple Plug With Cable 3 Sockets**

Picture	Article	Description	Lot	Price/Unit
---------	---------	-------------	-----	------------

Catalogue **HALOTEC HARDWARE**
Line **Halotec Small Installation Material**
FAMILY **Multiple Plug and cable Reels**
Subfamily **Cable Reels**

Picture	Article	Description	Lot	Price/Unit
---------	---------	-------------	-----	------------

Catalogue **HALOTEC HARDWARE**
 Line **Halotec Small Installation Material**
 Family **Plugs and bases**
 Subfamily **Eur Plugs and Sockets**







Picture	Article	Description	Lot	Price/Unit
	CD80005		1	0,88 €
	White European Plug. 10A 250V		10	0,77 €
			100	0,70 €
	Length (mm): 65 Width (mm): 33 High (mm): 15 Colour: White Voltage In (Vac): 250 Intensidad In (A): 10 Ingress Protection: IP20		400	0,66 €



	CD80006		1	0,88 €
	Black European Plug. 10A 250V		10	0,77 €
			100	0,70 €
	Length (mm): 65 Width (mm): 33 High (mm): 15 Colour: White Voltage In (Vac): 250 Intensidad In (A): 10 Ingress Protection: IP20		400	0,66 €



Catalogue **HALOTEC HARDWARE**
 Line **Halotec Small Installation Material**
 Family **Plugs and bases**
 Subfamily **Schuko Plugs And Sockets**

Picture	Article	Description	Lot	Price/Unit
	SK08411A	Schuko mobile base. White 16A 250V	25 (Pedido mínimo)	1,89 €
	UNE20315	High (mm): 68 Diameter (mm): 48 Colour: White Voltage In (Vac): 250 Intensidad In (A): 16	50 100	1,73 € 1,64 €
		 		
	SK08419A	Schuko waterproof plug. 16A 250V	15 (Pedido mínimo)	3,71 €
	IEC 60884-1	High (mm): 114 Diameter (mm): 45 Colour: Black Voltage In (Vac): 250 Intensidad In (A): 16 Ingress Protection: IP44	30 90	3,34 € 3,20 €
		  		



HALOTEC HARDWARE > Halotec Small Installation Material > Plugs and bases

Subfamily **Schuko Plugs And Sockets**

Picture	Article	Description	Lot	Price/Unit
	SK08422		1	2,89 €
		Blister Base adjustable Waterproof Schuko. 16A 250V	12	2,41 €
	UNE20315		24	2,18 €
		Voltage In (Vac): 250 Intensidad In (A): 16		

HALOTEC®

Catalogue **HALOTEC HARDWARE**
 Line **Halotec Small Installation Material**
 Family **Adapters**
 Subfamily **Triple Socket Adapters**

Picture	Article	Description	Lot	Price/Unit
	SK08225		1	2,83 €
	Plug Adapter green 3 plugs earth terminal 10A/250V		24	2,57 €
	Child protection. Maximum 3500W		48	2,46 €
	Colour: Green Voltage In (Vac): 250 Intensidad In (A): 10~16			
				

	SK08227		1	2,83 €
	Plug Adapter orange 3 plugs earth terminal 10A/250V		24	2,57 €
	Child protection. Maximum 3500W		48	2,46 €
	Colour: Orange Voltage In (Vac): 250 Intensidad In (A): 10~16			
				

HALOTEC HARDWARE > Halotec Small Installation Material > Adapters

Subfamily Triple Socket Adapters

Picture	Article	Description	Lot	Price/Unit
	SK08229		1	2,70 €
		Plug Adapter blue 3 plugs earth terminal 10A/250V	24	2,46 €
		Family Safety. Maximo 3500W	48	2,34 €
		Colour: Blue Voltage In (Vac): 250 Intensidad In (A): 10-16		

HALOTEC®



Catalogue **HALOTEC HARDWARE**
Line **Halotec Small Installation Material**
FAMILY **Adapters**
Subfamily **Travel Adapter**

Picture	Article	Description	Lot	Price/Unit
---------	---------	-------------	-----	------------

Catalogue **HALOTEC HARDWARE**
 Line **Halotec Small Installation Material**
 Family **Adapters**
 Subfamily **USB Adapters**

Picture	Article	Description	Lot	Price/Unit
	SK08231		1	7,93 €
	Adapter 3 USB ports FILM + EAN		10	6,90 €
	OUTPUT: 5Vdc, 2.1A (total)		100	6,57 €
	Colour: White Voltage In (Vac): 100~230 Voltage Out (Vdc): 5 Intensidad In (A): 0.3 Intensidad Out (A): 2,1 Frecuency (Hz): 50~60			



Catalogue **HALOTEC HARDWARE**
 Line **Halotec Small Installation Material**
 FAmily **Plug Bases**
 Subfamily **Bases Surface Plug**

Picture	Article	Description	Lot	Price/Unit
	SK08302A		1	1,57 €
	Base de enchufe para canaleta		10	1,43 €
	Voltage In (Vac): 250 Intensidad In (A): 10~16		50	1,37 €
	CE			

	SK08322		1	0,98 €
	Plug base for channel FILM+EAN		12	0,88 €
	Voltage In (Vac): 250 Intensidad In (A): 10		48	0,85 €
	CE			

HALOTEC HARDWARE > Halotec Small Installation Material > Plug Bases

Subfamily **Bases Surface Plug**

Picture	Article	Description	Lot	Price/Unit
	SK08328		1	1,38 €
		Blister Round socket plug	20	1,20 €
		Voltage In (Vac): 250 Intensidad In (A): 10		



	SK08329		1	1,51 €
		Blister Plug base for channel	20	1,37 €
		Voltage In (Vac): 250 Intensidad In (A): 10	40	1,30 €



Catalogue **HALOTEC HARDWARE**
 Line **Halotec Small Installation Material**
 Family **Lampholders for Installing**
 Subfamily **Halotec Installation Thermoplastic Lampholders E27**

Picture	Article	Description	Lot	Price/Unit
	AR1412031		1	1,52 €
	Lampholder for instalation 912/CP102 black thermoplastic T210°		50	0,74 €
		Installation lampholder with cap. Connetion by screws for rigid or flexible 0,5-2,5mm2 cables		500
		High (mm): 67 Diameter (mm): 38,5 Colour: Black Voltage In (Vac): 250 Intensidad In (A): 4 Temperature (°C): 210 Connection: Screw Socket: E27		
		Reference: 029582		



	AR1412032		1	1,52 €
	Lampholder for instalation 912/CP102 white thermoplastic T210°		50	0,74 €
		Installation lampholder with cap. Connetion by screws for rigid or flexible 0,5-2,5mm2 cables		500
		High (mm): 67 Diameter (mm): 38,5 Colour: White Voltage In (Vac): 250 Intensidad In (A): 4 Temperature (°C): 210 Connection: Screw Socket: E27		
		Reference: 029957		



Catalogue **HALOTEC HARDWARE**
 Line **Halotec Small Installation Material**
 Family **Lampholders for Installing**
 Subfamily **Halotec thermoplastic Lampholders E27**

Picture	Article	Description	Lot	Price/Unit
	SK01001A		1	0,5910 €
	E27 black thermoplastic Lampholder mounted		250	0,5698 €



M10x1.Conexión fixing screw
 Colour: Black Voltage In (Vac): 250
 Intensidad In (A): 4 Temperature (°C): 190
 Reference: 039667



	SK01003A		1	0,61 €
	E27 White thermoplastic Lampholder mounted		250	0,5699 €



M10x1.Conexión fixing screw
 Colour: White Voltage In (Vac): 250
 Intensidad In (A): 4 Temperature (°C): 190
 Reference: 039666



Subfamily **Halotec thermoplastic Lampholders E27**

Picture	Article	Description	Lot	Price/Unit
	SK01009A		1	0,5968 €
		Half Threaded thermoplastic E27 lampholders black mounted no ring	250	0,5763 €
		M10x1.Conexión fixing screw		
		Colour: Black Voltage In (Vac): 250 Intensidad In (A): 4 Temperature (°C): 190 Reference: 040901		



	SK01011A		1	0,63 €
		Half Threaded thermoplastic E27 lampholders white mounted no ring	250	0,5929 €
		M10x1.Conexión fixing screw		
		Colour: White Voltage In (Vac): 250 Intensidad In (A): 4 Temperature (°C): 190 Reference: 040902		



Catalogue **HALOTEC HARDWARE**
 Line **Halotec Small Installation Material**
 Family **Lampholders for Installing**
 Subfamily **Halotec Light point thermoplastic lampholders E27**

Picture	Article	Description	Lot	Price/Unit
	SK01054A		1	7,58 €
	E27 copper straight socket lamp holder		10	5,07 €
			50	4,69 €
	Thermoplastic. Automatic connection for rigid or flexible cables from 0.5 to 2.5mm2.		200	4,47 €
	High (mm): 58,2 Diameter (mm): 83 Colour: Copper Voltage In (Vac): 250 Temperature (°C): 180 Connection: Automatic Socket: E27			
	Reference: 041761			



	SK01055A		1	7,59 €
	E27 chrome straight socket lamp holder		10	5,08 €
			50	4,71 €
	Thermoplastic. Automatic connection for rigid or flexible cables from 0.5 to 2.5mm2.		200	4,49 €
	Colour: Chrome Voltage In (Vac): 250 Temperature (°C): 180 Connection: Automatic Socket: E27			
	Reference: 041762			



Subfamily **Halotec Light point thermoplastic lampholders E27**

Picture	Article	Description	Lot	Price/Unit
	SK01056A		1	7,59 €
	E27 Golden straight socket lamp holder		10	5,08 €
			50	4,71 €
	Thermoplastic. Automatic connection for rigid or flexible cables from 0.5 to 2.5mm2.		200	4,49 €
	High (mm): 58,2 Diameter (mm): 83 Colour: Gold Voltage In (Vac): 250 Temperature (°C): 180 Connection: Automatic Socket: E27 Reference: 041763			



	SK01038A		1	2,60 €
	White E27 curved base socket lamp holder		10	1,72 €
			50	1,59 €
	Thermoplastic. Connecting screws for rigid or flexible cables from 0.5 to 2.5mm2.		200	1,53 €
	Colour: White Voltage In (Vac): 250 Intensidad In (A): 4 Temperature (°C): 180 Connection: Automatic Socket: E27 Ingress Protection: IP20 Reference: 033801			



Subfamily **Halotec Light point thermoplastic lampholders E27**

Picture	Article	Description	Lot	Price/Unit
	SK01039A		1	2,59 €
	Black E27 curved base socket lamp holder		10	1,73 €
	Thermoplastic. Automatic connection for rigid or flexible cables from 0.5 to 2.5mm2.		50	1,60 €
			200	1,53 €
	Colour: Black Voltage In (Vac): 250 Intensidad In (A): 4 Temperature (°C): 180 Connection: Automatic Socket: E27 Ingress Protection: IP20 Reference: 033802			



	SK01041A		1	2,12 €
	Lampholder for plinth straight E27 white ARDITI		10	1,42 €
	Thermoplastic. Connecting screws for rigid or flexible cables 0.5 to 2.5mm2		50	1,31 €
			200	1,26 €
	Colour: White Voltage In (Vac): 250 Intensidad In (A): 4 Temperature (°C): 180 Connection: Automatic Socket: E27 Ingress Protection: IP20 Reference: 033804			



HALOTEC HARDWARE > Halotec Small Installation Material > Lampholders for Installing

Subfamily **Halotec Light point thermoplastic lampholders E27**

Picture	Article	Description	Lot	Price/Unit
	SK01042A		1	2,21 €
	Black E27 straight base socket lamp holder		10	1,48 €
	Thermoplastic. Connecting screws for rigid or flexible cables 0.5 to 2.5mm ²		50	1,35 €
			200	1,31 €
	Colour: Black Voltage In (Vac): 250 Intensidad In (A): 4 Temperature (°C): 180 Connection: Automatic Socket: E27 Ingress Protection: IP20 Reference: 033805			



 arditi
 LIGHTING INNOVATION

Catalogue **HALOTEC HARDWARE**
 Line **Halotec Small Installation Material**
 Family **Lampholders for Installing**
 Subfamily **Halotec Metal Lampholders E27**

Picture	Article	Description	Lot	Price/Unit
	SK01027		1	2,82 €
		Lampholder metallic E27 with shade ring	20	2,18 €
		Fixing M10x1 : metal screw with anti-rotation	60	1,98 €
		Colour: Zinc Voltage In (Vac): 250 Intensidad In (A): 4 Temperature (°C): 230 Connection: Screw Socket: E27		

arditi



	SK01027A		50 (Pedido mínimo)	1,95 €
		hreaded lampholder E27 galvanized metal mounted without washer	250	1,86 €
		Fixing M10x1: metal with anti-twist screw. For rigid or flexible cables of 0.5-2.5mm2. Grounded Colour: White zinc Voltage In (Vac): 250 Intensidad In (A): 4 Temperature (°C): 230 Connection: Screw Socket: E27		

arditi



Subfamily **Halotec Metal Lampholders E27**

Picture	Article	Description	Lot	Price/Unit
	SK01028		1	3,81 €
		Blister Lampholder metallic E27 with shade ring	12	2,94 €
		Fixing M10x1: metal screw with anti-rotation.	24	2,67 €
		Colour: Zinc Voltage In (Vac): 250 Intensidad In (A): 4 Temperature (°C): 230 Connection: Screw Socket: E27		



	SK01028A	E27 threaded socket brass metal washer mounted without washer	500 (Pedido mínimo)	2,38 €
--	----------	---	---------------------	--------



Image in another color

M10x1 fixing: metal with anti-rotation screw. For rigid or flexible cables of 0.5-2.5mm². With earth connection

Colour: Brass Voltage In (Vac): 250
Intensidad In (A): 4 Temperature (°C): 230
Connection: Screw Socket: E27

Reference: 035344





Subfamily **Halotec Metal Lampholders E27**

Picture	Article	Description	Lot	Price/Unit
	SK01029A		1	2,56 €
	E27 smooth brass metal mounted		250	2,42 €
		M10x1 fixing: metal with anti-rotation screw. For rigid or flexible cables of 0.5-2.5mm2. With earth connection		
		Colour: Brass Voltage In (Vac): 250 Intensidad In (A): 4 Temperature (°C): 230 Connection: Screw Socket: E27		
		Reference: 035842		
				
				

	SK01030A		1	2,39 €
	Lampholder smooth metal zinc mounted E27		250	2,26 €
		M10x1 fixing: metal with anti-rotation screw. For rigid or flexible cables of 0.5-2.5mm2. With earth connection		
		Colour: White zinc Voltage In (Vac): 250 Intensidad In (A): 4 Temperature (°C): 230 Connection: Screw Socket: E27		
		Image in another color		
				
				

Catalogue **HALOTEC HARDWARE**
 Line **Halotec Small Installation Material**
 Family **Lampholders for Installing**
 Subfamily **Halotec bakelite and thermoplastic Lampholders E14**

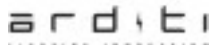
Picture	Article	Description	Lot	Price/Unit
	SK02001A		100 (Pedido mínimo)	0,4644 €
	Port. E14 smooth black thermoplastic mounted antigiro	M10x1 fixing. Screw connection	500	0,4472 €
		Colour: Black Voltage In (Vac): 250 Intensidad In (A): 2 Temperature (°C): 190 Socket: E14		
				
				

	SK02003A		100 (Pedido mínimo)	0,5820 €
	E14 smooth white thermoplastic lampholders mounted antigiro	M10x1.Conexión fixing screw	500	0,5625 €
		Colour: White Voltage In (Vac): 250 Intensidad In (A): 2 Temperature (°C): 190 Socket: E14		
		Reference: 031648		
				
				

Subfamily Halotec bakelite and thermoplastic Lampholders E14

Picture	Article	Description	Lot	Price/Unit
	SK02004		1	2,05 €
	Blister Lampholder plane E14 thermoplastic white antirotation		36	1,57 €
			72	1,42 €

Fixing M10x1: plastic screw with anti-rotation

Colour: White Voltage In (Vac): 250
Intensidad In (A): 2 Temperature (°C): 190
Connection: Screw Socket: E14



	SK02005		1	0,68 €
	Lampholder plane E14 bakelite black antirotation FILM+EAN		100	0,52 €
			500	0,47 €

Fixing M10x1 : metal screw with anti-rotation

Colour: Black Voltage In (Vac): 250
Intensidad In (A): 2 Temperature (°C): 190
Connection: Screw Socket: E14



HALOTEC HARDWARE > Halotec Small Installation Material > Lampholders for Installing

Subfamily Halotec bakelite and thermoplastic Lampholders E14

Picture	Article	Description	Lot	Price/Unit
	SK02006		1	0,75 €
	Blister Lampholder plane E14 bakelite black antirotation		36	0,57 €
			72	0,52 €

Fixing M10x1: metal screw with anti-rotation

Colour: Black Voltage In (Vac): 250
Intensidad In (A): 2 Temperature (°C): 190
Connection: Screw Socket: E14



	SK02007		1	0,70 €
	Smooth E14 lamp holder in white bakelite anti-rotation		100	0,52 €
			500	0,47 €



HALOTEC HARDWARE > Halotec Small Installation Material > Lampholders for Installing

Subfamily **Halotec bakelite and thermoplastic Lampholders E14**

Picture	Article	Description	Lot	Price/Unit
	SK02013		1	0,88 €
		Lampholder partly threaded E14 bakelite black	100	0,68 €
		antirotation FILM+EAN	500	0,61 €

Fixing M10x1 : metal screw with anti-rotation

Colour: Black Voltage In (Vac): 250
 Intensidad In (A): 2 Temperature (°C): 190
 Connection: Screw Socket: E14

Catalogue **HALOTEC HARDWARE**
 Line **Halotec Small Installation Material**
 Family **Lampholders for Installing**
 Subfamily **Halotec Halogen Lampholders GZ10**

Picture	Article	Description	Lot	Price/Unit
	SK02027		1	1,01 €
	Lampholder halogen GZ10 230V		25	0,87 €
	Soapstone. Connection cable 15cm double silicone layer for high temperature		200	0,83 €
	Colour: Porcelain Voltage In (Vac): 250 Intensidad In (A): 4 Temperature (°C): 250-180 Socket: GZ10			
	SK02028		1	1,74 €
	Blister Lampholder halogen GZ10 230V		12	1,60 €
		Soapstone. Connection cable 15cm double silicone layer for high temperature	24	1,56 €
		Colour: Porcelain Voltage In (Vac): 250 Intensidad In (A): 4 Temperature (°C): 250-180 Socket: GZ10		

arditi



HALOTEC®



Catalogue **HALOTEC HARDWARE**
 Line **Halotec Small Installation Material**
 Family **Lampholders for Installing**
 Subfamily **Halotec Halogen Low Voltage Lampholders**

Picture	Article	Description	Lot	Price/Unit
	SK02029		1	0,5855 €
	Lampholder halogen low voltage		50	0,4505 €
	Soapstone. Connection cable 16cm double silicone layer for high temperature		200	0,4053 €
	Colour: Ceramic Voltage In (Vdc/ac): 24 Intensidad In (A): 10 Temperature (°C): 300-180			



	SK02030		1	1,57 €
	Blister 2 units Lampholder halogen low voltage		12	1,26 €
	Soapstone. Connection cable 16cm double silicone layer for high temperature		24	1,14 €
	Colour: Ceramic Voltage In (Vdc/ac): 24 Intensidad In (A): 10 Temperature (°C): 300-180			



Catalogue **HALOTEC HARDWARE**
 Line **Halotec Small Installation Material**
 Family **Lampholders for Installing**
 Subfamily **Lampholder adapter**

Picture	Article	Description	Lot	Price/Unit
	SK01045		1	1,50 €
	GU10/E27 adapter socket White		25	1,35 €
		Interior material: Ceramic. Outer material: Polyester		50
	High (mm): 57 Diameter (mm): 35 Colour: White Voltage In (Vac): 250 Intensidad In (A): 2 Socket: GU10			



Catalogue **HALOTEC HARDWARE**
 Line **Halotec Small Installation Material**
 Family **Lampholders for Installing**
 Subfamily **Halotec lampholders and wreath accessories E27**



Picture	Article	Description	Lot	Price/Unit
	SK01046		1	1,30 €
	Lamp holder for garlands E27 socket black		10	1,20 €
	Thermostable material body (Polyamide). Connection by perforation, insulator (IP41 with washer ref. SK01050), for rectangular cable 5x11mm or 5.5x13mm, of section 2 x 2.5 mm ² . Indoor use		50	1,13 €
		High (mm): 50 Diameter (mm): 40 Colour: Black Voltage In (Vac): 250 Intensidad In (A): 4 Power (W): 40 Socket: E27		

Image in another color



	SK01047		1	10,62 €
	Fixing bracket for rectangular cable 5x11mm		5	9,66 €
	Material synthetic rubber / Rubber.		10	9,20 €
		Length (mm): 113 Diameter (mm): 43 Colour: Black Ingress Protection: IP44		



Subfamily **Halotec lampholders and wreath accessories E27**

Picture	Article	Description	Lot	Price/Unit
	SK01048		1	11,06 €
	Bipolar plug for rectangular cable 5x11mm		5	10,05 €
			10	9,58 €
	Material synthetic rubber / Rubber.			

Length (mm): 99 Diameter (mm): 42 Colour: Black
Voltage In (Vac): 250 Intensidad In (A): 16
Ingress Protection: IP44



	SK01049		1	19,02 €
	Bipolar mobile rubber base for garland for rectangular cable 5x11mm		5	17,29 €
			10	16,47 €
	Material synthetic rubber / Rubber.			

Length (mm): 118 Diameter (mm): 50 Colour: Black
Voltage In (Vac): 250 Intensidad In (A): 16
Ingress Protection: IP44



Subfamily **Halotec lampholders and wreath accessories E27**

Picture	Article	Description	Lot	Price/Unit
	SK01050		1	0,78 €
		Silicone sealing washer for garland lampholder	10	0,71 €
		Material: Resistant silicone. Internal diameter 28mm. For garland lampholder	40	0,68 €
		High (mm): 9 Diameter (mm): 42 Colour: Black Ingress Protection: IP44		



	SK01051		1	102,86 €
		10m garland with 12 lampholder E27 rectangular cable 5x11mm	2	93,50 €
		5x11mm halogen-free rectangular PVC cable. 10m long wreath with 12 E27 lampholders, 1 plug and 1 support. 1kV insulation	4	89,05 €
		Length (mm): 10000 Colour: Black		



HALOTEC HARDWARE > Halotec Small Installation Material > Lampholders for Installing

Subfamily **Halotec lampholders and wreath accessories E27**

Picture	Article	Description	Lot	Price/Unit
	SK01052	5x11mm Rectalgar Cable for Garland	50 (Pedido mínimo)	2,35 €
		5x11mm halogen-free rectangular PVC cable. 1kV insulation	100	2,15 €
		Length (mm): 5000 Colour: Black Room Temperature (°C): -5~+70	150	2,04 €



Catalogue **HALOTEC HARDWARE**
 Line **Halotec Small Installation Material**
 Family **Surface Mechanisms**
 Subfamily **Surface Mechanisms**

Picture	Article	Description	Lot	Price/Unit
	SK08325		1	1,52 €
	Blister Push-button		20	1,33 €
		Voltage In (Vac): 250 Intensidad In (A): 10~16	40	1,26 €



	SK08326		1	1,73 €
	Blister double Switch		20	1,51 €
		Voltage In (Vac): 250 Intensidad In (A): 10~16	40	1,43 €



HALOTEC HARDWARE > Halotec Small Installation Material > Surface Mechanisms

Subfamily **Surface Mechanisms**

Picture	Article	Description	Lot	Price/Unit
	SK08327		1	1,73 €
	Blister double Switch		20	1,51 €
	Voltage In (Vac): 250 Intensidad In (A): 10~16		40	1,43 €

HALOTEC®

CE



	SK08333		1	1,11 €
	Switch FILM+EAN		24	1,01 €
	Voltage In (Vac): 250 Intensidad In (A): 10~16		48	0,96 €

HALOTEC®

CE



HALOTEC HARDWARE > Halotec Small Installation Material > Surface Mechanisms

Subfamily **Surface Mechanisms**

Picture	Article	Description	Lot	Price/Unit
	SK08334		1	1,18 €
	Push-button FILM+EAN		40	1,04 €
	Voltage In (Vac): 250 Intensidad In (A): 10~16		80	0,99 €

HALOTEC®

CE



	SK08335		1	1,47 €
	double Switch FILM+EAN		40	1,27 €
	Voltage In (Vac): 250 Intensidad In (A): 10~16		80	1,21 €

HALOTEC®

CE



HALOTEC HARDWARE > Halotec Small Installation Material > Surface Mechanisms

Subfamily **Surface Mechanisms**

Picture	Article	Description	Lot	Price/Unit
	SK08336		1	1,53 €
	double Switch FILM+EAN		40	1,34 €
	Voltage In (Vac): 250 Intensidad In (A): 10~16		80	1,27 €



Catalogue **HALOTEC HARDWARE**
 Line **Halotec Small Installation Material**
 Family **Surface Mechanisms**
 Subfamily **Waterproof Surface Mechanisms IP54**

Picture	Article	Description	Lot	Price/Unit
	SK08701		1	3,12 €
		Blister Switch/conmutator IP54	6	2,60 €
		IP54 outdoor switch in blister	12	2,37 €
		Voltage In (Vac): 250 Intensidad In (A): 10		
	SK08702		1	3,38 €
		Blister Switch/conmutator IP54 with led diode	10	2,82 €
		Switch / Switch with outdoor signaling LED IP54 in blister	20	2,56 €
		Voltage In (Vac): 250 Intensidad In (A): 10		
				

Subfamily **Waterproof Surface Mechanisms IP54**

Picture	Article	Description	Lot	Price/Unit
	SK08704		1	5,76 €
	Blister Switch/conmutator and Schuko base covered IP54		10	4,81 €
			20	4,37 €

Base and switch / switch for outdoor IP54 in blister

Voltage In (Vac): 250 Intensidad In (A): 16



	SK08705		1	3,56 €
	Blister 2 Switches IP54		10	2,98 €
			20	2,70 €

Double switch for outdoor IP54 in blister

Voltage In (Vac): 250 Intensidad In (A): 10



Subfamily **Waterproof Surface Mechanisms IP54**

Picture	Article	Description	Lot	Price/Unit
	SK08706		1	6,14 €
		Blister 2 Switches con base Schuko covered IP54	6	5,11 €
		Double switch with covered Schuko base for outdoor IP54 in blister	12	4,65 €

Voltage In (Vac): 250 Intensidad In (A): 16







	SK08707		1	5,25 €
		Blister 2 bases Schuko covered IP54	10	4,38 €
		Double switch with covered Schuko base for outdoor IP54 in blister	20	3,98 €

Voltage In (Vac): 250 Intensidad In (A): 10



Subfamily **Waterproof Surface Mechanisms IP54**

Picture	Article	Description	Lot	Price/Unit
	SK08710	Base Plug Schuko covered IP54 FILM+EAN	1	2,13 €
		Voltage In (Vac): 250 Intensidad In (A): 16		
				
				

	SK08711	Switch/commutator and base Schuko covered IP54 FILM+EAN	1	5,24 €
			5	4,36 €
			20	3,97 €
				
				
				

HALOTEC HARDWARE > Halotec Small Installation Material > Surface Mechanisms

Subfamily **Waterproof Surface Mechanisms IP54**

Picture	Article	Description	Lot	Price/Unit
	SK08712		1	2,89 €
		Double Switch IP54 FILM+EAN	10	2,41 €
		Voltage In (Vac): 250 Intensidad In (A): 10	40	2,18 €

HALOTEC®

CE



	SK08713		1	5,33 €
		Double Switch with Schuko base covered IP54 FILM+EAN	5	4,45 €
		Voltage In (Vac): 250 Intensidad In (A): 16	20	4,04 €

HALOTEC®

CE



HALOTEC HARDWARE > Halotec Small Installation Material > Surface Mechanisms

Subfamily Waterproof Surface Mechanisms IP54





Picture	Article	Description	Lot	Price/Unit
	SK08715		1	1,96 €
		Pushbutton IP54 FILM+EAN	10	1,64 €
		Voltage In (Vac): 250 Intensidad In (A): 10	40	1,50 €

HALOTEC®



CE





Catalogue **HALOTEC HARDWARE**
 Line **Halotec Small Installation Material**
 FAmily **PLP Terminal Block for Installation**
 Subfamily **PLP Installation terminal blocks**



Picture	Article	Description	Lot	Price/Unit
	SK04101K	Terminal Block 432- PLP 4mm2. 12 Holes	10 (Pedido mínimo)	1,11 €
		Polypropylene auto-extinguishable UL94V2 homologated for working temperature 85 °C	50	1,00 €
		Section (mm2): 4 Voltage In (Vac): 450 Intensidad In (A): 32 Temperature (°C): 85 Reference: 4017510	100	0,96 €
				
	SK04102K	Terminal Block 433-PLP 6mm2. 12 Holes	10 (Pedido mínimo)	1,24 €
		Polypropylene auto-extinguishable UL94V2 homologated for working temperature 85 °C	50	1,13 €
		Section (mm2): 6 Voltage In (Vac): 450 Intensidad In (A): 41 Temperature (°C): 85 Reference: 4011510	300	1,08 €
				

Subfamily **PLP Installation terminal blocks**







Picture	Article	Description	Lot	Price/Unit
	SK04103K	Terminal Block 434-PLP 10mm2. 12 Holes	10 (Pedido mínimo)	1,50 €
		Polypropylene auto-extinguishable UL94V2 homologated for working temperature 85°C	50	1,38 €
		Section (mm2): 10 Voltage In (Vac): 450 Intensidad In (A): 57 Temperature (°C): 85	260	1,30 €
		Reference: 4013010		
	SK04104K	Terminal Block 435- PLP 16mm2. 12 Holes	10 (Pedido mínimo)	3,25 €
		Polypropylene self-extinguishing UL94V2 approved for working temperature of 85 ° C	50	2,94 €
		Section (mm2): 16 Voltage In (Vac): 450 Intensidad In (A): 76 Temperature (°C): 85	130	2,82 €
		Reference: 4014510		

Subfamily **PLP Installation terminal blocks**





Picture	Article	Description	Lot	Price/Unit
	SK04105K	Terminal Block 438-PLP 25mm2. 12 Holes	3 (Pedido mínimo)	7,31 €
		Polypropylene self-extinguishing UL94V2, approved for working temperature of 85 ° C	30 54	6,63 € 6,32 €
		Section (mm2): 25 Voltage In (Vac): 450 Intensidad In (A): 101 Temperature (°C): 85 Reference: 4016010		
				

	SK04106K	Connection strip 432-PLP 4mm2.Black, 12 pole	10 (Pedido mínimo)	1,11 €
		Polypropylene self-extinguishing UL94V2, approved for working temperature of 85 ° C	160 320	1,01 € 0,96 €
		Section (mm2): 4 Colour: Black Voltage In (Vac): 450 Intensidad In (A): 32 Temperature (°C): 85 Reference: 4017501		
				

Subfamily **PLP Installation terminal blocks**

Picture	Article	Description	Lot	Price/Unit
	SK04107K	Connection strip 433-PLP 6mm2.Black, 12 pole	10 (Pedido mínimo)	1,24 €
		Polypropylene self-extinguishing UL94V2, approved for working temperature of 85 ° C	50	1,13 €
		Section (mm2): 6 Colour: Black Voltage In (Vac): 450 Intensidad In (A): 41 Temperature (°C): 85	300	1,08 €
		Reference: 4011501		
		<hr/>		
	SK04108K	Connection strip 434-PLP 10mm2.Black, 12 pole	10 (Pedido mínimo)	1,50 €
		Polypropylene self-extinguishing UL94V2, approved for working temperature of 85 ° C	50	1,38 €
		Section (mm2): 10 Colour: Black Voltage In (Vac): 450 Intensidad In (A): 57 Temperature (°C): 85	260	1,30 €
		Reference: 4013001		
		<hr/>		

Subfamily **PLP Installation terminal blocks**

Picture	Article	Description	Lot	Price/Unit
	SK04109K	Connection strip 435-PLP 16mm2.Black, 12 pole	10 (Pedido mínimo)	3,25 €
		Polypropylene self-extinguishing UL94V2, approved for working temperature of 85 ° C	50	2,94 €
		Section (mm2): 16 Voltage In (Vac): 450 Intensidad In (A): 76 Temperature (°C): 85	130	2,82 €
		Reference: 4014501		
				
	SK04110K	Connection strip 438-PLP 25mm2.Black, 12 pole	3 (Pedido mínimo)	7,25 €
		Polypropylene self-extinguishing UL94V2, approved for working temperature of 85 ° C	30	6,59 €
		Section (mm2): 25 Colour: Black Voltage In (Vac): 450 Intensidad In (A): 101 Temperature (°C): 85	54	6,28 €
		Reference: 4016001		
				

Catalogue **HALOTEC HARDWARE**
 Line **Halotec Small Installation Material**
 Family **Detectors And Meters**
 Subfamily **Detectors**

Picture	Article	Description	Lot	Price/Unit
	SK08603		1	15,28 €
	Switch Infrared motion		5	12,73 €
	Slot-in small box, detect movements, sounds and light.Adjusts the sensibility, time,sounds and light		10	11,57 €
	Voltage In (Vac): 230 Frecuency (Hz): 50			



Catalogue **HALOTEC HARDWARE**
Line **Halotec Small Installation Material**
FAMILY **Ringers, Programmers and Alarms**
Subfamily **Alarms**



Picture	Article	Description	Lot	Price/Unit
---------	---------	-------------	-----	------------

Catalogue **HALOTEC HARDWARE**
 Line **Halotec Small Installation Material**
 Family **Ringers, Programmers and Alarms**
 Subfamily **Mechanical Programmers**

Picture	Article	Description	Lot	Price/Unit
	SK08310		1	5,92 €
		Mechanical programmers daily 24 hours	10	5,38 €
		Maxi 3500W, instructions included. Contains 48 programs	20	5,14 €
		Voltage In (Vac): 230 Frecuency (Hz): 50		



Catalogue **HALOTEC HARDWARE**
 Line **Halotec Small Installation Material**
 Family **Electronic Ultrasonic Repeller**
 Subfamily **Electronic Ultrasonic Repeller**

Picture	Article	Description	Lot	Price/Unit
	SK08801		1	9,19 €
	Animal Repeller		10	8,36 €
		Emits an audible sound which takes away animals, 3 types of frequencies to be chosen	20	7,96 €
		Voltage In (Vac): 220		
	 			
	SK08802		1	6,49 €
	Cockroach Repeller		10	5,90 €
		Repels cockroaches, emits an inaudible sound which scares off insects	20	5,62 €
		Voltage In (Vac): 220		
	 			