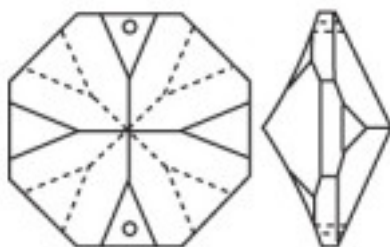


Catalogue **CRISTAL POUR LAMPES**
Ligne **SCHOLER CRYSTAL AUTRICHIEN**
Famille **LIGNE SCHÖLER ASFOUR**

Sous famille **Octogones et carrés "Asfour"**

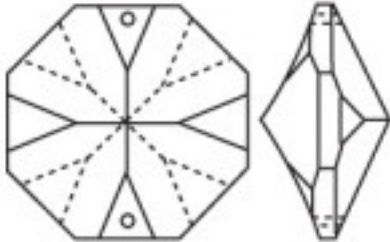
Photo	Article	Description	Lot	Prix unitaire
	E0050476		144 (Pedido mínimo)	1,37 €
	Allonge A.0504 76x18mm Asfour cristal	Longueur (mm): 76 Largeur (mm): 18 Couleur: Transparent		



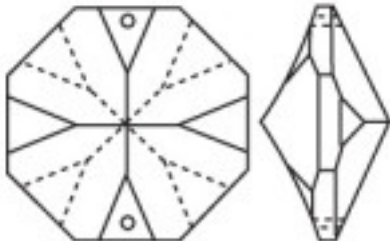
	E0108014		1	0,14 €
	Octogone 1080/14mm Asfour cristal 2 trous		250	0,0953 €
	Longueur (mm): 14 Couleur: Transparent		2000	0,0477 €



Sous famille **Octogones et carrés "Asfour"**

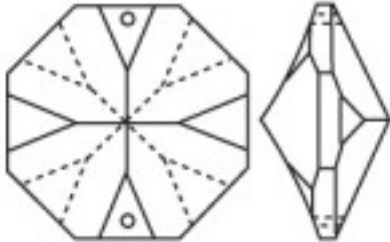
Photo	Article	Description	Lot	Prix unitaire
	E0108016		1	0,2679 €
	Octogone 1080/16mm Asfour cristal 2 trous		108	0,1789 €
	Longueur (mm): 16 Couleur: Transparent		1188	0,1552 €



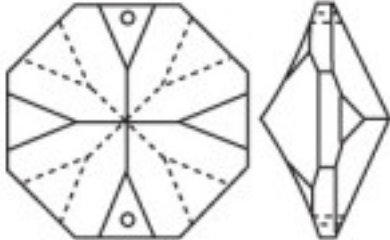
	E0108018		960 (Pedido mínimo)	0,2172 €
	Octogone 1080/18mm Asfour cristal 2 trous			
	Longueur (mm): 18 Couleur: Transparent			



Sous famille **Octogones et carrés "Asfour"**

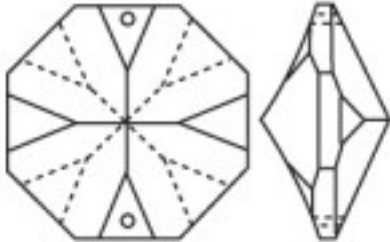
Photo	Article	Description	Lot	Prix unitaire
	E0108020		1	0,5938 €
	Octogone 1080/20mm Asfour cristal 2 trous		65	0,3961 €
	Longueur (mm): 20 Couleur: Transparent		585	0,3440 €



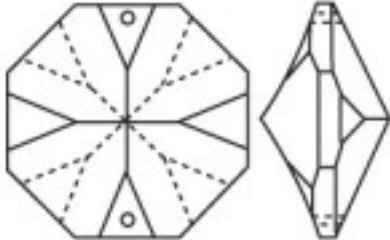
	E0108022		1	0,65 €
	Octogone 1080/22mm Asfour cristal 2 trous		65	0,4349 €
	Longueur (mm): 22 Couleur: Transparent		520	0,3775 €



Sous famille **Octogones et carrés "Asfour"**

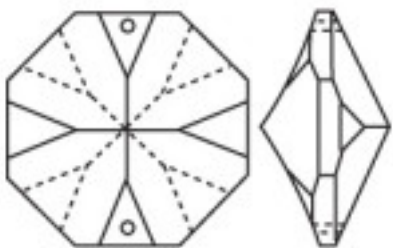

Photo	Article	Description	Lot	Prix unitaire
	E0108024		1	0,78 €
	Octogone 1080/24mm Asfour cristal 2 trous		46	0,5181 €
	Longueur (mm): 24 Couleur: Transparent		368	0,4499 €

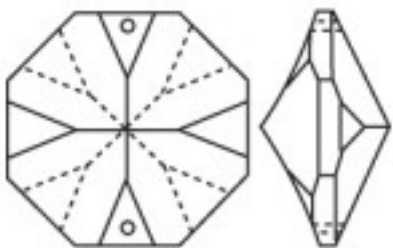



	E0108026		1	1,01 €
	Octogone 1080/26mm Asfour cristal 2 trous		44	0,68 €
	Longueur (mm): 26 Couleur: Transparent		308	0,5922 €

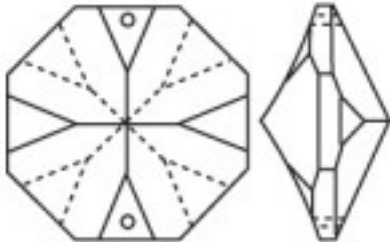





Sous famille **Octogones et carrés "Asfour"**

Photo	Article	Description	Lot	Prix unitaire
	E0108028	Octogone 1080/28mm Asfour cristal 2 trous	308 (Pedido mínimo)	0,67 €
	Longueur (mm): 28 Couleur: Transparent			
				

	E0108030	Octogone 1080/30mm Asfour cristal 2 trous	180 (Pedido mínimo)	0,79 €
	Longueur (mm): 30 Couleur: Transparent			
				

Sous famille **Octogones et carrés "Asfour"**

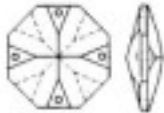
Photo	Article	Description	Lot	Prix unitaire
	E0108032		162 (Pedido mínimo)	1,01 €
	Octogone 1080/32mm Asfour cristal 2 trous	Longueur (mm): 32 Couleur: Transparent		
				

	E0108316		1188 (Pedido mínimo)	0,1552 €
	Octogone 1083/16mm Asfour cristal 3 trous	Longueur (mm): 16 Couleur: Transparent		
				

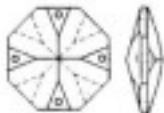
CRISTAL POUR LAMPES > SCHOLER CRYSTAL AUTRICHIEN > LIGNE SCHÖLER ASFOUR

Sous famille **Octogones et carrés "Asfour"**

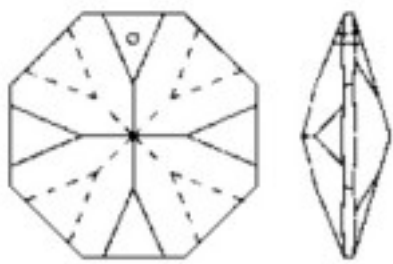

Photo	Article	Description	Lot	Prix unitaire
	E0108422	Octogone 1084/22mm Asfour cristal 4 trous	520 (Pedido mínimo)	0,3761 €
		Longueur (mm): 22 Couleur: Transparent		

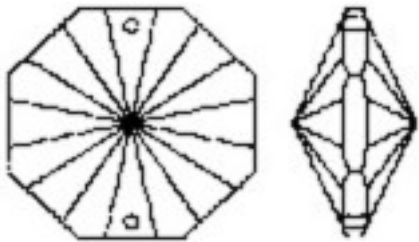



	E0108424	Octogone 1084/24mm Asfour cristal 4 trous	368 (Pedido mínimo)	0,4499 €
		Longueur (mm): 24 Couleur: Transparent		



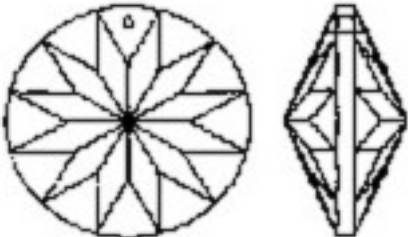
Sous famille **Octogones et carrés "Asfour"**

Photo	Article	Description	Lot	Prix unitaire
	E0108114	Octogone 1081/14mm Asfour cristal 1 trou	2000 (Pedido mínimo)	0,0828 €
	Longueur (mm): 14 Couleur: Transparent			
				

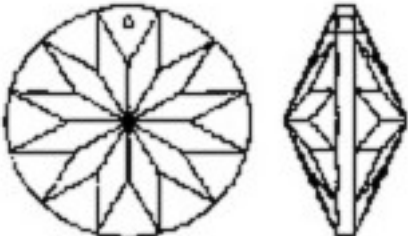
	E0103214	Octogone 1032/14mm Asfour cristal 2 trous	2000 (Pedido mínimo)	0,1242 €
	Longueur (mm): 14 Couleur: Transparent			
				

CRISTAL POUR LAMPES > SCHOLER CRYSTAL AUTRICHIEN > LIGNE SCHÖLER ASFOUR

Sous famille **Octogones et carrés "Asfour"**

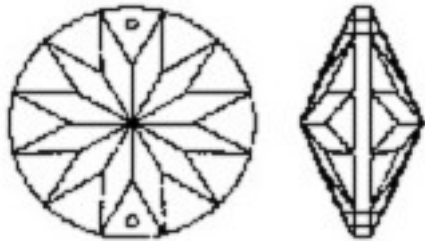

Photo	Article	Description	Lot	Prix unitaire
	E0104140		1	3,03 €
		Octogone 1041/40mm Asfour cristal 1 trou	17	2,03 €
		Diamètre (mm): 40 Couleur: Transparent	85	1,76 €

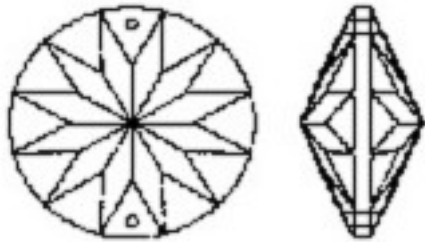



	E0104145		68 (Pedido mínimo)	2,76 €
		Octogone 1041/45mm Asfour cristal 1 trou		
		Diamètre (mm): 45 Couleur: Transparent		



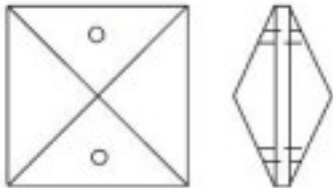

Sous famille **Octogones et carrés "Asfour"**

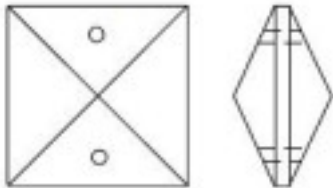

Photo	Article	Description	Lot	Prix unitaire
	E0104040	Octogone 1040/40mm Asfour cristal 2 trous	85 (Pedido mínimo)	1,51 €
	Diamètre (mm): 40 Couleur: Transparent			
				

	E0104045	Octogone 1040/45mm Asfour cristal 2 trous	68 (Pedido mínimo)	2,43 €
	Diamètre (mm): 45 Couleur: Transparent			
				

CRISTAL POUR LAMPES > SCHOLER CRYSTAL AUTRICHIEN > LIGNE SCHÖLER ASFOUR

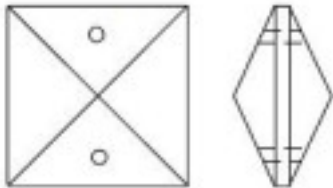

Sous famille **Octogones et carrés "Asfour"**

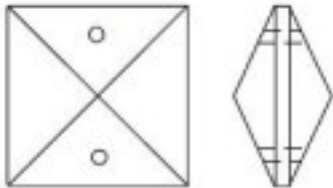

Photo	Article	Description	Lot	Prix unitaire
	E0202016	Carré 2020/16mm Asfour cristal 2 trous	1188 (Pedido mínimo)	0,2431 €
	Longueur (mm): 16 Couleur: Transparent			
				

	E0202018	Carré 2020/18mm Asfour cristal 2 trous	960 (Pedido mínimo)	0,2999 €
	Longueur (mm): 18 Couleur: Transparent			
				

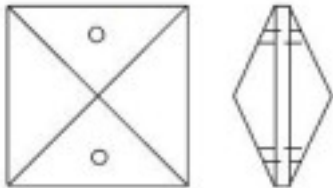

CRISTAL POUR LAMPES > SCHOLER CRYSTAL AUTRICHIEN > LIGNE SCHÖLER ASFOUR

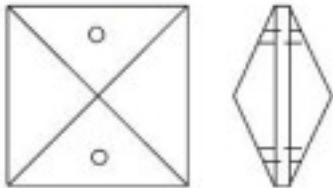

Sous famille **Octogones et carrés "Asfour"**

Photo	Article	Description	Lot	Prix unitaire
	E0202020	Carré 2020/20mm Asfour cristal 2 trous	585 (Pedido mínimo)	0,3440 €
	Longueur (mm): 20 Couleur: Transparent			
				

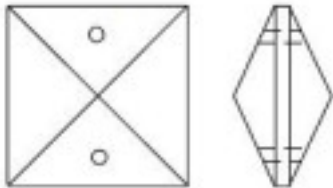

	E0202022	Carré 2020/22mm Asfour cristal 2 trous	520 (Pedido mínimo)	0,4291 €
	Longueur (mm): 22 Couleur: Transparent			
				

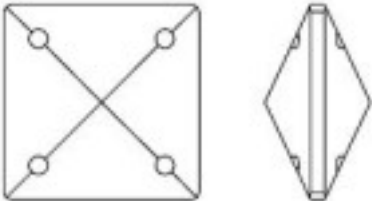

Sous famille **Octogones et carrés "Asfour"**

Photo	Article	Description	Lot	Prix unitaire
	E0202024	Carré 2020/24mm Asfour cristal 2 trous	308 (Pedido mínimo)	0,5507 €
	Longueur (mm): 24 Couleur: Transparent			
				

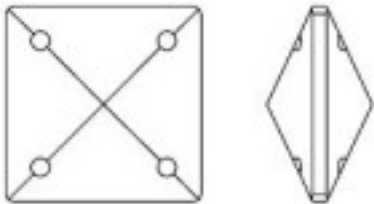
	E0202026	Carré 2020/26mm Asfour cristal 2 trous	308 (Pedido mínimo)	0,65 €
	Longueur (mm): 26 Couleur: Transparent			
				

Sous famille **Octogones et carrés "Asfour"**

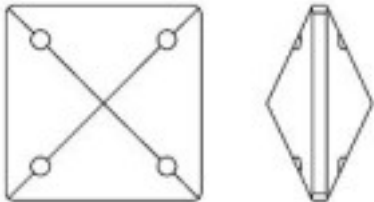
Photo	Article	Description	Lot	Prix unitaire
	E0202028	Carré 2020/28mm Asfour cristal 2 trous	264 (Pedido mínimo)	0,72 €
	Longueur (mm): 28 Couleur: Transparent			
				

	E0202422	Carré 2024/22mm Asfour cristal 4 trous	520 (Pedido mínimo)	0,4291 €
	Longueur (mm): 22 Couleur: Transparent			
				

Sous famille **Octogones et carrés "Asfour"**

Photo	Article	Description	Lot	Prix unitaire
	E0202424		1	0,96 €
	Carré 2024/24mm Asfour cristal 4 trous		77	0,63 €
	Longueur (mm): 24 Largeur (mm): 24		308	0,5507 €

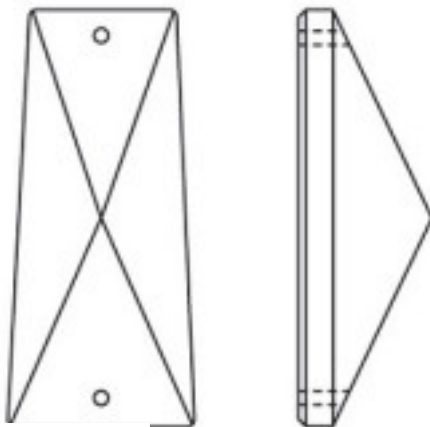

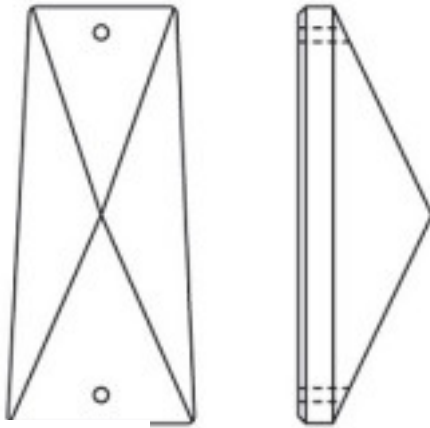



	E0202428		264 (Pedido mínimo)	0,72 €
	Carré 2024/28mm Asfour cristal 4 trous			
	Longueur (mm): 28 Couleur: Transparent			

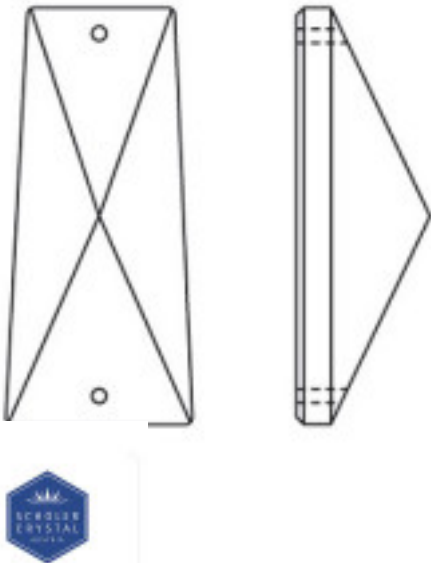
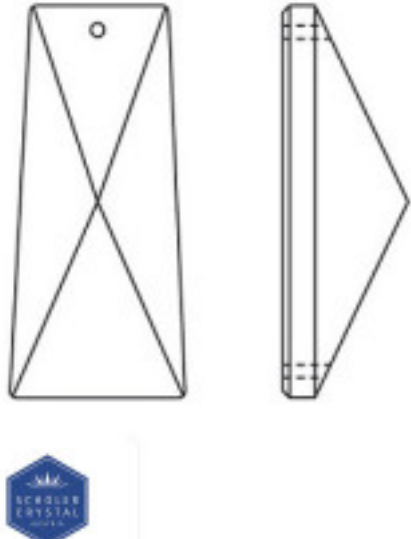


Catalogue **CRISTAL POUR LAMPES**
 Ligne **SCHOLER CRYSTAL AUTRICHIEN**
 Famille **LIGNE SCHÖLER ASFOUR**


Sous famille **Rallonges "Asfour"**

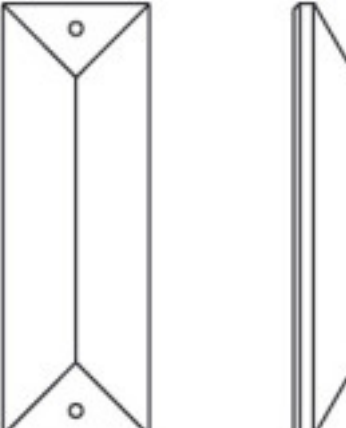

Photo	Article	Description	Lot	Prix unitaire
 	E0060450	Allonge 0604/50x18mm Asfour cristal 2 trous	324 (Pedido mínimo)	1,05 €
		Longueur (mm): 52 Largeur (mm): 18 Couleur: Transparent		
 	E0060458	Allonge 0604/58x26mm Asfour cristal 2 trous	1 24 168	2,39 € 1,57 € 1,38 €
		Longueur (mm): 58 Largeur (mm): 26 Couleur: Transparent		

Sous famille Rallonges "Asfour"

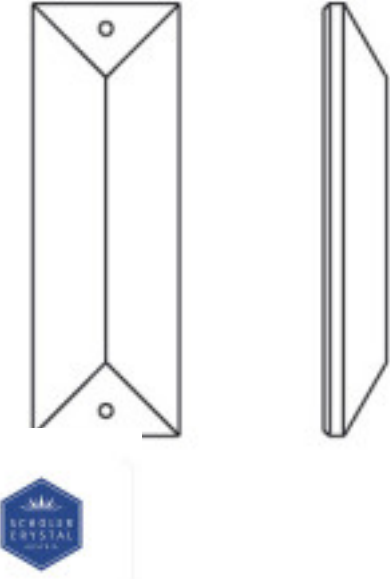
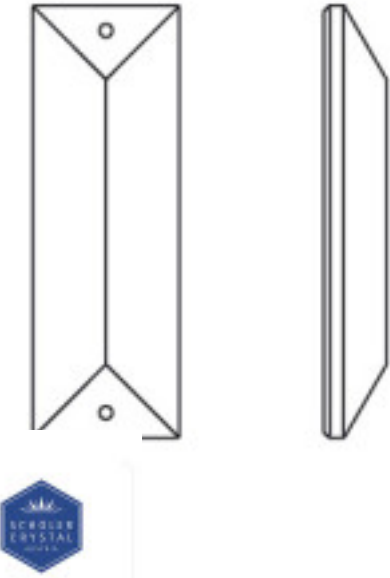
Photo	Article	Description	Lot	Prix unitaire
	<p>E0060463 Allonge 0604/63x30mm Asfour cristal 2 trous</p>	<p>Longueur (mm): 63 Largeur (mm): 30 Couleur: Transparent</p>	<p>100 (Pedido mínimo)</p>	<p>1,81 €</p>
	<p>E0060550 Allonge 0605/50x18mm Asfour cristal 1 trou</p>	<p>Longueur (mm): 52 Largeur (mm): 18 Couleur: Transparent</p>	<p>324 (Pedido mínimo)</p>	<p>1,05 €</p>

Sous famille **Rallonges "Asfour"**

Photo	Article	Description	Lot	Prix unitaire
	E0060650		324 (Pedido mínimo)	1,05 €
	Allonge 0606/50x18mm Asfour cristal 1 trou Longueur (mm): 52 Largeur (mm): 18 Couleur: Transparent			
				

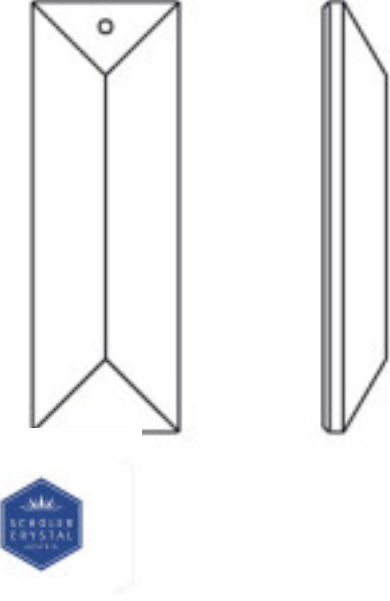
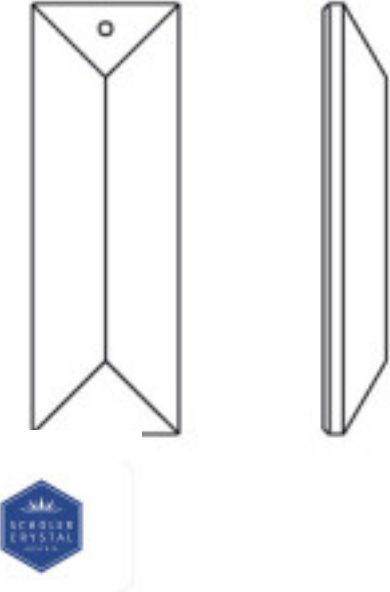
	E0061063		1	2,11 €
	Rectangle 0610/63x22mm Asfour cristal 2 trous Longueur (mm): 63 Largeur (mm): 22 Couleur: Transparent		25	1,40 €
			175	1,24 €

Sous famille **Rallonges "Asfour"**

Photo	Article	Description	Lot	Prix unitaire
	E0061076	Rectangle 0610/76x22mm Asfour cristal 2 trous Longueur (mm): 76 Largeur (mm): 22 Couleur: Transparent	128 (Pedido mínimo)	1,42 €
	E0061097	Rectangle 0610/200x28mm Asfour cristal 2 trous Longueur (mm): 200 Largeur (mm): 28 Couleur: Transparent	15 (Pedido mínimo)	9,35 €

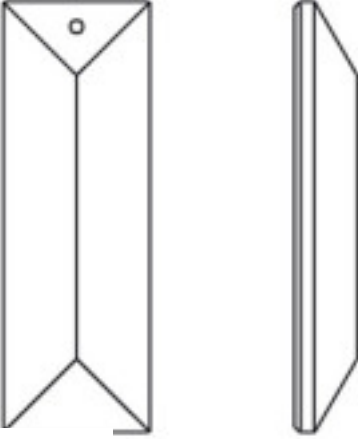

CRISTAL POUR LAMPES > SCHOLER CRYSTAL AUTRICHIEN > LIGNE SCHÖLER ASFOUR

Sous famille Rallonges "Asfour"

Photo	Article	Description	Lot	Prix unitaire
	E0061163	Rectangle 0611/63x22mm Asfour cristal 1 trou Longueur (mm): 63 Largeur (mm): 22 Couleur: Transparent	175 (Pedido mínimo)	1,24 €
	E0061176	Rectangle 0611/76x22mm Asfour cristal 1 trou Longueur (mm): 76 Largeur (mm): 22 Couleur: Transparent	128 (Pedido mínimo)	1,42 €



CRISTAL POUR LAMPES > SCHOLER CRYSTAL AUTRICHIEN > LIGNE SCHÖLER ASFOUR

Sous famille Rallonges "Asfour"



Photo	Article	Description	Lot	Prix unitaire
	E0061190	Rectangle 0611/100x28mm Asfour cristal 1 trou	50 (Pedido mínimo)	2,94 €
		Longueur (mm): 100 Largeur (mm): 28 Couleur: Transparent		



Catalogue **CRISTAL POUR LAMPES**
 Ligne **SCHOLER CRYSTAL AUTRICHIEN**
 Famille **LIGNE SCHÖLER ASFOUR**
 Sous famille **Boules "Asfour"**

Photo	Article	Description	Lot	Prix unitaire
	E0020590		1	9,76 €
	Bola A, cristal Asfour 0205 / 100x85 mm			
	Diamètre (mm): 100 Couleur: Transparent			
				



	E0070120		260 (Pedido mínimo)	1,30 €
	Perle 0701/20mm Asfour cristal			
	Diamètre (mm): 20 Couleur: Transparent			
				



Sous famille **Boules "Asfour"**

Photo	Article	Description	Lot	Prix unitaire
	E0070130		1	2,38 €
	Perle 0701/30mm Asfour cristal		30	1,60 €
	Diamètre (mm): 30 Couleur: Transparent		90	1,38 €
				


	E0070140		1	3,94 €
	Boule 0701/40mm Asfour cristal		20	2,63 €
	Diamètre (mm): 40 Couleur: Transparent		40	2,29 €
				


Sous famille **Boules "Asfour"**

Photo	Article	Description	Lot	Prix unitaire
	E0070150	Boule 0701/50mm Asfour cristal	12 (Pedido mínimo)	7,02 €
		Diamètre (mm): 50 Couleur: Transparent		
				

	E0070160	Boule 0701 / 60mm cristal Asfour	4 (Pedido mínimo)	13,85 €
		Diamètre (mm): 60 Couleur: Transparent		
				



Sous famille **Boules "Asfour"**

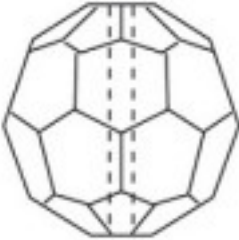

Photo	Article	Description	Lot	Prix unitaire
	E0070170		1	31,34 €
	Boule 0701/70mm Asfour cristal		4	27,25 €
	Diamètre (mm): 70 Couleur: Transparent			

	E0070190		3 (Pedido mínimo)	175,90 €
	Boule 0701/100mm Asfour cristal			
	Diamètre (mm): 100 Couleur: Transparent			

CRISTAL POUR LAMPES > SCHOLER CRYSTAL AUTRICHIEN > LIGNE SCHÖLER ASFOUR

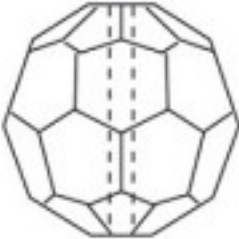
Sous famille **Boules "Asfour"**

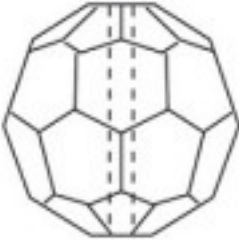
Photo	Article	Description	Lot	Prix unitaire
 	E0150206	Perle percée 1502/6mm Asfour cristal	8820 (Pedido mínimo)	0,1060 €
	Diamètre (mm): 6 Couleur: Transparent			

 	E0150208	Perle percée 1502/8mm Asfour cristal	1936 (Pedido mínimo)	0,1268 €
	Diamètre (mm): 8 Couleur: Transparent			

CRISTAL POUR LAMPES > SCHOLER CRYSTAL AUTRICHIEN > LIGNE SCHÖLER ASFOUR

Sous famille **Boules "Asfour"**

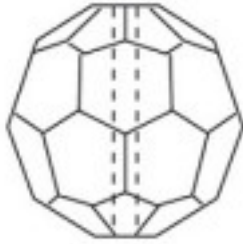
Photo	Article	Description	Lot	Prix unitaire
	E0150210	Perle percée 1502/10mm Asfour cristal	1350 (Pedido mínimo)	0,1629 €
	Diamètre (mm): 10 Couleur: Transparent			

	E0150212	Perle percée 1502/12mm Asfour cristal	1	0,3708 €
	Diamètre (mm): 12 Couleur: Transparent		100	0,2471 €
			1400	0,2146 €

CRISTAL POUR LAMPES > SCHOLER CRYSTAL AUTRICHIEN > LIGNE SCHÖLER ASFOUR

Sous famille **Boules "Asfour"**



Photo	Article	Description	Lot	Prix unitaire
	E0150214	Perle percée 1502/14mm Asfour cristal	840 (Pedido mínimo)	0,3335 €
		Diamètre (mm): 14 Couleur: Transparent		



Catalogue **CRISTAL POUR LAMPES**
Ligne **SCHOLER CRYSTAL AUTRICHIEN**
Famille **LIGNE SCHÖLER ASFOUR**



Sous famille **Prismes "Asfour"**

Photo	Article	Description	Lot	Prix unitaire
	E0040138		1	0,5810 €
	Prisme 0401/38x14mm Asfour cristal		60	0,3873 €
	Longueur (mm): 38 Largeur (mm): 14 Couleur: Transparent		420	0,3362 €
				

	E0040176		1	3,29 €
	Prisme 0401/76X17m Asfour crystal		20	2,22 €
	Longueur (mm): 76 Largeur (mm): 17 Couleur: Transparent		140	1,89 €
				

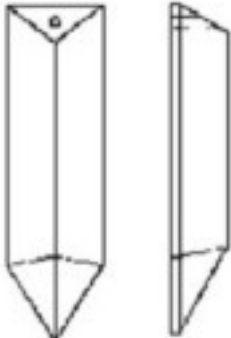

Sous famille Prismes "Asfour"

Photo	Article	Description	Lot	Prix unitaire
 	E0040520	Prisme 0405/20x11mm Asfour cristal	880 (Pedido mínimo)	0,2457 €
	Longueur (mm): 20 Largeur (mm): 11 Couleur: Transparent			

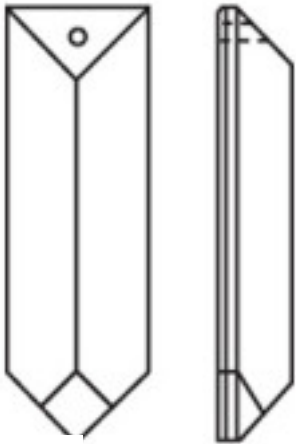
 	E0043220	Prisme 0432/20x11mm Asfour cristal	880 (Pedido mínimo)	0,2275 €
	Longueur (mm): 20 Largeur (mm): 11 Couleur: Transparent			

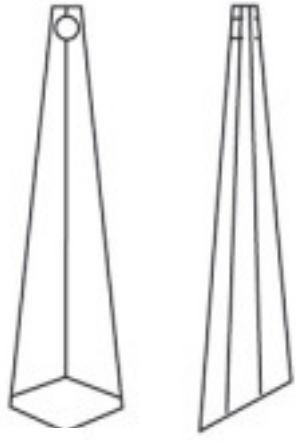
Sous famille Prismes "Asfour"

Photo	Article	Description	Lot	Prix unitaire
	E0043238		1	0,73 €
	Prisme 0432/38x12mm Asfour cristal		60	0,4833 €
	Longueur (mm): 38 Largeur (mm): 12 Couleur: Transparent		480	0,4202 €
				

	E0050289		119 (Pedido mínimo)	1,90 €
	Prisme 0502/89x20mm Asfour cristal	Longueur (mm): 89 Largeur (mm): 20 Couleur: Transparent		
				

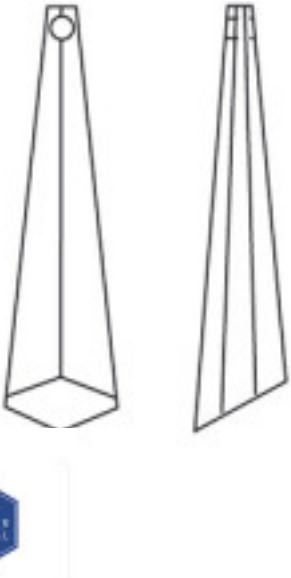
Sous famille Prismes "Asfour"

Photo	Article	Description	Lot	Prix unitaire
	E0050463	Prisme 0504/63x18mm Asfour cristal	210 (Pedido mínimo)	0,87 €
		Longueur (mm): 63 Largeur (mm): 18 Couleur: Transparent		

	E0050563	Prisme 0505/63x18mm Asfour cristal	175 (Pedido mínimo)	1,20 €
		Longueur (mm): 63 Largeur (mm): 18 Couleur: Transparent		

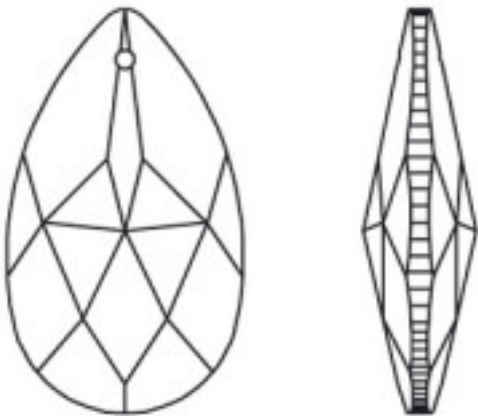
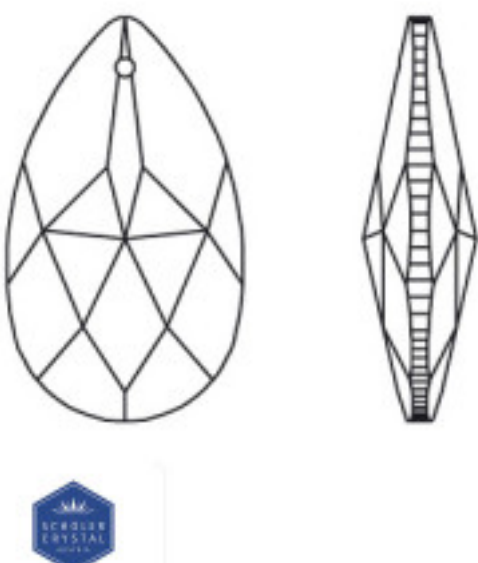
CRISTAL POUR LAMPES > SCHOLER CRYSTAL AUTRICHIEN > LIGNE SCHÖLER ASFOUR

Sous famille Prismes "Asfour"

Photo	Article	Description	Lot	Prix unitaire
	E0050576	Prisme 0505/76x20mm Asfour cristal	140 (Pedido mínimo)	1,59 €
		Longueur (mm): 76 Largeur (mm): 20 Couleur: Transparent		

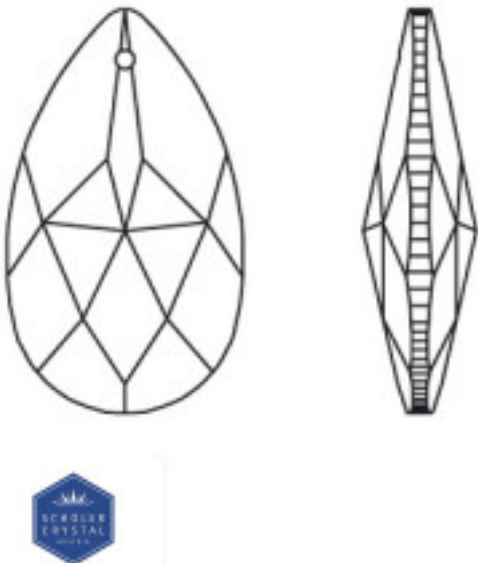
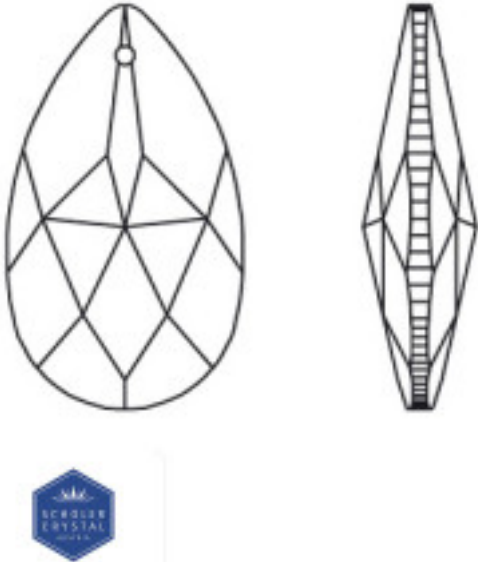
Catalogue **CRISTAL POUR LAMPES**
Ligne **SCHOLER CRYSTAL AUTRICHIEN**
Famille **LIGNE SCHÖLER ASFOUR**

Sous famille **Amandes "Asfour"**

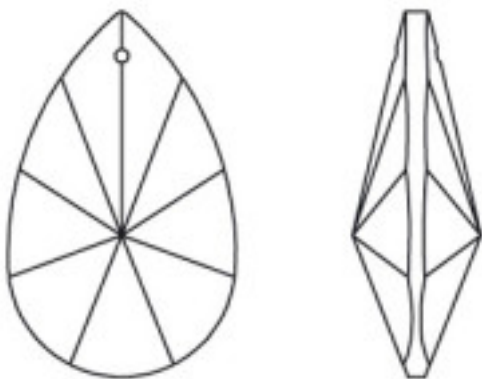



Photo	Article	Description	Lot	Prix unitaire
	E0087238	Amande 0872/38x22mm Asfour cristal	308 (Pedido mínimo)	1,04 €
	Longueur (mm): 38 Largeur (mm): 22 Couleur: Transparent			
	E0087250	Amande 0872/50x29mm Asfour cristal	1 27 135	2,15 € 1,43 € 1,22 €
	Longueur (mm): 50 Largeur (mm): 29 Couleur: Transparent			

CRISTAL POUR LAMPES > SCHOLER CRYSTAL AUTRICHIEN > LIGNE SCHÖLER ASFOUR

Sous famille **Amandes "Asfour"**

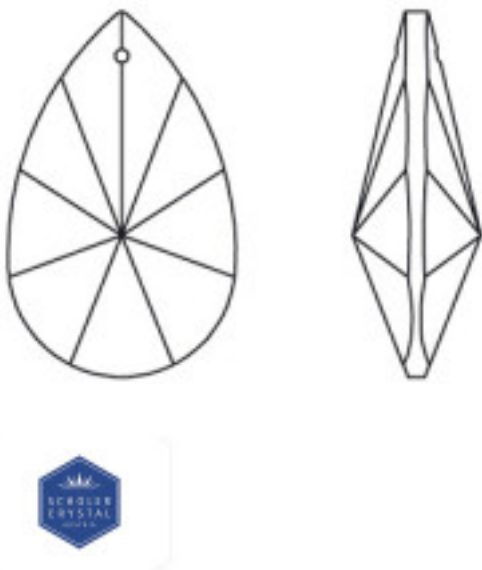

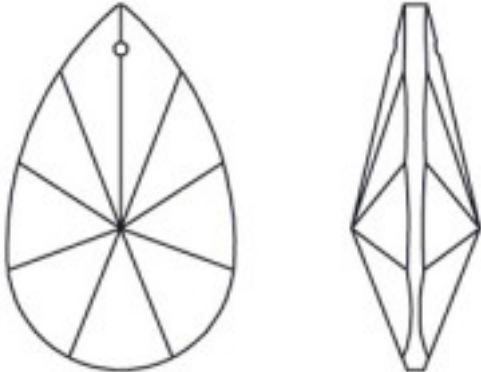

Photo	Article	Description	Lot	Prix unitaire
	E0087263 Amande 0872/63x37mm Asfour cristal	Longueur (mm): 63 Largeur (mm): 37 Couleur: Transparent	72 (Pedido mínimo)	2,68 €
	E0087276 Amande 0872/76x44mm Asfour cristal	Longueur (mm): 76 Largeur (mm): 44 Couleur: Transparent	40 (Pedido mínimo)	4,68 €

Sous famille **Amandes "Asfour"**

Photo	Article	Description	Lot	Prix unitaire
	E0087328	Amande 0873/28x17mm Asfour cristal	504 (Pedido mínimo)	0,67 €
		Longueur (mm): 28 Largeur (mm): 17 Couleur: Transparent		
				
	E0087338	Amande 0873/38x22mm Asfour cristal	1 44 308	1,57 € 1,04 € 0,90 €
		Longueur (mm): 38 Largeur (mm): 22 Couleur: Transparent		
				







CRISTAL POUR LAMPES > SCHOLER CRYSTAL AUTRICHIEN > LIGNE SCHÖLER ASFOUR

Sous famille **Amandes "Asfour"**

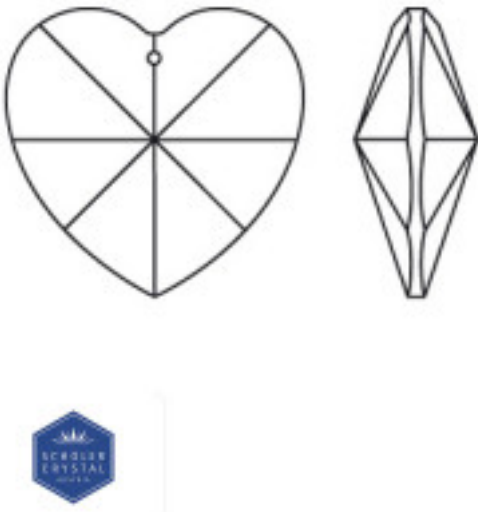
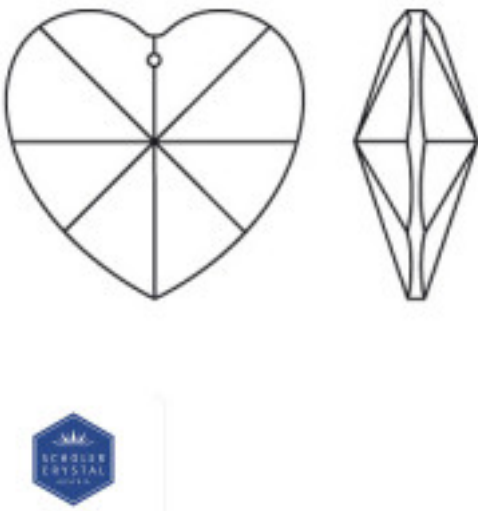
Photo	Article	Description	Lot	Prix unitaire
 	E0087350 Amande 0873/50x29mm Asfour cristal	Longueur (mm): 50 Largeur (mm): 29 Couleur: Transparent	135 (Pedido mínimo)	1,16 €
 	E0087363 Amande 0873/63x37mm Asfour cristal	Longueur (mm): 63 Largeur (mm): 37 Couleur: Transparent	72 (Pedido mínimo)	2,44 €

CRISTAL POUR LAMPES > SCHOLER CRYSTAL AUTRICHIEN > LIGNE SCHÖLER ASFOUR

Sous famille **Amandes "Asfour"**

Photo	Article	Description	Lot	Prix unitaire
  	E0087376	Amande 0873/76x44mm Asfour cristal	30 (Pedido mínimo)	4,08 €
	Longueur (mm): 76 Largeur (mm): 44 Couleur: Transparent			
  	E0087389	Amande 0873/89x52mm Asfour cristal	1 8 24	9,83 € 6,53 € 5,68 €
	Longueur (mm): 89 Largeur (mm): 52 Couleur: Transparent			

Sous famille **Amandes "Asfour"**

Photo	Article	Description	Lot	Prix unitaire
	E0087028 Pendentif Coeur 0870/28mm Asfour cristal	Longueur (mm): 28 Largeur (mm): 28 Couleur: Transparent	308 (Pedido mínimo)	0,75 €
	E0087040 Pendentif Coeur 0870/40mm Asfour cristal	Longueur (mm): 40 Largeur (mm): 40 Couleur: Transparent	100 (Pedido mínimo)	1,34 €

Catalogue **CRISTAL POUR LAMPES**
 Ligne **SCHOLER CRYSTAL AUTRICHIEN**
 Famille **LIGNE SCHÖLER ASFOUR**

Sous famille **Plaquettes "Asfour"**

Photo	Article	Description	Lot	Prix unitaire
	E000125	Bras rainé A.0001.250mm embout doré	1	15,52 €
		Longueur (mm): 250 Couleur: Transparent		



	E000136	Bras rainé A.0001 360mm embout chrome	1	18,11 €
		bouchon d'or		
		Longueur (mm): 360 Couleur: Transparent		

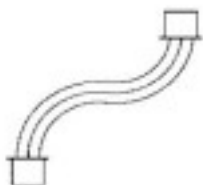


Sous famille **Plaquettes "Asfour"**

Photo	Article	Description	Lot	Prix unitaire
	E000230	Bras A.0002 300mm verre torsadé embout chrome	1	17,06 €
		Longueur (mm): 300 Couleur: Transparent		






	E000320	Bras A.0003 200mm verre torsadé embout chrome	1	10,41 €
		Longueur (mm): 200 Couleur: Transparent		



CRISTAL POUR LAMPES > SCHOLER CRYSTAL AUTRICHIEN > LIGNE SCHÖLER ASFOUR



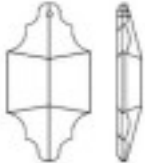

Sous famille **Plaquettes "Asfour"**

Photo	Article	Description	Lot	Prix unitaire
	E000420	Bras A.0004 200mm verre torsadé embout chrome	1	13,44 €
		Longueur (mm): 200 Couleur: Transparent		
				

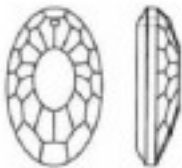

	E000530	Bras A.0005 300mm verre torsadé embout doré	1	19,40 €
		Crystal diamètre 19mm. Douille 24mm diamètre.		
		Longueur (mm): 300 Couleur: Doré		
				

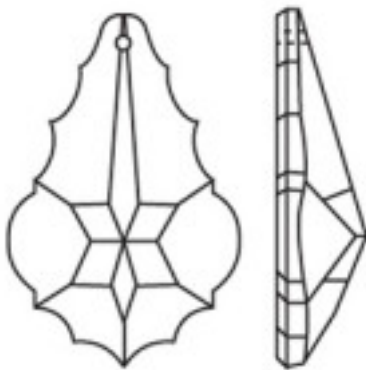

CRISTAL POUR LAMPES > SCHOLER CRYSTAL AUTRICHIEN > LIGNE SCHÖLER ASFOUR

Sous famille Plaquettes "Asfour"

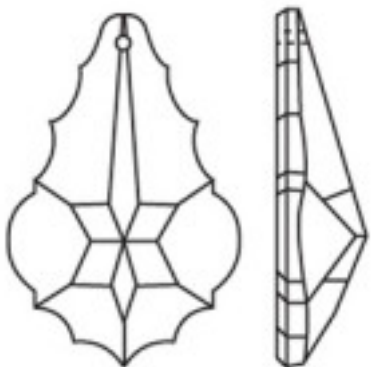

Photo	Article	Description	Lot	Prix unitaire
 	E002236A	Brass Torsadé A.0022 360x19mm Chrome cap Asfour crystal Capuchon chromé	32 (Pedido mínimo)	14,21 €
 	E0091463	Plaquette 0914/63x30mm Asfour cristal Longueur (mm): 63 Largeur (mm): 30 Couleur: Transparent	98 (Pedido mínimo)	1,18 €

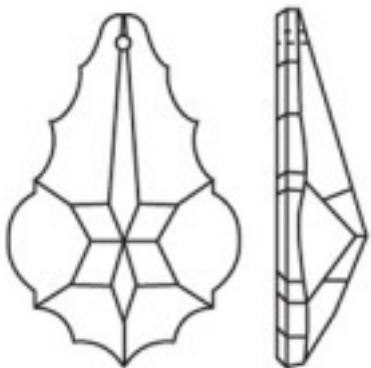

Sous famille **Plaquettes "Asfour"**

Photo	Article	Description	Lot	Prix unitaire
	E0092590	Plaquette 0925 / 100x60mm Asfour crystal	16 (Pedido mínimo)	4,68 €
		Longueur (mm): 100 Largeur (mm): 60 Couleur: Transparent		
				

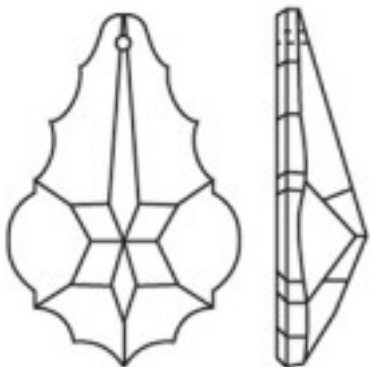

	E0091138	Plaquette 0911/38x26mm Asfour cristal	384 (Pedido mínimo)	0,5093 €
		Longueur (mm): 38 Largeur (mm): 26 Couleur: Transparent		
				

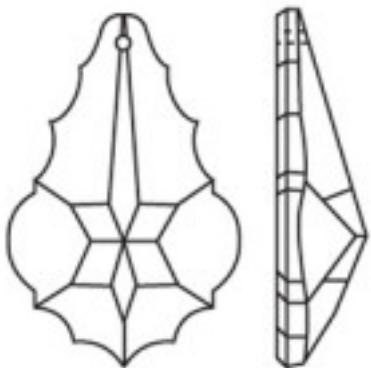

Sous famille **Plaquettes "Asfour"**

Photo	Article	Description	Lot	Prix unitaire
	E0091150		1	1,44 €
	Plaquette 0911/50x35mm Asfour cristal		20	0,96 €
	Longueur (mm): 50 Largeur (mm): 35 Couleur: Transparent		140	0,83 €
				

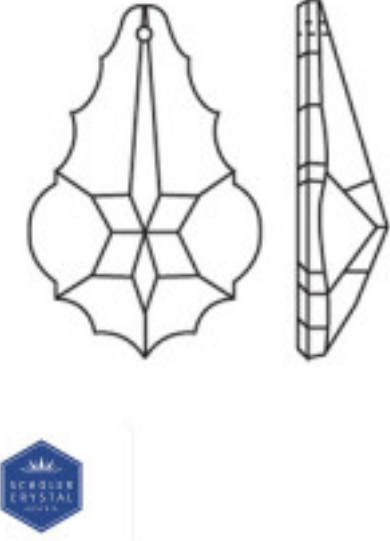
	E0091163		80 (Pedido mínimo)	1,20 €
	Plaquette 091/ 63x43mm Asfour cristal			
	Longueur (mm): 63 Largeur (mm): 44 Couleur: Transparent			
				

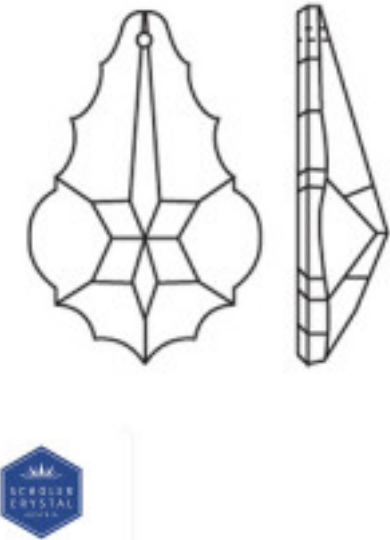
Sous famille **Plaquettes "Asfour"**

Photo	Article	Description	Lot	Prix unitaire
	E0091176		1	3,43 €
	Plaquette 0911/76x53mm Asfour cristal		12	2,29 €
	Longueur (mm): 76 Largeur (mm): 53		48	1,99 €
	Couleur: Transparent			
				

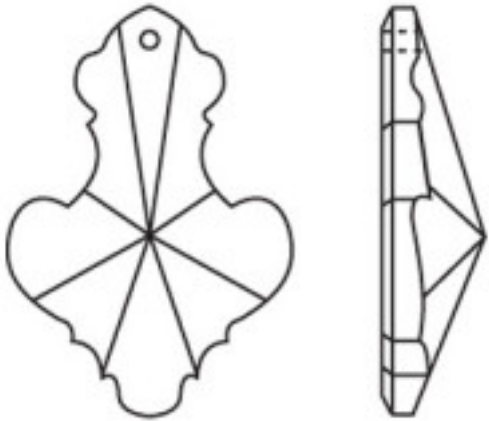

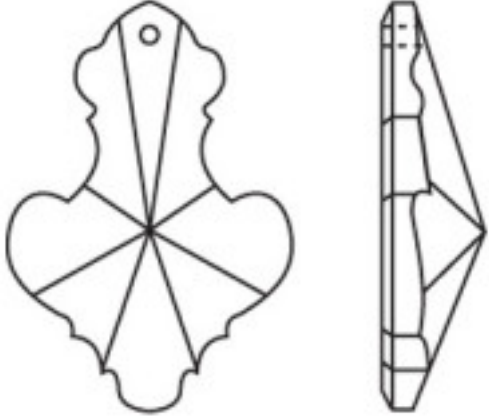

	E0091189		1	4,19 €
	Plaquette 0911/89x61mm Asfour cristal		8	3,34 €
	Longueur (mm): 89 Largeur (mm): 61		32	2,90 €
	Couleur: Transparent			
				

Sous famille **Plaquettes "Asfour"**

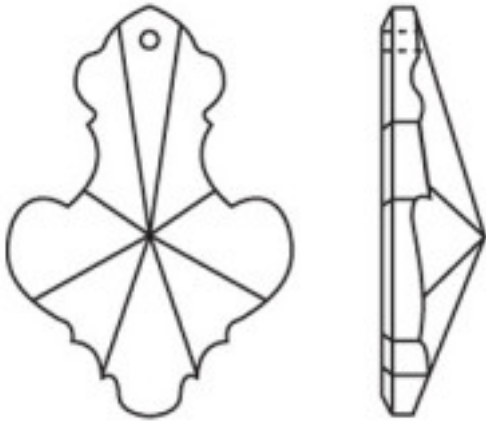

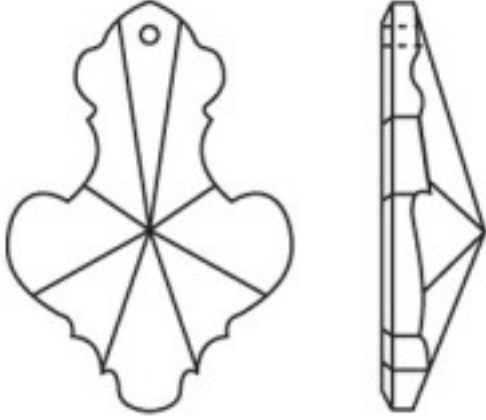

Photo	Article	Description	Lot	Prix unitaire
	E0091191 Plaquette 0911/115x78mm Asfour cristal	Longueur (mm): 115 Largeur (mm): 78 Couleur: Transparent	16 (Pedido mínimo)	5,90 €

	E0091192 Plaquette 0911/125x89mm Asfour cristal	Longueur (mm): 125 Largeur (mm): 89 Couleur: Transparent	9 (Pedido mínimo)	8,94 €
---	--	---	-------------------	--------

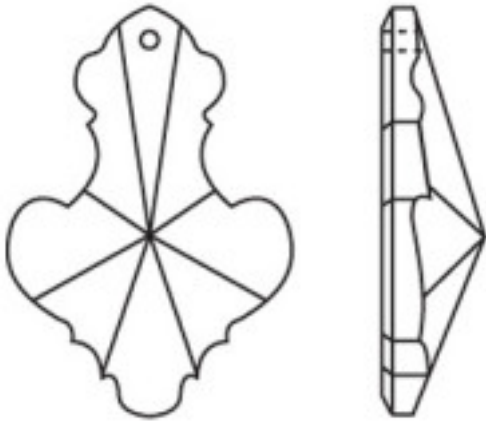

Sous famille **Plaquettes "Asfour"**

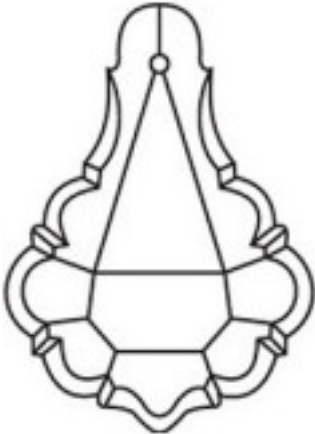

Photo	Article	Description	Lot	Prix unitaire
 	E0091550 Plaquette 0915/50x33mm Asfour cristal	Longueur (mm): 50 Largeur (mm): 33 Couleur: Transparent	168 (Pedido mínimo)	0,71 €
 	E0091563 Plaquette 0915/63x42mm Asfour cristal	Longueur (mm): 63 Largeur (mm): 42 Couleur: Transparent	108 (Pedido mínimo)	1,03 €

Sous famille **Plaquettes "Asfour"**

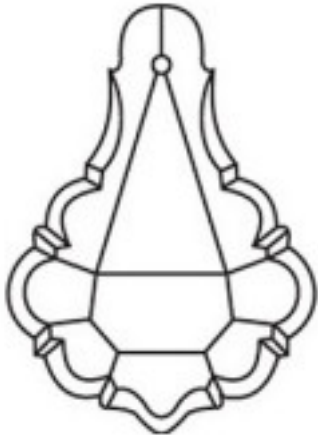
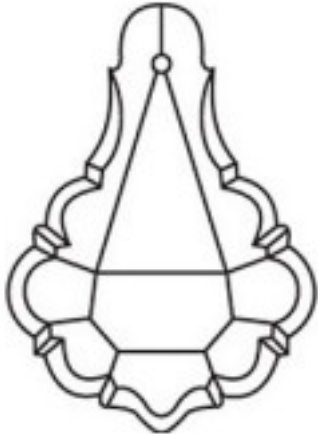
Photo	Article	Description	Lot	Prix unitaire
 	E0091576 Plaquette 0915/76x50mm Asfour cristal	Longueur (mm): 76 Largeur (mm): 50 Couleur: Transparent	60 (Pedido mínimo)	1,44 €
 	E0091589 Plaquette 0915/89x59mm Asfour cristal	Longueur (mm): 89 Largeur (mm): 58 Couleur: Transparent	32 (Pedido mínimo)	2,25 €

Sous famille **Plaquettes "Asfour"**

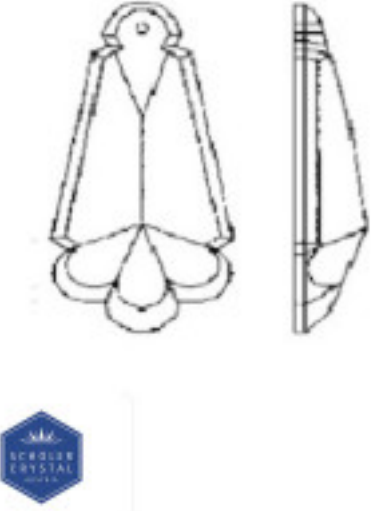
Photo	Article	Description	Lot	Prix unitaire
 	E0091590 Plaquette 0915/100x66mm Asfour cristal	Longueur (mm): 100 Largeur (mm): 66 Couleur: Transparent	30 (Pedido mínimo)	3,37 €

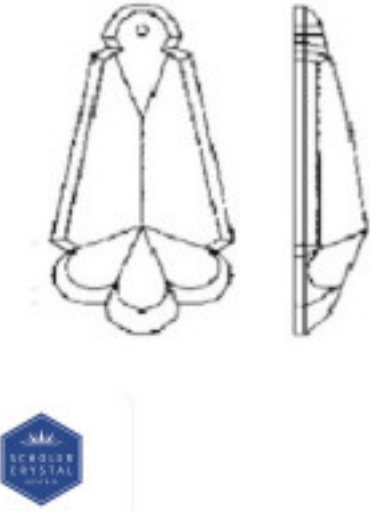
 	E0090263 Plaquette 0902/63x47mm Asfour cristal	Longueur (mm): 63 Largeur (mm): 47 Couleur: Transparent	84 (Pedido mínimo)	1,17 €
---	---	--	--------------------	--------

Sous famille **Plaquettes "Asfour"**

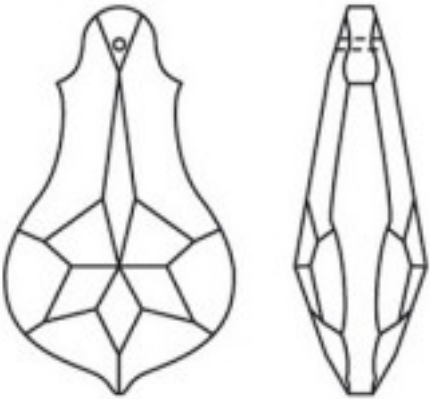

Photo	Article	Description	Lot	Prix unitaire
	E0090289	Plaquette 0902/89x67mm Asfour cristal	42 (Pedido mínimo)	3,25 €
		Longueur (mm): 89 Largeur (mm): 67 Couleur: Transparent		
	E0090290	Plaquette 0902/100x76mm Asfour cristal	24 (Pedido mínimo)	3,42 €
		Longueur (mm): 100 Largeur (mm): 77 Couleur: Transparent		

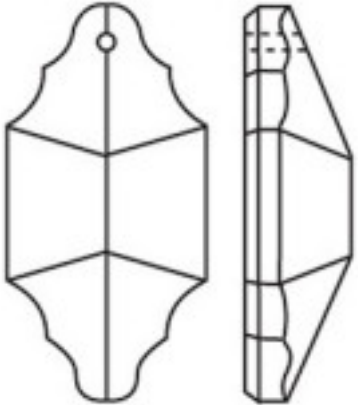

Sous famille **Plaquettes "Asfour"**

Photo	Article	Description	Lot	Prix unitaire
	E0090689 Plaquette 0906/89x40mm Asfour cristal	Longueur (mm): 89 Largeur (mm): 40 Couleur: Transparent	40 (Pedido mínimo)	3,25 €

	E0090690 Plaquette 0906/100x45mm Asfour cristal	Longueur (mm): 100 Largeur (mm): 45 Couleur: Transparent	24 (Pedido mínimo)	3,73 €
---	--	--	--------------------	--------





Sous famille **Plaquettes "Asfour"**

Photo	Article	Description	Lot	Prix unitaire
 	E0087763 Plaquette 0877/63x37mm Asfour cristal	Longueur (mm): 63 Largeur (mm): 37 Couleur: Transparent	80 (Pedido mínimo)	2,67 €

 	E0091363 Plaquette 0913/63x30mm Asfour cristal	Longueur (mm): 63 Largeur (mm): 30 Couleur: Transparent	98 (Pedido mínimo)	1,18 €
--	---	--	--------------------	--------



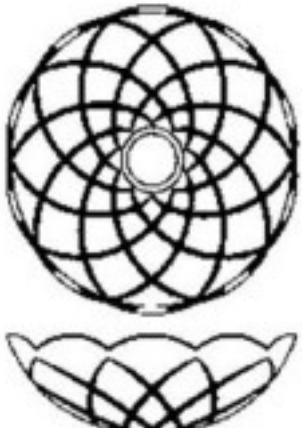

Catalogue **CRISTAL POUR LAMPES**
 Ligne **SCHOLER CRYSTAL AUTRICHIEN**
 Famille **LIGNE SCHÖLER ASFOUR**

Sous famille **Coupelles "Asfour"**



Photo	Article	Description	Lot	Prix unitaire
 	E0010215	Coupelle 102/110mm trou central 10mm - 5 trous latéraux cristal Asfour	8 (Pedido mínimo)	4,13 €
		Hauteur (mm): 40 Diamètre (mm): 110 Couleur: Transparent Trou central (mm): 10 Trous latéraux (mm): 5		
 	E0010310	Coupelle 103/100mm trou central 10mm - 5 trous latéraux cristal Asfour	9 (Pedido mínimo)	3,61 €
		Hauteur (mm): 33 Diamètre (mm): 100 Couleur: Transparent Trou central (mm): 10 Trous latéraux (mm): 5		

CRISTAL POUR LAMPES > SCHOLER CRYSTAL AUTRICHIEN > LIGNE SCHÖLER ASFOUR



Sous famille Coupelles "Asfour"

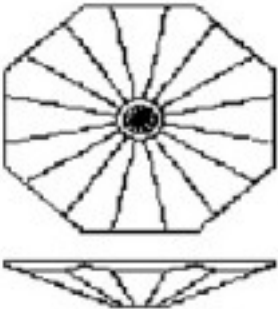

Photo	Article	Description	Lot	Prix unitaire
 	E00103100	Coupelle 0103/100mm trou central 26mm - 5 trous latéraux Asfour	9 (Pedido mínimo)	3,61 €
		Hauteur (mm): 33 Diamètre (mm): 100 Couleur: Transparent Trou central (mm): 26 Trous latéraux (mm): 5		
 	E0010315	Coupelle 0103/150mm trou central 10mm - 5 trous latéraux Asfour	5 (Pedido mínimo)	6,72 €
		Hauteur (mm): 44 Diamètre (mm): 150 Couleur: Transparent Trou central (mm): 10 Trous latéraux (mm): 5		

Sous famille Coupelles "Asfour"

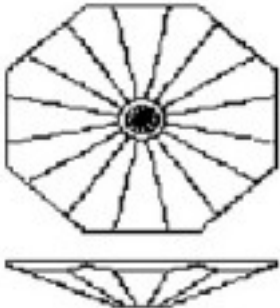

Photo	Article	Description	Lot	Prix unitaire
	E00103200	Coupelle 0103/120mm trou central 26mm - 5 trous latéraux Asfour	9 (Pedido mínimo)	4,65 €
		Hauteur (mm): 38 Diamètre (mm): 120 Couleur: Transparent Trou central (mm): 26 Trous latéraux (mm): 5		
	E0010335	Coupelle 103/350mm trou central 13mm cristal Asfour	1	77,32 €
		Hauteur (mm): 90 Diamètre (mm): 350 Couleur: Transparent Trou central (mm): 10		

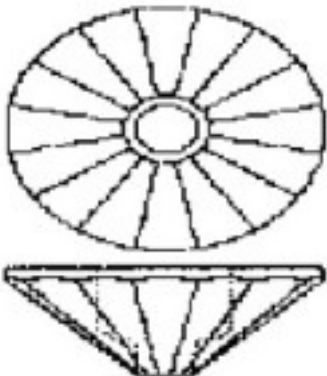

Sous famille Coupelles "Asfour"

Photo	Article	Description	Lot	Prix unitaire
	E0010415	Coupelle 104/150mm trou central 10mm - 5 trous latéraux cristal Asfour	2 (Pedido mínimo)	10,86 €
		Hauteur (mm): 68 Diamètre (mm): 150 Couleur: Transparent Trou central (mm): 10 Trous latéraux (mm): 5		
				

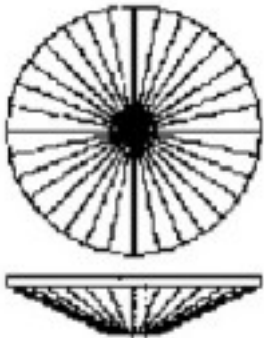
	E0103610	Coupelle 1036/100mm Asfour cristal	9 (Pedido mínimo)	15,26 €
		Diamètre (mm): 100 Couleur: Transparent Trou central (mm): 11		
				

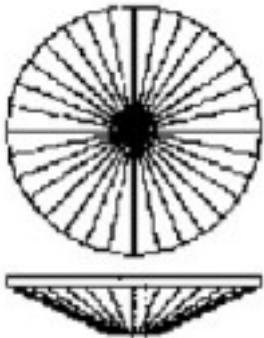
Sous famille Coupelles "Asfour"

Photo	Article	Description	Lot	Prix unitaire
	E0103614	Coupelle 1036/100mm Asfour cristal	9 (Pedido mínimo)	17,43 €
	Avec 4 forets latéraux Diamètre (mm): 100 Couleur: Transparent Trou central (mm): 11 Trous latéraux (mm): 4			
				

	E0103720	Coupelle 1037/100mm Asfour cristal	5 (Pedido mínimo)	26,88 €
	Couleur: Transparent Trou central (mm): 19			
				

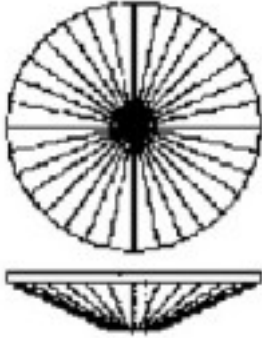
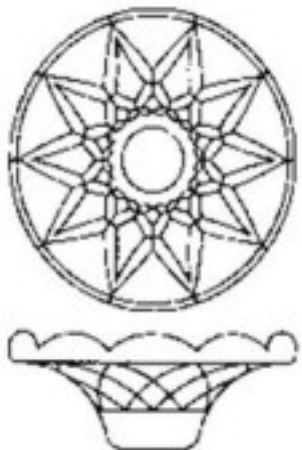
Sous famille Coupelles "Asfour"

Photo	Article	Description	Lot	Prix unitaire
	E0103810	Coupelle 1038/100mm Asfour cristal	9 (Pedido mínimo)	14,48 €
		Couleur: Transparent Trou central (mm): 10		

	E0103814	Coupelle 1038/100mm 4 trous Asfour cristal	9 (Pedido mínimo)	16,67 €
		Couleur: Transparent Trou central (mm): 11 Trous latéraux (mm): 4		

CRISTAL POUR LAMPES > SCHOLER CRYSTAL AUTRICHIEN > LIGNE SCHÖLER ASFOUR

Sous famille Coupelles "Asfour"

Photo	Article	Description	Lot	Prix unitaire
	E0103820	Coupelle 1038/100mm central trou 26mm. Asfour cristal Couleur: Transparent Trou central (mm): 26	9 (Pedido mínimo)	14,48 €
	E11021105A	Rondelle 0102/110mm tc 26mm. 5 trous Diamètre (mm): 110 Couleur: Transparent Trou central (mm): 26 Troux latéraux (mm): 5	8 (Pedido mínimo)	4,13 €

Catalogue **CRISTAL POUR LAMPES**
Ligne **SCHOLER CRYSTAL AUTRICHIEN**
Famille **LIGNE SCHÖLER ASFOUR**
Sous famille **Cristal Rosettes**

Photo	Article	Description	Lot	Prix unitaire
-------	---------	-------------	-----	---------------

Catalogue **CRISTAL POUR LAMPES**
 Ligne **SCHOLER CRYSTAL AUTRICHIEN**
 Famille **LIGNE SCHÖLER ASFOUR**

Sous famille **Nœuds et colonnes**

Photo	Article	Description	Lot	Prix unitaire
	E002040		1	9,31 €
	Enfilage 204/ 170x70mm Asfour cristal Trou central : 16/24/40 mm Hauteur (mm): 170 Diamètre (mm): 70 Couleur: Transparent			
				