

Catalogue **SWAROVSKI CRYSTAL**  
 Ligne **CRISTAL STRASS SWAROVSKI**  
 Famille **PIECES POUR COLLAGE STRASS SWAROVSKI**

Sous famille **Cristal avec revêtement pour collage "Strass" Swarovski**

**REMARQUE IMPORTANTE: Les lignes STRASS et SPECTRA sont hors production. Les articles en stock seront disponibles jusqu'à épuisement des stocks .**

Photo	Article	Description	Lot	Prix unitaire
	110855012		1	4,29 €
	Demi-boule 7120/14mm taille classique CAL'V'SI		112	3,44 €
	Swarovski Crystal		560	2,99 €

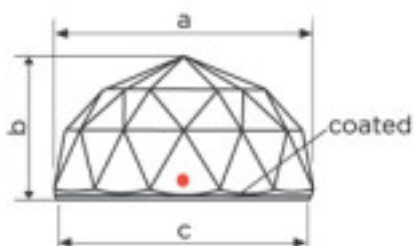

Avec effet CAL"VZ"SI. a=13,9(+/-0,3mm)  
 b=7,5(+/-0,3mm) c=13,3(+/-0,3mm)

Diamètre (mm): 14 Couleur: Transparent

Référence: 1067322



	110855027		1	2,25 €
	Boule 8550/20mm Saphir moyen CAL'VZ'SI		48	2,15 €
	Effet CAL"V"SI pour coller		144	2,09 €

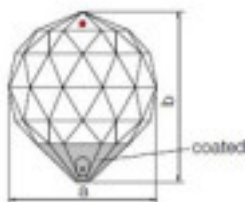

Diamètre (mm): 20 Couleur: Saphir moyen



SWAROVSKI CRYSTAL > CRISTAL STRASS SWAROVSKI > PIECES POUR COLLAGE STRASS SWAROVSKI

Sous famille **Cristal avec revêtement pour collage "Strass" Swarovski**

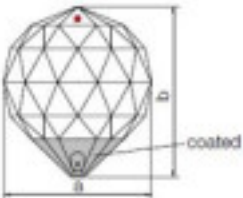
Photo	Article	Description	Lot	Prix unitaire
	110855028		1	3,21 €
	Boule 8550/20mm Vert antique CAL VZ		48	3,07 €
	Effet CALVZ pour coller		144	2,98 €
	Diamètre (mm): 20 Couleur: Vert antique			

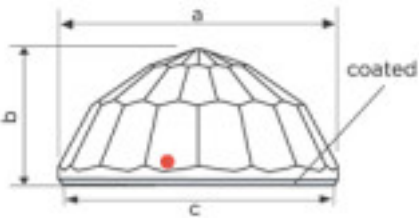

	110855029		1	6,20 €
	Demi-boule 7125/20mm CAL'V'SI Swarovski Crystal		60	4,94 €
	Effet CAL"V"SI pour coller. Dimensions: A=19,9mm (+/-0,4mm) B=9,8mm (+/-0,3mm) C=19,4mm (+/-0,3mm)		300	4,31 €
	Diamètre (mm): 20 Couleur: Transparent			



SWAROVSKI CRYSTAL > CRISTAL STRASS SWAROVSKI > PIECES POUR COLLAGE STRASS SWAROVSKI

Sous famille **Cristal avec revêtement pour collage "Strass" Swarovski**

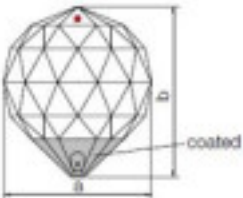
Photo	Article	Description	Lot	Prix unitaire
	11085502V		1	3,49 €
	Boule 8550/20mm VM		48	3,33 €
	Diamètre (mm): 20 Couleur: Effet Vitrail moyen		144	3,23 €

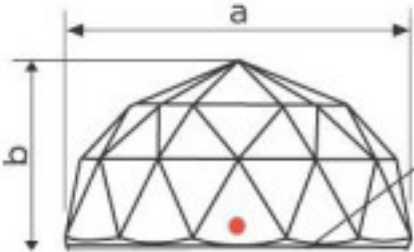

	110855033		1	6,05 €
	Boule 8556/030 002 Swarovski Crystal		24	5,75 €
	Diamètre (mm): 30 Couleur: Transparent		48	5,59 €



SWAROVSKI CRYSTAL > CRISTAL STRASS SWAROVSKI > PIECES POUR COLLAGE STRASS SWAROVSKI

Sous famille **Cristal avec revêtement pour collage "Strass" Swarovski**

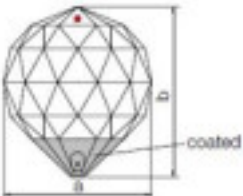
Photo	Article	Description	Lot	Prix unitaire
	11085503V		1	6,63 €
	Boule 8550/30mm VM Swarovski Crystal		24	6,31 €
	Diamètre (mm): 30 Couleur: Effet Vitrail moyen		48	6,13 €

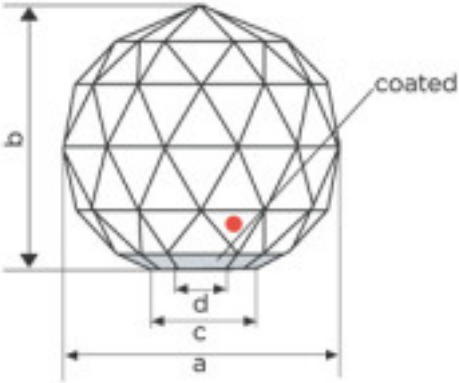

	110855042		1	23,23 €
	Boule 7110/40mm 3/4 CAL'VZ'SI Swarovski Crystal		20	18,57 €
	Effet CAL VZ SI pour coller A=40mm B=35,5mm C=24mm		40	16,16 €
	Diamètre (mm): 40 Couleur: Transparent			

Référence: 1067337



SWAROVSKI CRYSTAL > CRISTAL STRASS SWAROVSKI > PIECES POUR COLLAGE STRASS SWAROVSKI

Sous famille **Cristal avec revêtement pour collage "Strass" Swarovski**

Photo	Article	Description	Lot	Prix unitaire
	110855044		1	16,08 €
	Demi-boule 7120/40mm CAL'V'SI Swarovski Crystal		20	12,85 €
		Effet CAL V SI pour coller. Dimensions: A=42,2(+/-0,3mm) B=20,8(+/-0,3mm) C=40,4(+/-0,3mm)	60	11,18 €

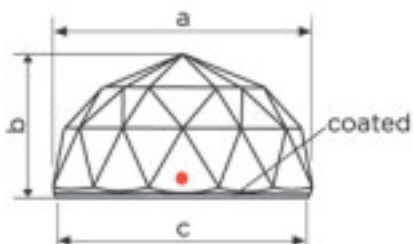

Diamètre (mm): 40 Couleur: Transparent

Référence: 1067338



	110855050		1	17,49 €
	Demi-boule avec trou 7130/50mm CAL'V'SI Swarovski Crystal		12	13,99 €
		Effet CAL V SI. A=49,6mm (+/-0,4mm) B=22,1mm (+/-0,3mm) C=48mm (+/-0,5mm)	24	12,16 €

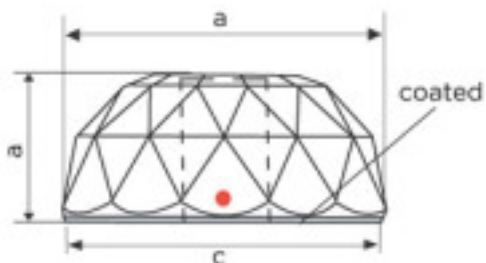

Diamètre (mm): 40 Couleur: Transparent



Trou central (mm): 14



Référence: 1067356

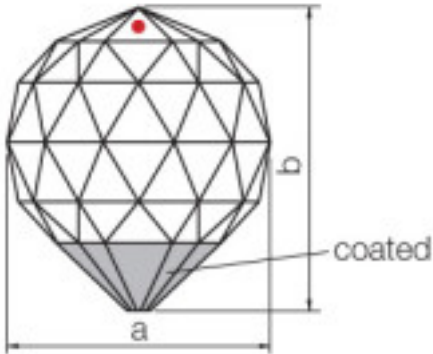

SWAROVSKI CRYSTAL > CRISTAL STRASS SWAROVSKI > PIECES POUR COLLAGE STRASS SWAROVSKI

Sous famille **Cristal avec revêtement pour collage "Strass" Swarovski**

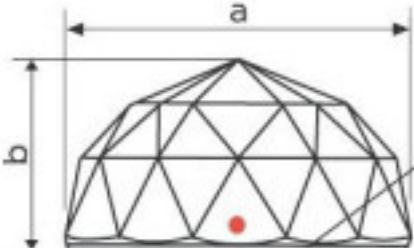
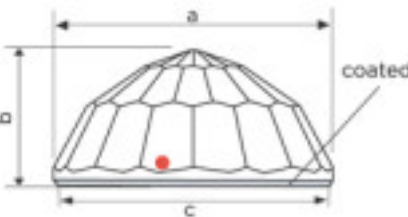

Photo	Article	Description	Lot	Prix unitaire
	110855051		1	34,51 €
	Boule 7100/50mm CAL'VZ'SI Swarovski Crystal		6	27,60 €
	Effet CAL VZ SI pour coller. A=50mm B=55,5mm		12	24,00 €
	Diamètre (mm): 50 Couleur: Transparent			
				

	110855053		1	14,11 €
	Boule 8556/50mm 002 Swarovski Crystal		6	13,43 €
	Sans revêtement		12	13,04 €
	Diamètre (mm): 50 Couleur: Transparent			
				

SWAROVSKI CRYSTAL > CRISTAL STRASS SWAROVSKI > PIECES POUR COLLAGE STRASS SWAROVSKI

Sous famille **Cristal avec revêtement pour collage "Strass" Swarovski**

Photo	Article	Description	Lot	Prix unitaire
	110855054	Demi-boule 7120/50mm taille classique CAL'V'SI Swarovski Crystal	24 (Pedido mínimo)	12,52 €
		Effet CAL V SI pour coller A=49,6mm (+/-0,3mm) B=26,3mm (+/-0,3mm) C=48mm (+/-0,3mm)  Diamètre (mm): 50 Couleur: Transparent  Référence: 1067354		
				

	110855059	Demi boule 7125/50mm Taillecontemporaine. CAL'V'SI strass	1	15,52 €
		Effet CAL V SI pour coller. A=49,8mm (+/-0,4mm); B=23,8mm (+/-0,3mm); C=48,5mm (+/-0,3mm).  Diamètre (mm): 50 Couleur: Transparent		
				

SWAROVSKI CRYSTAL > CRISTAL STRASS SWAROVSKI > PIECES POUR COLLAGE STRASS SWAROVSKI

Sous famille **Cristal avec revêtement pour collage "Strass" Swarovski**

Photo	Article	Description	Lot	Prix unitaire
	1108550Z2		1	7,75 €
	Demi-boule 7120/20mm taille classique Swarovski		60	6,20 €
	Crystal Jet		300	5,39 €

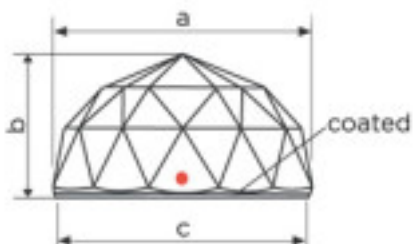

Mesures A=19,6mm (+/-0,3mm) B=10,5mm (+/-0,3mm) C=19mm (+/-0,3mm) couleur Jet

Diamètre (mm): 20 Couleur: Noir

Référence: 1067326



	1108550Z5		1	26,28 €
	Boule 7120/50mm Jet		12	21,01 €
			24	18,28 €

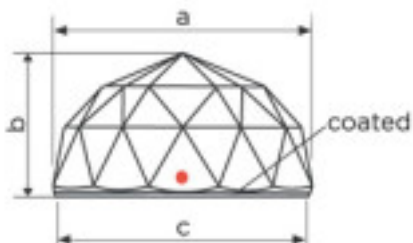

Diamètre (mm): 50 Couleur: Noir





Référence: 1192906









SWAROVSKI CRYSTAL &gt; CRISTAL STRASS SWAROVSKI &gt; PIECES POUR COLLAGE STRASS SWAROVSKI

Sous famille **Cristal avec revêtement pour collage "Strass" Swarovski**

Photo	Article	Description	Lot	Prix unitaire
 	110885022 Pièce 8850/20mm 000 CAL VZ strass	Effet CAL VZ pour coller  Longueur (mm): 20 Largeur (mm): 8 Couleur: Transparent	1	1,81 €
 	110885300 Pièce 8853/008 000 strass	Couleur: Transparent	1	0,0966 €

SWAROVSKI CRYSTAL &gt; CRISTAL STRASS SWAROVSKI &gt; PIECES POUR COLLAGE STRASS SWAROVSKI

Sous famille **Cristal avec revêtement pour collage "Strass" Swarovski**

Photo	Article	Description	Lot	Prix unitaire
 	110885520 Pièce 8855/025 000 strass	Couleur: Transparent	1	0,97 €
 	110885522 Pièce 8855/025 000 CAL VZ strass	Effet CAL VZ pour coller  Longueur (mm): 25 Largeur (mm): 10 Couleur: Transparent	1	2,31 €

SWAROVSKI CRYSTAL &gt; CRISTAL STRASS SWAROVSKI &gt; PIECES POUR COLLAGE STRASS SWAROVSKI

Sous famille **Cristal avec revêtement pour collage "Strass" Swarovski**

Photo	Article	Description	Lot	Prix unitaire
 	110885622 Pièce 8856/025 000 CAL VZ strass	Effet CAL VZ pour coller  Largeur (mm): 10 Hauteur (mm): 25 Couleur: Transparent	1	2,31 €
 	112898822 Piese 8988/020002crystalCAL.VZ	Bouton en verre avec base effet miroir CAL à coller sur capuchon en métal NON inclus  Hauteur (mm): 21 Diamètre (mm): 19,3 Taille: 20 mm Couleur: Crystal Effet de couleur: CAL"VZ"SI	1 144	0,75 € 0,59 €

Catalogue **SWAROVSKI CRYSTAL**  
Ligne **CRISTAL STRASS SWAROVSKI**  
Famille **PIECES POUR COLLAGE STRASS SWAROVSKI**

Sous famille **Cristaux plats "Strass" Swarovski sans revêtement**

**REMARQUE IMPORTANTE: Les lignes STRASS et SPECTRA sont hors production. Les articles en stock seront disponibles jusqu'à épuisement des stocks .**

Photo	Article	Description	Lot	Prix unitaire
	110885310		1	0,1931 €
	Pièce 8853/010 000 strass			
	Couleur: Transparent			
				

	11378310Y		1	1,10 €
	Carré classique 2483/10mm Jet		48	0,88 €
	Dimensions A=10mm (+/-0,3mm) B=3,5mm (+/-0,3mm)		144	0,76 €
	Longueur (mm): 10 Largeur (mm): 10 Couleur: Noir			
Référence: 919934				
				

SWAROVSKI CRYSTAL &gt; CRISTAL STRASS SWAROVSKI &gt; PIECES POUR COLLAGE STRASS SWAROVSKI

## Sous famille Cristaux plats "Strass" Swarovski sans revêtement

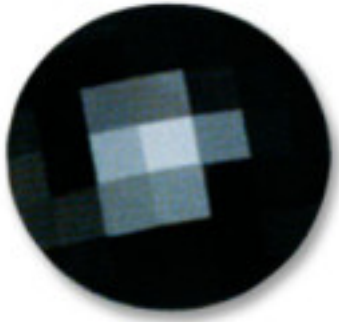
Photo	Article	Description	Lot	Prix unitaire
	11378340Y		1	12,47 €
	Chessboard Circle 2035/40mm Jet Swarovski Crystal		3	9,98 €
	Sans revêtement dimensions A=40mm (+/-0,3mm) B=7,7mm (+/-0,3mm)		6	8,68 €
	Couleur: Noir			



Catalogue **SWAROVSKI CRYSTAL**  
 Ligne **CRISTAL STRASS SWAROVSKI**  
 Famille **PIECES POUR COLLAGE STRASS SWAROVSKI**

Sous famille **Cristaux plats "Strass" Swarovski revêtement en partie plane**

**REMARQUE IMPORTANTE: Les lignes STRASS et SPECTRA sont hors production. Les articles en stock seront disponibles jusqu'à épuisement des stocks .**

Photo	Article	Description	Lot	Prix unitaire
	113783101		1	1,07 €
	Carré classique 2483/10mm bleu Bermudes		48	0,86 €
			144	0,74 €

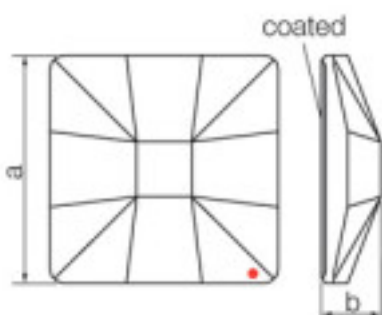

Recouvert en partie plate dimensions A= 10(+/-0.3)  
 B=(+/-0.3)

Longueur (mm): 10 Largeur (mm): 10  
 Couleur: Bleu Bermudes



	113783102		1	0,69 €
	Carré cristal 8083 010 001 Rouge feu		245	0,62 €
			980	0,60 €

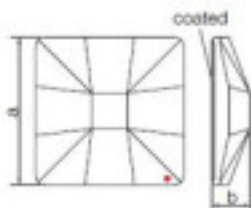



Recouvert en partie plate dimensions A=10(+/-0,3)  
 B=3,5(+/-0,3)



Longueur (mm): 10 Largeur (mm): 10

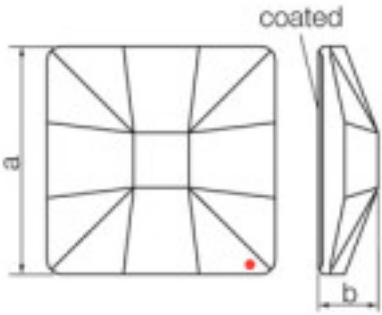

SWAROVSKI CRYSTAL > CRISTAL STRASS SWAROVSKI > PIECES POUR COLLAGE STRASS SWAROVSKI

Sous famille **Cristaux plats "Strass" Swarovski revêtement en partie plane**

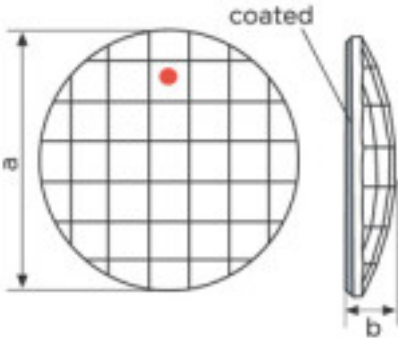
Photo	Article	Description	Lot	Prix unitaire
	113783104		1	1,07 €
	Carré classique 2483/10mm Sahara		48	0,86 €
	Recouvert en partie plate dimensions A=10mm (+/-0,3mm) B=3,5mm (+/-0,3mm)		144	0,74 €
	Longueur (mm): 10 Largeur (mm): 10			
				

	113783201		1	4,93 €
	Echiquier rond 2035/20mm Bleu Bermudes		20	3,95 €
	Effet appliqué en partie plate dimensions A=20mm (+/-0,3mm) B=3,8mm (+/-0,3mm)		40	3,44 €
	Couleur: Bleu Bermudes			
				

SWAROVSKI CRYSTAL > CRISTAL STRASS SWAROVSKI > PIECES POUR COLLAGE STRASS SWAROVSKI

Sous famille **Cristaux plats "Strass" Swarovski revêtement en partie plane**

Photo	Article	Description	Lot	Prix unitaire
	113783204		1	5,53 €
	2035/20mm Sahara		20	4,43 €
	Effet appliqué en partie plate Mesures: A=20mm (+/-0,3mm); B=3,8mm (+/-0,3mm).		40	3,84 €

	113783205		1	5,15 €
	Cercle cristal 8083 020mm 002 Sage		72	4,12 €
	Effet appliqué en partie plate dimensions A=20mm (+/-0,3mm) B=3,8mm (+/-0,3mm)		360	3,58 €
	Longueur (mm): 20			



SWAROVSKI CRYSTAL > CRISTAL STRASS SWAROVSKI > PIECES POUR COLLAGE STRASS SWAROVSKI

Sous famille **Cristaux plats "Strass" Swarovski revêtement en partie plane**

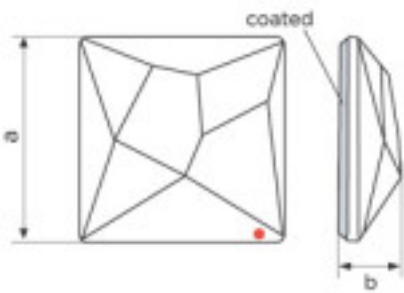
Photo	Article	Description	Lot	Prix unitaire
	113783251A		1	8,61 €
	Asymmetric Square 2420/25mm Bermuda blue		16	6,87 €
	Effet appliqué en partie plate Mesures: A=25mm (+/-0,3mm); B=6,5mm (+/-0,3mm)		32	5,99 €

Couleur: Bleu Bermudes

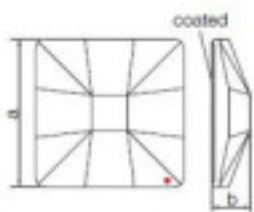

	113783252		1	2,60 €
	Crystal Square 8083 025 001 Blazing Red Swarovski Crystal		32	2,32 €
	Effet appliqué en partie plate dimensions A=25mm (+/-0,3mm) B=6,5mm (+/-0,3mm)		256	2,30 €

Longueur (mm): 25 Largeur (mm): 25



SWAROVSKI CRYSTAL > CRISTAL STRASS SWAROVSKI > PIECES POUR COLLAGE STRASS SWAROVSKI

Sous famille **Cristaux plats "Strass" Swarovski revêtement en partie plane**

Photo	Article	Description	Lot	Prix unitaire
	113783254		1	6,18 €
	Classic Square 2483/25mm Sahara Swarovski Crystal		16	4,95 €
	Effet appliqué en partie plate dimensions A=25mm (+/-0,3mm) B=6,5mm (+/-0,3mm)		32	4,29 €

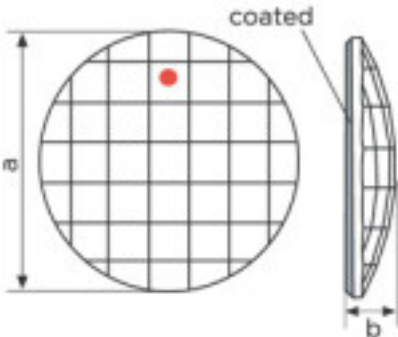

	113783303		1	10,49 €
	Chessboard Circle 2035/30mm CAL'V'SI Swarovski Crystal		6	8,40 €
	Effet appliqué en partie plate dimensions A=30mm (+/-0,3mm) B=6,2mm (+/-0,3mm)		12	7,31 €



SWAROVSKI CRYSTAL > CRISTAL STRASS SWAROVSKI > PIECES POUR COLLAGE STRASS SWAROVSKI

Sous famille **Cristaux plats "Strass" Swarovski revêtement en partie plane**

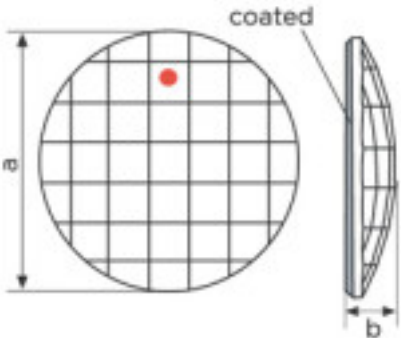
Photo	Article	Description	Lot	Prix unitaire
	113783403		1	21,44 €
	Chessboard Circle 2035/40mm CAL`V`SI Swarovski Crystal		3	17,15 €
			6	14,91 €

Effet appliqué en partie plate dimensions A=40mm (+/-0,3mm) B=7,7mm (+/-0,3mm)

Référence: 1066846

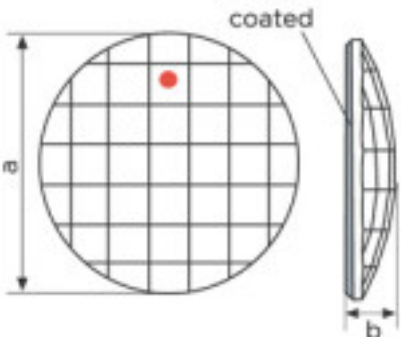

	113783404		1	13,14 €
	Chessboard Circle 2035/40mm Sahara Swarovski Crystal		3	10,51 €
			6	9,15 €



Effet appliqué en partie plate dimensions A=40mm (+/-0,3mm) B=7,7mm (+/-0,3mm)

Référence: 1066854

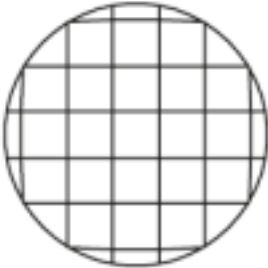

SWAROVSKI CRYSTAL &gt; CRISTAL STRASS SWAROVSKI &gt; PIECES POUR COLLAGE STRASS SWAROVSKI

## Sous famille Cristaux plats "Strass" Swarovski revêtement en partie plane

Photo	Article	Description	Lot	Prix unitaire
 	113783405		1	16,07 €
	Chessboard Circle 2035/40 Sage Swarovski Crystal		3	12,85 €
	Effet appliqué en partie plate dimensions A=40mm (+/-0,3mm) B=7,7mm (+/-0,3mm)		6	11,17 €
	Longueur (mm): 40			
				

Catalogue **SWAROVSKI CRYSTAL**  
Ligne **CRISTAL STRASS SWAROVSKI**  
Famille **PIECES POUR COLLAGE STRASS SWAROVSKI**

Sous famille **Cristaux plats "Strass" Swarovski revêtement sur facettes**

**REMARQUE IMPORTANTE: Les lignes STRASS et SPECTRA sont hors production. Les articles en stock seront disponibles jusqu'à épuisement des stocks .**

Photo	Article	Description	Lot	Prix unitaire
	110885440		1	0,4830 €
	Pièce 8854/014 000 strass			
	Couleur: Transparent			



	113783114		1	1,10 €
	Carré classique 2483/10mm Sahara^V		48	0,88 €
	Effet appliqué en partie à facettes dimensions A=10mm (+/-0,3mm) B=3,5mm (+/-0,3mm)		144	0,76 €

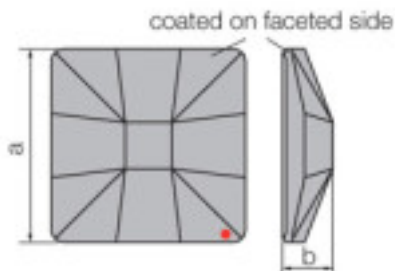

Référence: 1066769



SWAROVSKI CRYSTAL > CRISTAL STRASS SWAROVSKI > PIECES POUR COLLAGE STRASS SWAROVSKI

Sous famille **Cristaux plats "Strass" Swarovski revêtement sur facettes**

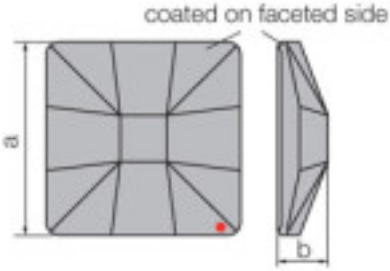
Photo	Article	Description	Lot	Prix unitaire
	113783115		1	0,94 €
		Carré classique 2483/10 cristal Sage 'V'	48	0,75 €
		Mesures: A=10mm (+/-0,3mm); B=3,5mm (+/-0,3mm)	144	0,65 €

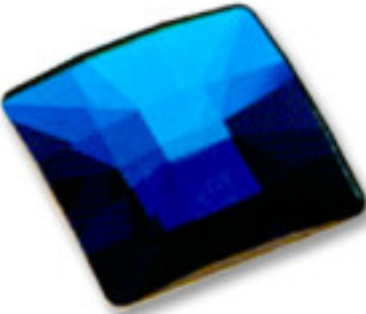

	113783351		1	3,63 €
		Carré classique 2483/25mm bleu Bermudes'V	16	2,91 €
		Effet appliqué en partie à facettes Mesures: A=25mm (+/-0,3mm); B=6,5mm (+/-0,3mm)	32	2,53 €

Couleur: Bleu Bermudes



SWAROVSKI CRYSTAL > CRISTAL STRASS SWAROVSKI > PIECES POUR COLLAGE STRASS SWAROVSKI

Sous famille **Cristaux plats "Strass" Swarovski revêtement sur facettes**

Photo	Article	Description	Lot	Prix unitaire
	113783353		1	7,00 €
	Classic Square 2483/25mm CAL'SI Swarovski		16	5,60 €
	Crystal		32	4,87 €

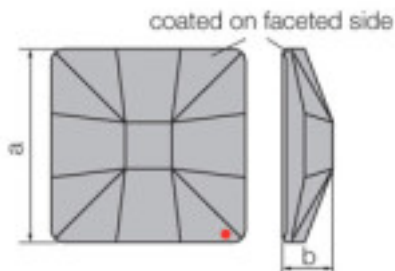

Effet appliqué en partie à facettes dimensions  
A=25mm (+/-0,3mm) B=6,5mm (+/-0,3mm)

Référence: 1066779



	113783354		1	6,79 €
	Classic Square 2483/25mm Sahara V Swarovski		16	5,43 €
	Crystal		32	4,72 €

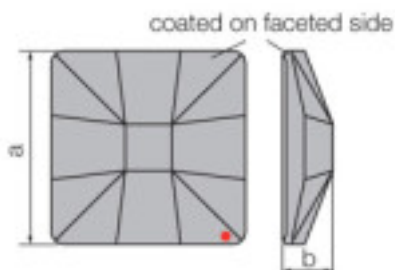



Effet appliqué en partie à facettes dimensions  
A=25mm (+/-0,3mm) B=6,5mm (+/-0,3mm)



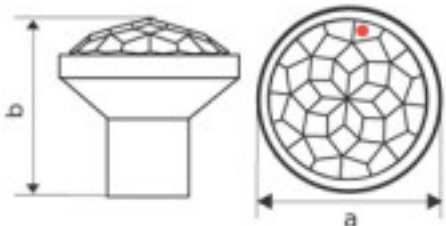

Catalogue **SWAROVSKI CRYSTAL**  
Ligne **CRISTAL STRASS SWAROVSKI**  
Famille **PIECES POUR COLLAGE STRASS SWAROVSKI**

Sous famille **Châtons "Strass" Swarovski**

**REMARQUE IMPORTANTE: Les lignes STRASS et SPECTRA sont hors production. Les articles en stock seront disponibles jusqu'à épuisement des stocks .**

Photo	Article	Description	Lot	Prix unitaire
	113737133		1	62,79 €
	Poignée Chaton 7150/34mm 081 or		3	50,25 €
	Support or dimensions 34mmx33mm A=29,4mm (+/-0,3mm) B=17,5mm (+/-0,3mm)		6	43,68 €
	Référence: 1068464			
				

	113737261		1	52,24 €
	Crystal Rocks Handle 7153/62mm (001AB) 082 Silver Swarovski Crystal			
	Référence: 5236342			
				
				

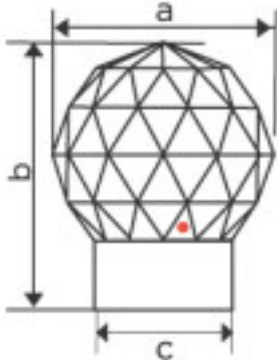

Sous famille Châtons "Strass" Swarovski

Photo	Article	Description	Lot	Prix unitaire
	113737343		1	59,65 €
	Poignée Globe 7156/40mm 081 or		5	47,72 €

Support or. Mesures:40mmx50mm( A=40mm;  
B=50mm; C=25,5mm)

Référence: 1072848



113737351  
Poignée Globe 7157/50mm chromée

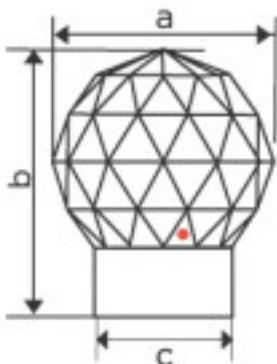

Support chromé Mesures: A=50mm; B=59,5mm;  
C=31,5mm

