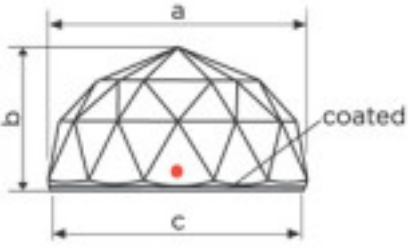


Catalogue **SWAROVSKI CRYSTAL**
Ligne **CRISTAL STRASS SWAROVSKI**
Famille **PIECES POUR COLLAGE STRASS SWAROVSKI**

Sous famille **Cristal avec revêtement pour collage "Strass" Swarovski**

REMARQUE IMPORTANTE: Les lignes STRASS et SPECTRA sont hors production. Les articles en stock seront disponibles jusqu'à épuisement des stocks .

Photo	Article	Description	Lot	Prix unitaire
	110855012		1	4,29 €
	Demi-boule 7120/14mm taille classique CAL'V'SI		112	3,44 €
	Swarovski Crystal		560	2,99 €

Avec effet CAL"VZ"SI. a=13,9(+/-0,3mm)
b=7,5(+/-0,3mm) c=13,3(+/-0,3mm)

Diamètre (mm): 14 Couleur: Transparent

Référence: 1067322



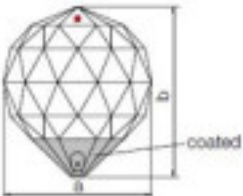
	110855027		1	2,25 €
	Boule 8550/20mm Saphir moyen CAL'VZ'SI		48	2,15 €
	Effet CAL"V"SI pour coller		144	2,09 €

Diamètre (mm): 20 Couleur: Saphir moyen

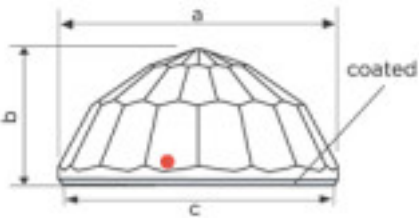


SWAROVSKI CRYSTAL > CRISTAL STRASS SWAROVSKI > PIECES POUR COLLAGE STRASS SWAROVSKI

Sous famille **Cristal avec rev tement pour collage "Strass" Swarovski**

Photo	Article	Description	Lot	Prix unitaire
	110855028		1	3,21 �
	Boule 8550/20mm Vert antique CAL VZ		48	3,07 �
	Effet CALVZ pour coller		144	2,98 �
	Diam�tre (mm): 20 Couleur: Vert antique			

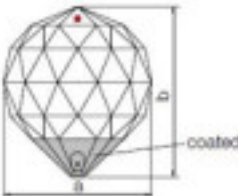


	110855029		1	6,20 �
	Demi-boule 7125/20mm CAL'V'SI Swarovski Crystal		60	4,94 �
	Effet CAL"V"SI pour coller. Dimensions: A=19,9mm (+/-0,4mm) B=9,8mm (+/-0,3mm) C=19,4mm (+/-0,3mm)		300	4,31 �
	Diam�tre (mm): 20 Couleur: Transparent			

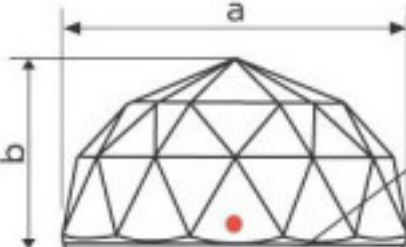


SWAROVSKI CRYSTAL > CRISTAL STRASS SWAROVSKI > PIECES POUR COLLAGE STRASS SWAROVSKI

Sous famille **Cristal avec revêtement pour collage "Strass" Swarovski**

Photo	Article	Description	Lot	Prix unitaire
	11085502V		1	3,49 €
	Boule 8550/20mm VM		48	3,33 €
	Diamètre (mm): 20 Couleur: Effet Vitrail moyen		144	3,23 €

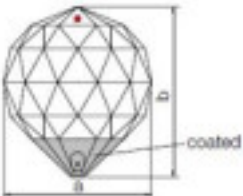


	110855033		1	6,05 €
	Boule 8556/030 002 Swarovski Crystal		24	5,75 €
	Diamètre (mm): 30 Couleur: Transparent		48	5,59 €

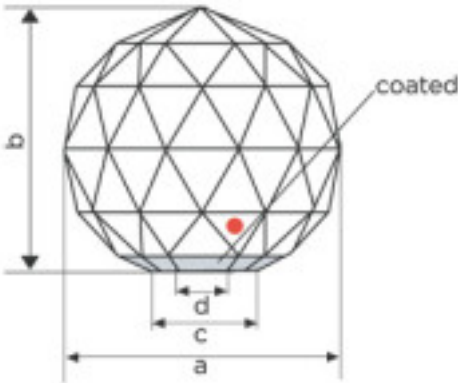


SWAROVSKI CRYSTAL > CRISTAL STRASS SWAROVSKI > PIECES POUR COLLAGE STRASS SWAROVSKI

Sous famille **Cristal avec revêtement pour collage "Strass" Swarovski**

Photo	Article	Description	Lot	Prix unitaire
	11085503V		1	6,63 €
	Boule 8550/30mm VM Swarovski Crystal		24	6,31 €
	Diamètre (mm): 30 Couleur: Effet Vitrail moyen		48	6,13 €



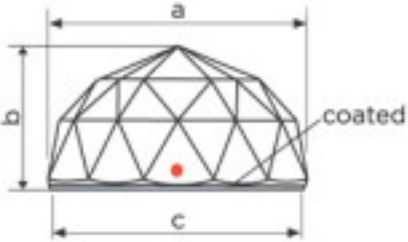

	110855042		1	23,23 €
	Boule 7110/40mm 3/4 CAL'VZ'SI Swarovski Crystal		20	18,57 €
	Effet CAL VZ SI pour coller A=40mm B=35,5mm C=24mm		40	16,16 €
	Diamètre (mm): 40 Couleur: Transparent			

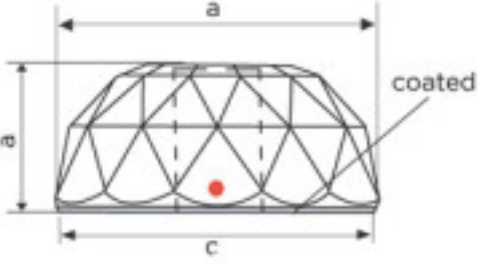

Référence: 1067337



SWAROVSKI CRYSTAL > CRISTAL STRASS SWAROVSKI > PIECES POUR COLLAGE STRASS SWAROVSKI

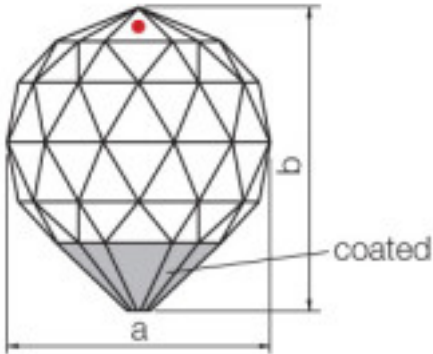

Sous famille **Cristal avec revêtement pour collage "Strass" Swarovski**

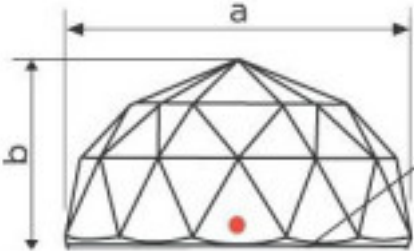

Photo	Article	Description	Lot	Prix unitaire
	110855044		1	16,08 €
	Demi-boule 7120/40mm CAL'V'SI Swarovski Crystal		20	12,85 €
	Effet CAL V SI pour coller. Dimensions: A=42,2(+/-0,3mm) B=20,8(+/-0,3mm) C=40,4(+/-0,3mm)		60	11,18 €
	Diamètre (mm): 40 Couleur: Transparent Référence: 1067338			
				

	110855050		1	17,49 €
	Demi-boule avec trou 7130/50mm CAL'V'SI Swarovski Crystal		12	13,99 €
	Effet CAL V SI. A=49,6mm (+/-0,4mm) B=22,1mm (+/-0,3mm) C=48mm (+/-0,5mm)		24	12,16 €
	Diamètre (mm): 40 Couleur: Transparent Trou central (mm): 14 Référence: 1067356			
				

SWAROVSKI CRYSTAL > CRISTAL STRASS SWAROVSKI > PIECES POUR COLLAGE STRASS SWAROVSKI

Sous famille **Cristal avec revêtement pour collage "Strass" Swarovski**

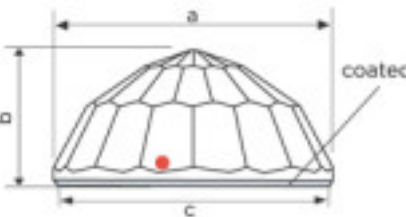

Photo	Article	Description	Lot	Prix unitaire
	110855051		1	34,51 €
	Boule 7100/50mm CAL'VZ'SI Swarovski Crystal		6	27,60 €
	Effet CAL VZ SI pour coller. A=50mm B=55,5mm		12	24,00 €
	Diamètre (mm): 50 Couleur: Transparent			
				

	110855053		1	14,11 €
	Boule 8556/50mm 002 Swarovski Crystal		6	13,43 €
	Sans revêtement		12	13,04 €
	Diamètre (mm): 50 Couleur: Transparent			
				

SWAROVSKI CRYSTAL > CRISTAL STRASS SWAROVSKI > PIECES POUR COLLAGE STRASS SWAROVSKI

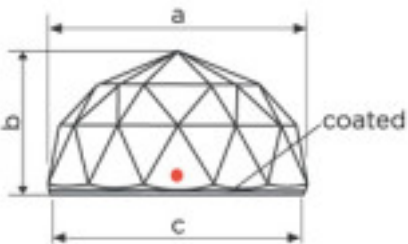
Sous famille **Cristal avec revêtement pour collage "Strass" Swarovski**

Photo	Article	Description	Lot	Prix unitaire
	110855054	Demi-boule 7120/50mm taille classique CAL'V'SI Swarovski Crystal Effet CAL V SI pour coller A=49,6mm (+/-0,3mm) B=26,3mm (+/-0,3mm) C=48mm (+/-0,3mm) Diamètre (mm): 50 Couleur: Transparent Référence: 1067354	24 (Pedido mínimo)	12,52 €
				

	110855059	Demi boule 7125/50mm Taillecontemporaine. CAL'V'SI strass Effet CAL V SI pour coller. A=49,8mm (+/-0,4mm); B=23,8mm (+/-0,3mm); C=48,5mm (+/-0,3mm). Diamètre (mm): 50 Couleur: Transparent	1	15,52 €
				

SWAROVSKI CRYSTAL > CRISTAL STRASS SWAROVSKI > PIECES POUR COLLAGE STRASS SWAROVSKI

Sous famille **Cristal avec revêtement pour collage "Strass" Swarovski**

Photo	Article	Description	Lot	Prix unitaire
	1108550Z2		1	7,75 €
	Demi-boule 7120/20mm taille classique Swarovski		60	6,20 €
	Crystal Jet		300	5,39 €

Mesures A=19,6mm (+/-0,3mm) B=10,5mm (+/-0,3mm) C=19mm (+/-0,3mm) couleur Jet

Diamètre (mm): 20 Couleur: Noir

Référence: 1067326



	1108550Z5		1	26,28 €
	Boule 7120/50mm Jet		12	21,01 €
			24	18,28 €

Diamètre (mm): 50 Couleur: Noir

Référence: 1192906




SWAROVSKI CRYSTAL > CRISTAL STRASS SWAROVSKI > PIECES POUR COLLAGE STRASS SWAROVSKI

Sous famille **Cristal avec revêtement pour collage "Strass" Swarovski**

Photo	Article	Description	Lot	Prix unitaire
 	110885022	Pièce 8850/20mm 000 CAL VZ strass Effet CAL VZ pour coller Longueur (mm): 20 Largeur (mm): 8 Couleur: Transparent	1	1,81 €
 	110885300	Pièce 8853/008 000 strass Couleur: Transparent	1	0,0966 €

SWAROVSKI CRYSTAL > CRISTAL STRASS SWAROVSKI > PIECES POUR COLLAGE STRASS SWAROVSKI

Sous famille Cristal avec revêtement pour collage "Strass" Swarovski

Photo	Article	Description	Lot	Prix unitaire
 	110885520 Pièce 8855/025 000 strass	Couleur: Transparent	1	0,97 €
 	110885522 Pièce 8855/025 000 CAL VZ strass	Effet CAL VZ pour coller Longueur (mm): 25 Largeur (mm): 10 Couleur: Transparent	1	2,31 €

SWAROVSKI CRYSTAL > CRISTAL STRASS SWAROVSKI > PIECES POUR COLLAGE STRASS SWAROVSKI

Sous famille Cristal avec revêtement pour collage "Strass" Swarovski

Photo	Article	Description	Lot	Prix unitaire
 	110885622 Pièce 8856/025 000 CAL VZ strass	Effet CAL VZ pour coller Largeur (mm): 10 Hauteur (mm): 25 Couleur: Transparent	1	2,31 €
 	112898822 Piese 8988/020002crystalCAL.VZ	Bouton en verre avec base effet miroir CAL à coller sur capuchon en métal NON inclus Hauteur (mm): 21 Diamètre (mm): 19,3 Taille: 20 mm Couleur: Crystal Effet de couleur: CAL"VZ"SI	1 144	0,75 € 0,59 €