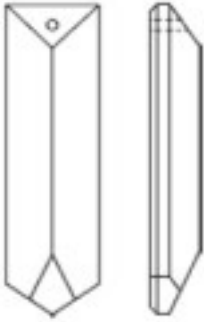

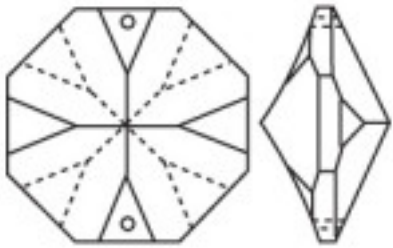



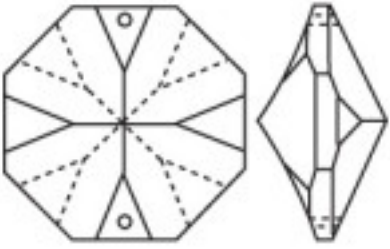

Catalogue **CRISTAL POUR LAMPES**
 Ligne **SCHOLER CRYSTAL AUTRICHIEN**
 Famille **LIGNE SCHÖLER ASFOUR**

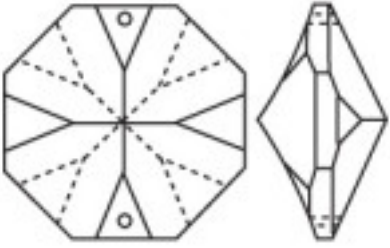

Sous famille **Octogones et carrés "Asfour"**

Photo	Article	Description	Lot	Prix unitaire
	E0050476	Allonge A.0504 76x18mm Asfour cristal	144 (Pedido mínimo)	1,51 €
		Longueur (mm): 76 Largeur (mm): 18 Couleur: Transparent		
				
	E0108014	Octogone 1080/14mm Asfour cristal 2 trous	2000 (Pedido mínimo)	0,0913 €
		Longueur (mm): 14 Couleur: Transparent		
				
				

CRISTAL POUR LAMPES > SCHOLER CRYSTAL AUTRICHIEN > LIGNE SCHÖLER ASFOUR

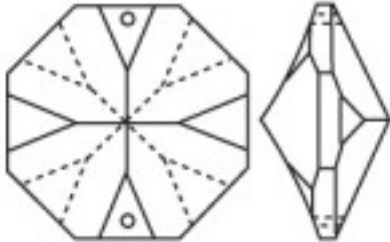
Sous famille **Octogones et carrés "Asfour"**

Photo	Article	Description	Lot	Prix unitaire
	E0108016	Octogone 1080/16mm Asfour cristal 2 trous	1188 (Pedido mínimo)	0,1710 €
	Longueur (mm): 16 Couleur: Transparent			
				

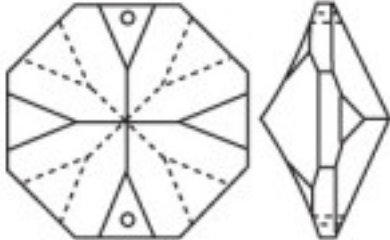
	E0108018	Octogone 1080/18mm Asfour cristal 2 trous	960 (Pedido mínimo)	0,2393 €
	Longueur (mm): 18 Couleur: Transparent			
				

CRISTAL POUR LAMPES > SCHOLER CRYSTAL AUTRICHIEN > LIGNE SCHÖLER ASFOUR

Sous famille **Octogones et carrés "Asfour"**

Photo	Article	Description	Lot	Prix unitaire
	E0108020		1	0,65 €
	Octogone 1080/20mm Asfour cristal 2 trous		65	0,4363 €
	Longueur (mm): 20 Couleur: Transparent		585	0,3790 €

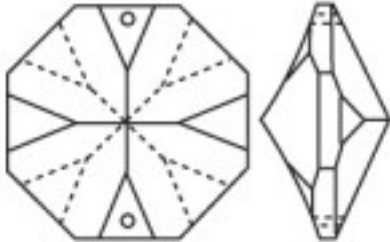


	E0108022		1	0,72 €
	Octogone 1080/22mm Asfour cristal 2 trous		65	0,4791 €
	Longueur (mm): 22 Couleur: Transparent		520	0,4159 €

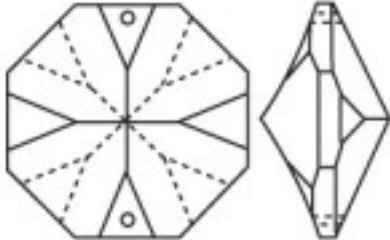


CRISTAL POUR LAMPES > SCHOLER CRYSTAL AUTRICHIEN > LIGNE SCHÖLER ASFOUR

Sous famille **Octogones et carrés "Asfour"**

Photo	Article	Description	Lot	Prix unitaire
	E0108024		1	0,86 €
	Octogone 1080/24mm Asfour cristal 2 trous		46	0,5707 €
	Longueur (mm): 24 Couleur: Transparent		368	0,4957 €

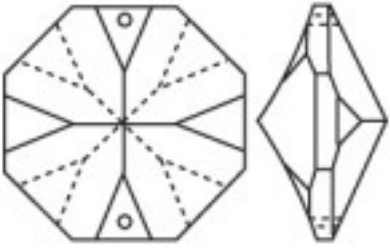



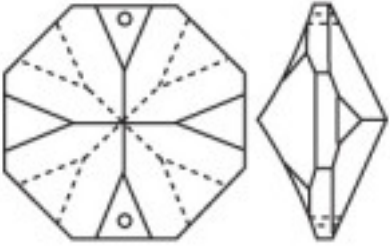

	E0108026		1	1,12 €
	Octogone 1080/26mm Asfour cristal 2 trous		44	0,75 €
	Longueur (mm): 26 Couleur: Transparent		308	0,65 €



CRISTAL POUR LAMPES > SCHOLER CRYSTAL AUTRICHIEN > LIGNE SCHÖLER ASFOUR

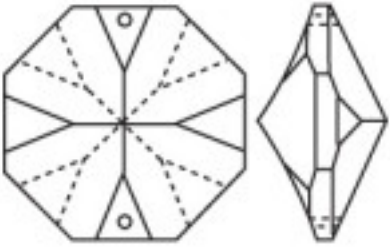

Sous famille **Octogones et carrés "Asfour"**

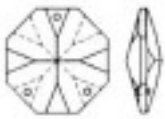

Photo	Article	Description	Lot	Prix unitaire
	E0108028	Octogone 1080/28mm Asfour cristal 2 trous	308 (Pedido mínimo)	0,74 €
	Longueur (mm): 28 Couleur: Transparent			
				

	E0108030	Octogone 1080/30mm Asfour cristal 2 trous	180 (Pedido mínimo)	0,87 €
	Longueur (mm): 30 Couleur: Transparent			
				

CRISTAL POUR LAMPES > SCHOLER CRYSTAL AUTRICHIEN > LIGNE SCHÖLER ASFOUR

Sous famille **Octogones et carrés "Asfour"**

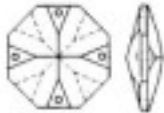
Photo	Article	Description	Lot	Prix unitaire
	E0108032	Octogone 1080/32mm Asfour cristal 2 trous	162 (Pedido mínimo)	1,12 €
	Longueur (mm): 32 Couleur: Transparent			
				

	E0108316	Octogone 1083/16mm Asfour cristal 3 trous	1188 (Pedido mínimo)	0,1710 €
	Longueur (mm): 16 Couleur: Transparent			
				

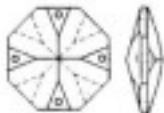
CRISTAL POUR LAMPES > SCHOLER CRYSTAL AUTRICHIEN > LIGNE SCHÖLER ASFOUR

Sous famille **Octogones et carrés "Asfour"**

Photo	Article	Description	Lot	Prix unitaire
	E0108422	Octogone 1084/22mm Asfour cristal 4 trous	520 (Pedido mínimo)	0,4137 €
	Longueur (mm): 22 Couleur: Transparent			

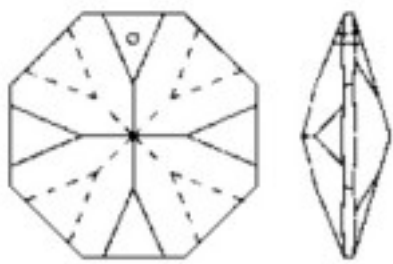



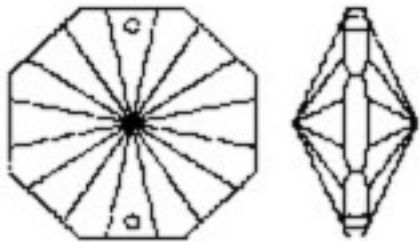

	E0108424	Octogone 1084/24mm Asfour cristal 4 trous	368 (Pedido mínimo)	0,4957 €
	Longueur (mm): 24 Couleur: Transparent			



CRISTAL POUR LAMPES > SCHOLER CRYSTAL AUTRICHIEN > LIGNE SCHÖLER ASFOUR

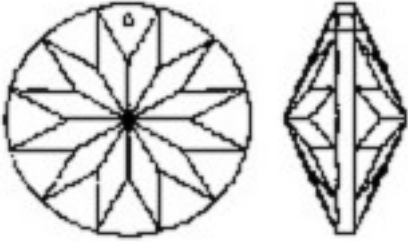
Sous famille **Octogones et carrés "Asfour"**

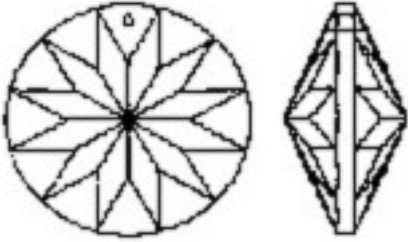
Photo	Article	Description	Lot	Prix unitaire
	E0108114	Octogone 1081/14mm Asfour cristal 1 trou	2000 (Pedido mínimo)	0,0913 €
	Longueur (mm): 14 Couleur: Transparent			
				

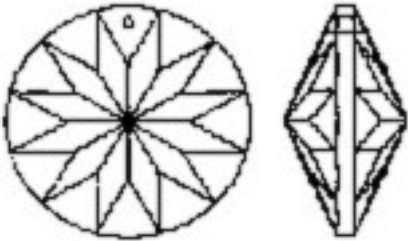
	E0103214	Octogone 1032/14mm Asfour cristal 2 trous	2000 (Pedido mínimo)	0,1368 €
	Longueur (mm): 14 Couleur: Transparent			
				

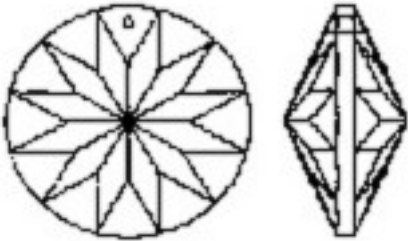
CRISTAL POUR LAMPES > SCHOLER CRYSTAL AUTRICHIEN > LIGNE SCHÖLER ASFOUR

Sous famille **Octogones et carrés "Asfour"**

Photo	Article	Description	Lot	Prix unitaire
	E0104140		1	3,34 €
	Octogone 1041/40mm Asfour cristal 1 trou		17	2,24 €
	Diamètre (mm): 40 Couleur: Transparent		85	1,94 €

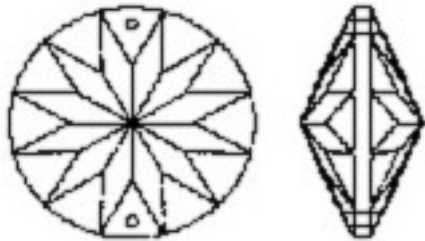



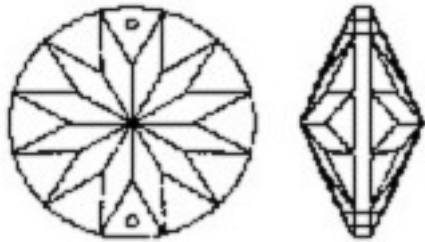

	E0104145		68 (Pedido mínimo)	3,04 €
	Octogone 1041/45mm Asfour cristal 1 trou			
	Diamètre (mm): 45 Couleur: Transparent			



CRISTAL POUR LAMPES > SCHOLER CRYSTAL AUTRICHIEN > LIGNE SCHÖLER ASFOUR

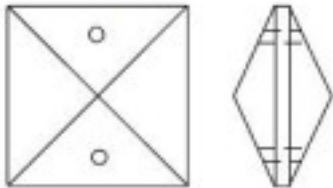

Sous famille **Octogones et carrés "Asfour"**

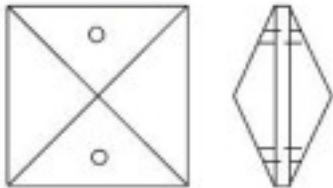

Photo	Article	Description	Lot	Prix unitaire
	E0104040		85 (Pedido mínimo)	1,66 €
	Octogone 1040/40mm Asfour cristal 2 trous	Diamètre (mm): 40 Couleur: Transparent		
				

	E0104045		68 (Pedido mínimo)	2,68 €
	Octogone 1040/45mm Asfour cristal 2 trous	Diamètre (mm): 45 Couleur: Transparent		
				

CRISTAL POUR LAMPES > SCHOLER CRYSTAL AUTRICHIEN > LIGNE SCHÖLER ASFOUR

Sous famille **Octogones et carrés "Asfour"**

Photo	Article	Description	Lot	Prix unitaire
	E0202016	Carré 2020/16mm Asfour cristal 2 trous	1188 (Pedido mínimo)	0,2678 €
	Longueur (mm): 16 Couleur: Transparent			
				

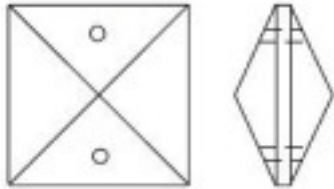
	E0202018	Carré 2020/18mm Asfour cristal 2 trous	960 (Pedido mínimo)	0,3303 €
	Longueur (mm): 18 Couleur: Transparent			
				

CRISTAL POUR LAMPES > SCHOLER CRYSTAL AUTRICHIEN > LIGNE SCHÖLER ASFOUR

Sous famille **Octogones et carrés "Asfour"**

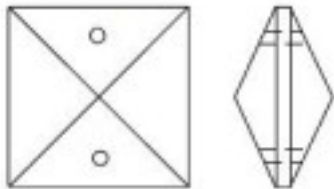
Photo	Article	Description	Lot	Prix unitaire
	E0202020	Carré 2020/20mm Asfour cristal 2 trous	585 (Pedido mínimo)	0,3790 €

Longueur (mm): 20 Couleur: Transparent



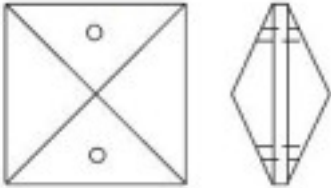

	E0202022	Carré 2020/22mm Asfour cristal 2 trous	520 (Pedido mínimo)	0,4727 €
--	----------	--	---------------------	----------

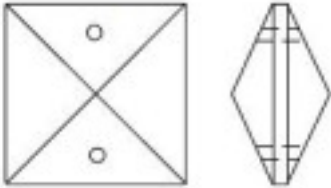

Longueur (mm): 22 Couleur: Transparent



CRISTAL POUR LAMPES > SCHOLER CRYSTAL AUTRICHIEN > LIGNE SCHÖLER ASFOUR

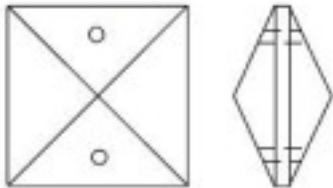

Sous famille **Octogones et carrés "Asfour"**

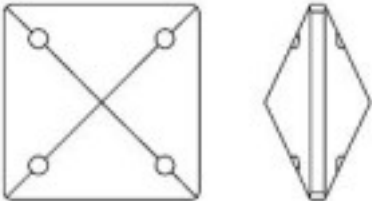

Photo	Article	Description	Lot	Prix unitaire
	E020204	Carré 2020/24mm Asfour cristal 2 trous	308 (Pedido mínimo)	0,61 €
	Longueur (mm): 24 Couleur: Transparent			
				

	E020206	Carré 2020/26mm Asfour cristal 2 trous	308 (Pedido mínimo)	0,71 €
	Longueur (mm): 26 Couleur: Transparent			
				

CRISTAL POUR LAMPES > SCHOLER CRYSTAL AUTRICHIEN > LIGNE SCHÖLER ASFOUR

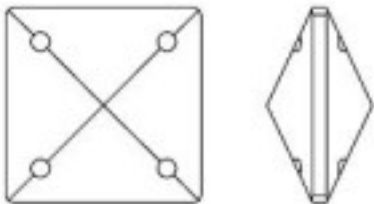

Sous famille **Octogones et carrés "Asfour"**

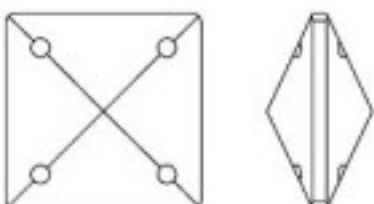
Photo	Article	Description	Lot	Prix unitaire
	E0202028	Carré 2020/28mm Asfour cristal 2 trous	264 (Pedido mínimo)	0,79 €
	Longueur (mm): 28 Couleur: Transparent			
				

	E0202422	Carré 2024/22mm Asfour cristal 4 trous	520 (Pedido mínimo)	0,4727 €
	Longueur (mm): 22 Couleur: Transparent			
				

CRISTAL POUR LAMPES > SCHOLER CRYSTAL AUTRICHIEN > LIGNE SCHÖLER ASFOUR

Sous famille **Octogones et carrés "Asfour"**

Photo	Article	Description	Lot	Prix unitaire
	E0202424	Carré 2024/24mm Asfour cristal 4 trous	308 (Pedido mínimo)	0,61 €
		Longueur (mm): 24 Largeur (mm): 24		
				

	E0202428	Carré 2024/28mm Asfour cristal 4 trous	264 (Pedido mínimo)	0,79 €
		Longueur (mm): 28 Couleur: Transparent		
