







Catalogue **CRISTAL POUR LAMPES**  
 Ligne **SCHOLER CRYSTAL AUTRICHIEN**  
 Famille **LIGNE SCHÖLER LISSE**



Sous famille **Prismes lisses**

Photo	Article	Description	Lot	Prix unitaire
 	A620538		1	0,81 €
	Prisme 4016/38x14mm (ex 3011)		60	0,5346 €
		Longueur (mm): 38 Largeur (mm): 14 Couleur: Transparent	360	0,4662 €
 	A62053A		360 (Pedido mínimo)	1,03 €
	Prisme 4016/38x14mm (ex 3011) améthyste			
		Longueur (mm): 38 Largeur (mm): 14 Couleur: Améthyste		

CRISTAL POUR LAMPES &gt; SCHOLER CRYSTAL AUTRICHIEN &gt; LIGNE SCHÖLER LISSE





Sous famille **Prismes lisses**

Photo	Article	Description	Lot	Prix unitaire
	A62053Q		1	1,77 €
	Prisme 4016/38x14mm (ex 3011) aigue marine		60	1,18 €
	Longueur (mm): 38 Largeur (mm): 14 Couleur: Aigue-marine		360	1,03 €
				

	A62053R		1	1,77 €
	Prisme 4016/38x14mm (ex 3011) rubis		60	1,18 €
	Longueur (mm): 38 Largeur (mm): 14 Couleur: Rubis		360	1,03 €
				





CRISTAL POUR LAMPES &gt; SCHOLER CRYSTAL AUTRICHIEN &gt; LIGNE SCHÖLER LISSE

Sous famille **Prismes lisses**

Photo	Article	Description	Lot	Prix unitaire
 	A62053Z		1	1,77 €
	Prisme 4016/38x14mm (ex 3011) saphir		60	1,18 €
	Longueur (mm): 38 Largeur (mm): 14 Couleur: Saphir		360	1,03 €
 	A620550		180 (Pedido mínimo)	0,86 €
	Prisme 4016/50x15mm (ex 3011)			
	Longueur (mm): 50 Largeur (mm): 15 Couleur: Transparent			





CRISTAL POUR LAMPES &gt; SCHOLER CRYSTAL AUTRICHIEN &gt; LIGNE SCHÖLER LISSE

Sous famille **Prismes lisses**

Photo	Article	Description	Lot	Prix unitaire
 	A62055T		1	2,41 €
	Prisme 4016/50x15mm (ex 3011) cristal ambre		30	1,63 €
	Longueur (mm): 50 Largeur (mm): 15 Couleur: Ambre		180	1,39 €
 	A620563		80 (Pedido mínimo)	1,16 €
	Prisme 4016/63x16mm (ex 3011)			
	Longueur (mm): 63 Largeur (mm): 16 Couleur: Transparent			

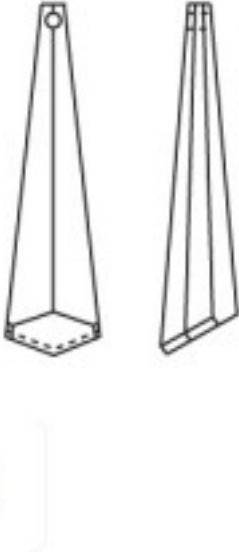
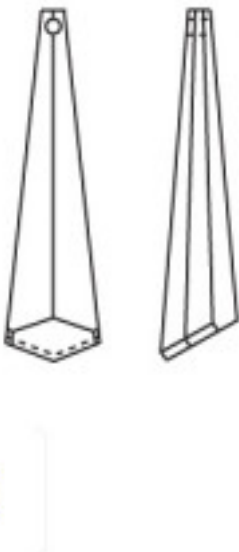
CRISTAL POUR LAMPES &gt; SCHOLER CRYSTAL AUTRICHIEN &gt; LIGNE SCHÖLER LISSE

Sous famille **Prismes lisses**

Photo	Article	Description	Lot	Prix unitaire
 	A62056Y		1	4,38 €
	Prisme 4016/63x16mm (ex 3011) noir		16	2,94 €
	Longueur (mm): 63 Largeur (mm): 16 Couleur: Noir		80	2,54 €
 	A620576		70 (Pedido mínimo)	1,70 €
	Prisme 4016/76x18mm (ex 3011)			
	Longueur (mm): 76 Largeur (mm): 17 Couleur: Transparent			

CRISTAL POUR LAMPES &gt; SCHOLER CRYSTAL AUTRICHIEN &gt; LIGNE SCHÖLER LISSE

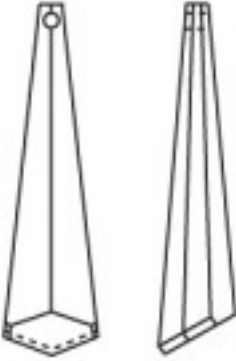

Sous famille **Prismes lisses**

Photo	Article	Description	Lot	Prix unitaire
	A622563	Prisme 4031/63x16mm (ex 3051)	128 (Pedido mínimo)	1,16 €
		Longueur (mm): 63 Largeur (mm): 16 Couleur: Transparent		
	A62256R	Prisme 4031/63x16mm (ex 3051) rubis	1 16 128	4,37 € 2,94 € 2,54 €
		Longueur (mm): 63 Largeur (mm): 16 Couleur: Rubis		

CRISTAL POUR LAMPES &gt; SCHOLER CRYSTAL AUTRICHIEN &gt; LIGNE SCHÖLER LISSE





Sous famille **Prismes lisses**

Photo	Article	Description	Lot	Prix unitaire
	A62256T		1	3,54 €
	Prisme 4031/63x16mm (ex 3051) cristal ambre		16	2,37 €
	Longueur (mm): 63 Largeur (mm): 16 Couleur: Ambre		128	2,05 €
				

	A62256Z		1	4,37 €
	Prisme 4031/63x16mm (ex 3051) saphir		16	2,94 €
	Longueur (mm): 63 Largeur (mm): 16 Couleur: Saphir		128	2,54 €
				

CRISTAL POUR LAMPES &gt; SCHOLER CRYSTAL AUTRICHIEN &gt; LIGNE SCHÖLER LISSE





Sous famille **Prismes lisses**

Photo	Article	Description	Lot	Prix unitaire
	A62353T		1	2,02 €
	Prisme 4130/38x10mm (ex 3031) cristal ambre		60	1,31 €
	Longueur (mm): 38 Largeur (mm): 10 Couleur: Ambre		420	1,16 €
				
	A623550		1	0,98 €
	Prisme 4130/50x11mm (ex 3031)			
	Longueur (mm): 50 Largeur (mm): 11 Couleur: Transparent			
				







CRISTAL POUR LAMPES &gt; SCHOLER CRYSTAL AUTRICHIEN &gt; LIGNE SCHÖLER LISSE

Sous famille **Prismes lisses**

Photo	Article	Description	Lot	Prix unitaire
	A62355L		1	3,41 €
	Prisme 4130/50x11mm (ex 3031) ambre clair		60	2,28 €
	Longueur (mm): 50 Largeur (mm): 11 Couleur: Ambre léger		420	1,94 €
				
	A62355Q		1	3,71 €
	Prisme 4130/50x11mm (ex 3031) aigue marine		60	2,48 €
	Longueur (mm): 50 Largeur (mm): 11 Couleur: Aigue-marine		420	2,15 €
				





CRISTAL POUR LAMPES &gt; SCHOLER CRYSTAL AUTRICHIEN &gt; LIGNE SCHÖLER LISSE

## Sous famille Prismes lisses

Photo	Article	Description	Lot	Prix unitaire
	A62355R		1	3,71 €
	Prisme 4130/50x11mm (ex 3031) rubis		60	2,48 €
	Longueur (mm): 50 Largeur (mm): 11 Couleur: Rubis		420	2,15 €
				
	A62355V		1	3,41 €
	Prisme 4130/50x11mm (ex 3031) Peridot		60	2,28 €
	Longueur (mm): 50 Largeur (mm): 11 Couleur: Peridot léger		420	1,94 €
				





CRISTAL POUR LAMPES &gt; SCHOLER CRYSTAL AUTRICHIEN &gt; LIGNE SCHÖLER LISSE

Sous famille **Prismes lisses**

Photo	Article	Description	Lot	Prix unitaire
	A62355Z		1	3,71 €
	Prisme 4130/50x11mm (ex 3031) saphir		60	2,48 €
	Longueur (mm): 50 Largeur (mm): 11 Couleur: Saphir		420	2,15 €
				
	A623563		256 (Pedido mínimo)	1,21 €
	Prisme 4130/63x12mm (ex 3031)			
	Longueur (mm): 63 Largeur (mm): 12 Couleur: Transparent			
				



CRISTAL POUR LAMPES &gt; SCHOLER CRYSTAL AUTRICHIEN &gt; LIGNE SCHÖLER LISSE

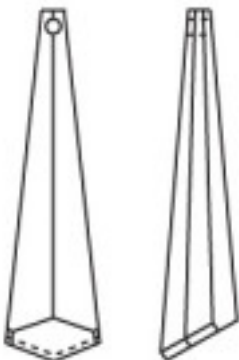

## Sous famille Prismes lisses

Photo	Article	Description	Lot	Prix unitaire
 	A62356T	Prisme 4130/63x12mm (ex 3031) cristal ambre	256 (Pedido mínimo)	1,89 €
		Longueur (mm): 63 Largeur (mm): 12 Couleur: Ambre		
 	A623576	Prisme 4130/76x13mm (ex 3031)	196 (Pedido mínimo)	1,77 €
		Longueur (mm): 76 Largeur (mm): 13 Couleur: Transparent		

CRISTAL POUR LAMPES &gt; SCHOLER CRYSTAL AUTRICHIEN &gt; LIGNE SCHÖLER LISSE

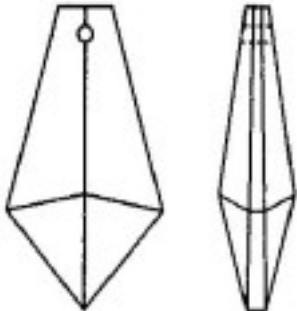

Sous famille **Prismes lisses**

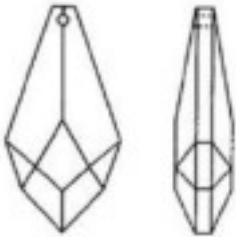

Photo	Article	Description	Lot	Prix unitaire
	A623589		1	4,06 €
	Prisme 4130/89x13mm (ex 3031)		20	2,74 €
	Longueur (mm): 89 Largeur (mm): 13		100	2,38 €
	Couleur: Transparent			
				

	D90316S		1	4,37 €
	Prisme 4031 63x16mm fumé		32	2,94 €
	Longueur (mm): 63 Largeur (mm): 16		128	2,54 €
				

CRISTAL POUR LAMPES > SCHOLER CRYSTAL AUTRICHIEN > LIGNE SCHÖLER LISSE

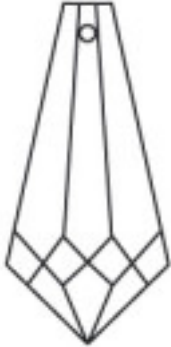

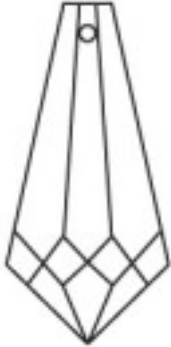

Sous famille **Prismes lisses**

Photo	Article	Description	Lot	Prix unitaire
	D912438		1	1,35 €
	Prisme 4124 38x20mm		120	0,91 €
	Longueur (mm): 38 Largeur (mm): 20 Couleur: Transparent		240	0,79 €
				

	D913150		1	1,90 €
	Prisme 4131 50x25mm cristal		30	1,25 €
	Longueur (mm): 50 Largeur (mm): 25		90	1,09 €
				

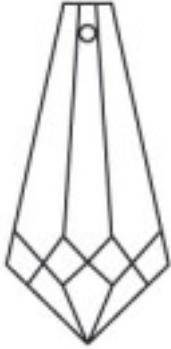

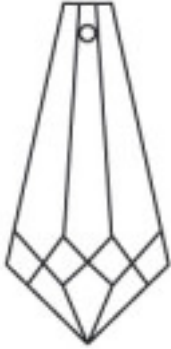

CRISTAL POUR LAMPES &gt; SCHOLER CRYSTAL AUTRICHIEN &gt; LIGNE SCHÖLER LISSE

Sous famille **Prismes lisses**

Photo	Article	Description	Lot	Prix unitaire
	D944038		1	1,73 €
	Prisme 4230/38x18mm		60	1,14 €
	Longueur (mm): 38 Largeur (mm): 18 Couleur: Transparent		300	1,00 €
				
	D94403P		1	3,16 €
	Prisme 4230/38x18mm rosé		60	2,54 €
	Longueur (mm): 38 Largeur (mm): 18 Couleur: Rosé		300	2,20 €
				

CRISTAL POUR LAMPES &gt; SCHOLER CRYSTAL AUTRICHIEN &gt; LIGNE SCHÖLER LISSE

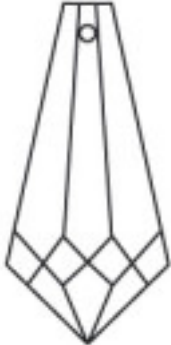

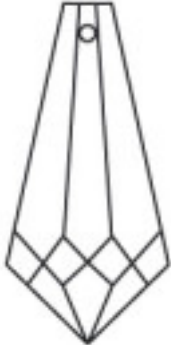

Sous famille **Prismes lisses**

Photo	Article	Description	Lot	Prix unitaire
 	D944050 Prisme 4230/50x20mm	Longueur (mm): 50 Largeur (mm): 20 Couleur: Transparent	150 (Pedido mínimo)	1,31 €
 	D944063 Prisme 4230/63x22mm	Longueur (mm): 63 Largeur (mm): 22 Couleur: Transparent	1 16 64	3,17 € 2,12 € 1,85 €



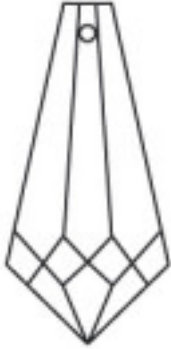

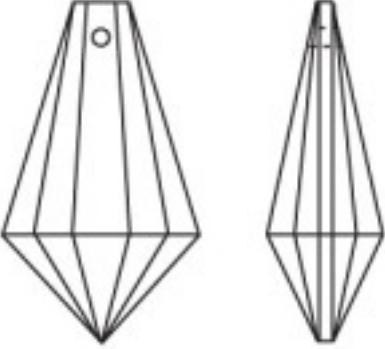

CRISTAL POUR LAMPES > SCHOLER CRYSTAL AUTRICHIEN > LIGNE SCHÖLER LISSE

Sous famille **Prismes lisses**

Photo	Article	Description	Lot	Prix unitaire
 	D944076 Prisme 4230/76x24mm	Longueur (mm): 76 Largeur (mm): 24 Couleur: Transparent	56 (Pedido mínimo)	2,65 €
 	D944089 Prisme 4230/89x26mm	Longueur (mm): 89 Largeur (mm): 26 Couleur: Transparent	1 8 40	6,38 € 4,23 € 3,71 €

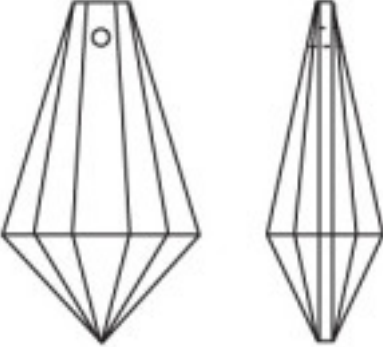

CRISTAL POUR LAMPES &gt; SCHOLER CRYSTAL AUTRICHIEN &gt; LIGNE SCHÖLER LISSE

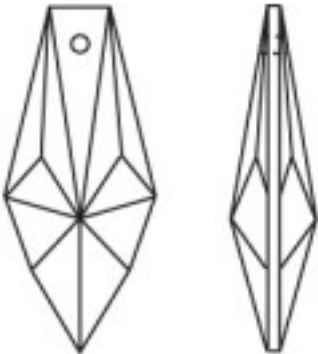

Sous famille **Prismes lisses**

Photo	Article	Description	Lot	Prix unitaire
	D944090 Prisme 4230/100x28mm	Longueur (mm): 100 Largeur (mm): 28 Couleur: Transparent	40 (Pedido mínimo)	5,30 €
				
	A611250 Prisme 1121/50x29mm (ex 1121)	Longueur (mm): 50 Largeur (mm): 25 Couleur: Transparent	1	1,21 €
				

CRISTAL POUR LAMPES &gt; SCHOLER CRYSTAL AUTRICHIEN &gt; LIGNE SCHÖLER LISSE

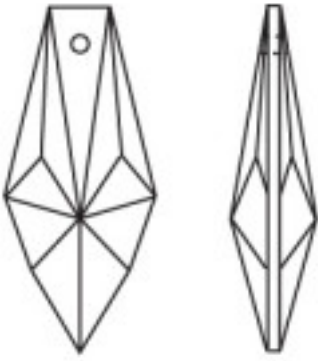

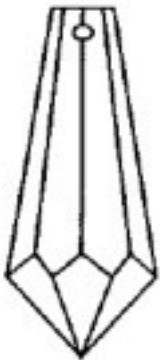

Sous famille **Prismes lisses**

Photo	Article	Description	Lot	Prix unitaire
	A611263		1	3,12 €
	Prisme 1121/63x32mm (ex 1121)		12	2,08 €
	Longueur (mm): 63 Largeur (mm): 32 Couleur: Transparent		60	1,81 €
				

	A620465			
	Prisme 4137/63x25mm (ex 1131)			
	Longueur (mm): 63 Largeur (mm): 25 Couleur: Transparent			
				

CRISTAL POUR LAMPES &gt; SCHOLER CRYSTAL AUTRICHIEN &gt; LIGNE SCHÖLER LISSE

Sous famille **Prismes lisses**

Photo	Article	Description	Lot	Prix unitaire
	A620475	Prisme 4137/76x30mm (ex 1131)	80 (Pedido mínimo)	2,22 €
		Longueur (mm): 76 Largeur (mm): 30 Couleur: Transparent		
				
	A621550	Prisme 4216 /50x18mm (ex 3021)	1 30 150	1,73 € 1,14 € 1,00 €
		Longueur (mm): 50 Largeur (mm): 20 Couleur: Transparent		
				

CRISTAL POUR LAMPES &gt; SCHOLER CRYSTAL AUTRICHIEN &gt; LIGNE SCHÖLER LISSE

Sous famille **Prismes lisses**

Photo	Article	Description	Lot	Prix unitaire
	A621565	Prisme 4216/63x20mm (ex 3021)	80 (Pedido mínimo)	1,52 €
		Longueur (mm): 63 Largeur (mm): 20 Couleur: Transparent		