

Technical Datasheet

EDC F3 Series

Flicker Free
Low SVM

EDC_38C_4W_XXX_XXXV_F302

- Compatible with most TRIAC dimmers
- High Power Factor (>0.95)
- Low THD (<30%)
- Zhaga Standard Mounting Holes
- 60mA Inrush current
- No photo-biological hazard (RG1)
- Uniform Full Dimming
- Percent Flicker (<5%)
- Low SVM (<0.1)
- Low PstLM (<0.4)

EggDrop®

LUMENS

LUMES CO., LTD.

15th floor building B, Giheung ICT Valley.

58 Giheung-gu, Yongin-si, Gyeonggi-do, Korea. (Zip code 16976)

www.lumensleds.com

1. Product Description

* Description

- The EDC (Egg Drop COB) series module is designed for the high power operation to get the high flux output applications.
- It incorporates the state of the art SMD LEDs with high reliability and semiconductor AC direct drive ICs.
- It is ideal for the indoor or down light applications.

* Features

- High performance, High brightness
- No emission of harmful short wavelength light (No UV radiation)
- High power conversion efficiency (>0.85)
- High power factor (>0.95)
- Displacement power factor (>0.98)
- Low THD (< 30%)
- Low EMI
- RoHS compliant
- No photo-biological hazard (RG1)
- Starting current 44 [mA] @ 60ms
- Percent Flicker (<5%)
- SVM (<0.1)
- PstLM (<0.4)

* Applications

- Down Light (Indoor Lighting)
- Spot Light

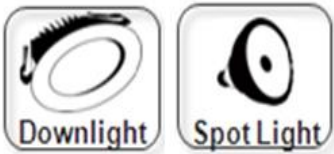

2. Absolute Maximum Ratings

Parameters	Symbol	Min Value	Max Value	Unit
Maximum power dissipation	Pd	-	4.4	W
Maximum operation voltage	Vop	-	250	V
Operating temperature	Top	-40	+85	°C
Storage temperature	Tst	-40	+100	°C

3. Product Name Method

(ex. EggDrop)

Product Family	PCB Size/shape		Power	CRI+CCT		Input Voltage	Management Code				Version
EDC	57	C	XXW	X	XX	XXXV	F	2	0	1	V0_1
'EDC'=EggDrop	Ø33	'C'=Circular	10W	'7'=70 ↑	'27'=2700K	'120V'=120Vac					
'DLM'=DownLight	Ø38	'R'=Rectangular	15W	'8'=80 ↑	'30'=3000K	'220V'=220Vac					
	Ø47	'D'=Donut	ETC.	'9'=90 ↑	'35'=3500K	'230V'=230Vac					
	Ø57	ETC.			'40'=4000K	ETC.					
	Ø80				'50'=5000K						
'LNM'=Linear Bar	280X20				'57'=5700K						
	560X20										

1) Additional explanation

Product Section		Product Description (Product _ PCB Size _ Watt _ CRI+CCT _ Input voltage _ Management code)
EggDrop	EDC	EDC_XXC_XXW_XXX_XXXV_F302_VX_X
DownLight	DLM	DLM_XXC_XXW_XXX_XXXV_F201_VX_X
Linear Bar	LNM	LNM_XXXx20_XXW_XXX_XXXV_C101_VX_X

4. Electro-optical Characteristics (Ta=25°C & 55°C)

Parameters	Symbol	Ta = 25°C			Ta = 55°C			Unit	Condition
		Min.	Typ.	Max.	Min.	Typ.	Max.		
Luminous Flux	Φ_v	390	415	-	380	400	-	lm	2700K, CRI80
		400	425	-	385	410	-		3000K, CRI80
		410	430	-	390	415	-		3500K, CRI80
		415	440	-	400	425	-		4000K, CRI80
		425	450	-	410	435	-		5000K, CRI80
		420	445	-	405	430	-		5700K, CRI80
		345	365	-	330	350	-		2700K, CRI90
		350	370	-	340	360	-		3000K, CRI90
		355	380	-	345	370	-		3500K, CRI90
		360	395	-	350	375	-		4000K, CRI90
		370	400	-	360	385	-		5000K, CRI90
Efficiency	lm/W	98	104	-	95	100	-	lm/W	2700K, CRI80
		100	106	-	96	102	-		3000K, CRI80
		102	108	-	98	104	-		3500K, CRI80
		104	111	-	100	107	-		4000K, CRI80
		106	113	-	102	109	-		5000K, CRI80
		105	112	-	101	108	-		5700K, CRI80
		86	91	-	83	88	-		2700K, CRI90
		88	93	-	85	90	-		3000K, CRI90
		89	95	-	86	92	-		3500K, CRI90
		91	97	-	88	94	-		4000K, CRI90
		93	99	-	90	96	-		5000K, CRI90

(1) At 220~230Vac, T_c = 25°C & 55°C

(2) Φ_v is the total luminous flux output measured with an integrated sphere.

- Measurement accuracy: CRI (±3), Φ_v (±3%), Vf (±3.0V)

Viewing Angle FWHM	2θ1/2	110	120	130	deg	Vop=220~230Vac
Operating Voltage	Vop	220 ~ 230			Vac	
Power Dissipation	Pd	3.6	4.0	4.4	W	Vop=220~230Vac
Rated Current	Ira	17	19	-	mA	Pd=4W
Operating Frequency	Fop	50 / 60			Hz	Vop=220~230Vac
Power Factor	PF	Over 0.95			V	Vop=220~230Vac
Current THD	A-THD	Less than 30%				Vop=220~230Vac
Percent Flicker	%	Less than 5%				Vop=220~230Vac
SVM		Less than 0.1				Vop=220~230Vac
PstLM		Less than 0.4				Vop=220~230Vac

5. Chromaticity Diagram & Coordinates

※ Correlated Color Temperature is derived from the CIE 1931 Chromaticity diagram.

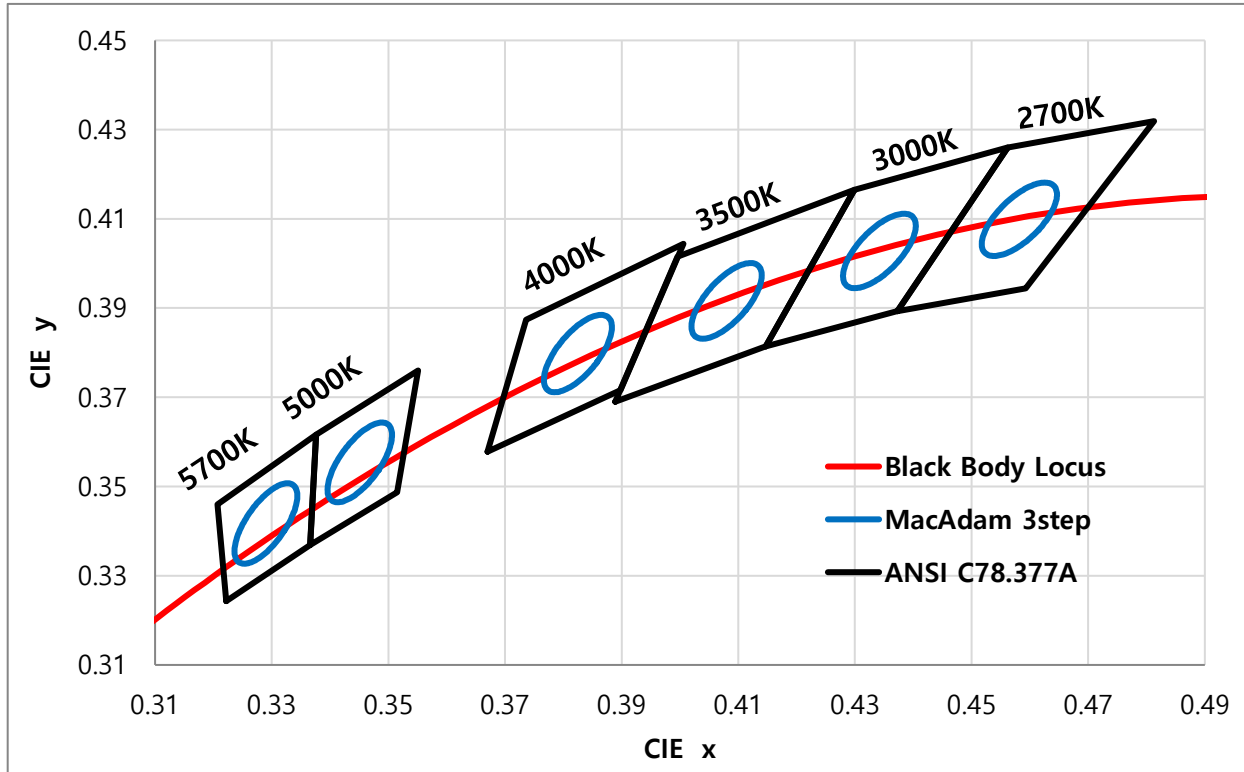

(1) Chromaticity coordinate groups are measured with an accuracy of ± 0.01

CCT(K)	x	y	CCT(K)	x	y	CCT(K)	x	y
5700K	0.3222	0.3243	4000K	0.3670	0.3578	3000K	0.4147	0.3814
	0.3207	0.3462		0.3736	0.3874		0.4299	0.4165
	0.3376	0.3616		0.4006	0.4044		0.4562	0.4260
	0.3366	0.3369		0.3898	0.3716		0.4373	0.3893
5000K	0.3366	0.3369	3500K	0.3889	0.3690	2700K	0.4373	0.3893
	0.3376	0.3616		0.3996	0.4015		0.4562	0.4260
	0.3551	0.3760		0.4299	0.4165		0.4813	0.4319
	0.3515	0.3487		0.4147	0.3814		0.4593	0.3944

* 3-step MacAdam Ellipse Color Definition

CCT(K)	Center		Ellipse Parameter		
	x	y	Axis a	Axis b	Angle(°)
5700K	0.3290	0.3417	0.0099	0.0035	63.7
5000K	0.3451	0.3555	0.0098	0.0036	62.7
4000K	0.3825	0.3800	0.0097	0.0038	60.4
3500K	0.4080	0.3917	0.0097	0.0039	58.6
3000K	0.4343	0.4027	0.0096	0.0040	56.9
2700K	0.4582	0.4099	0.0096	0.0042	55.2

6. Characteristic Graphs

6-1. Voltage Characteristics (Ta=25°C)

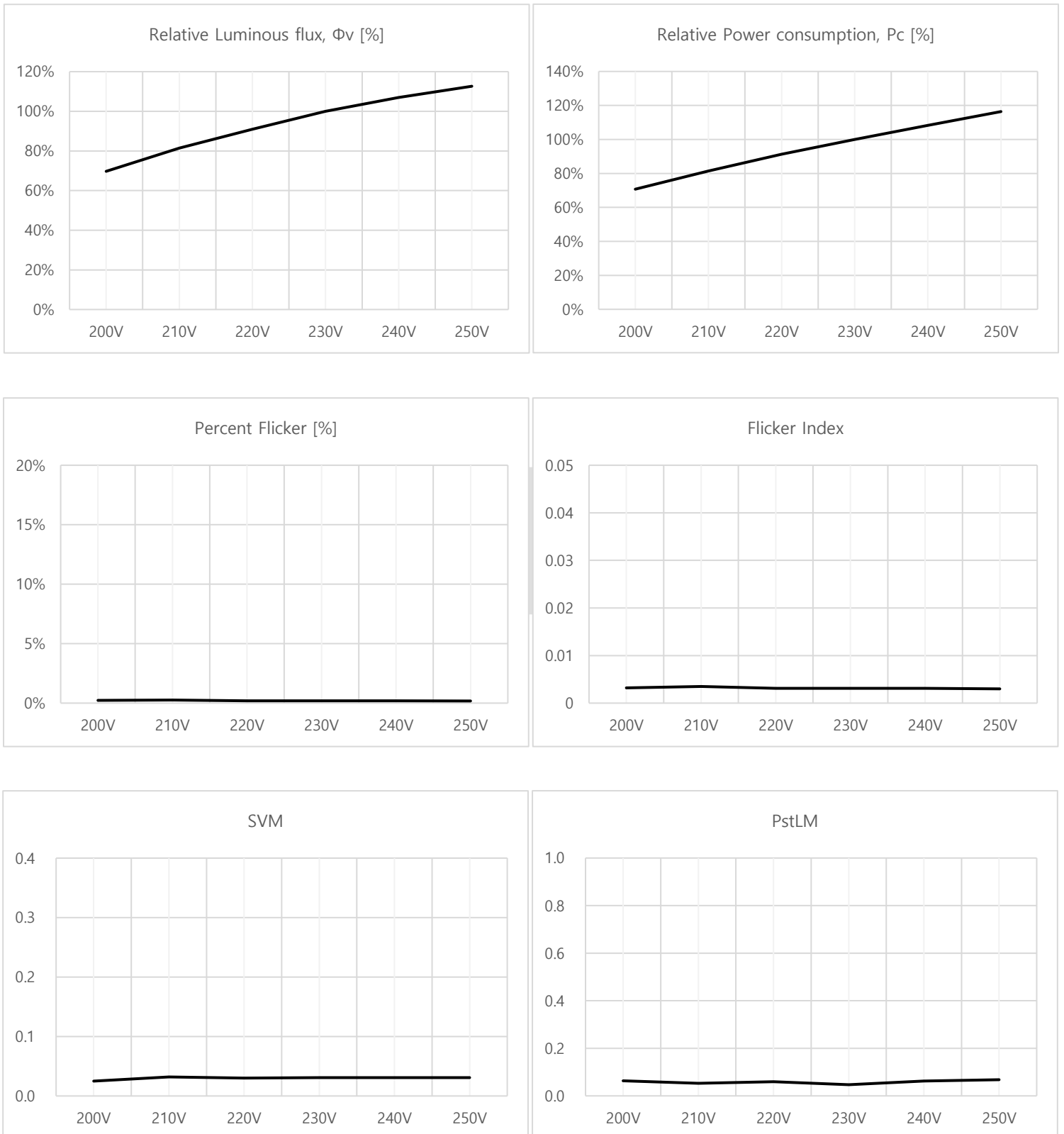

6-2. Spectrum Characteristics (Ta=25°C)

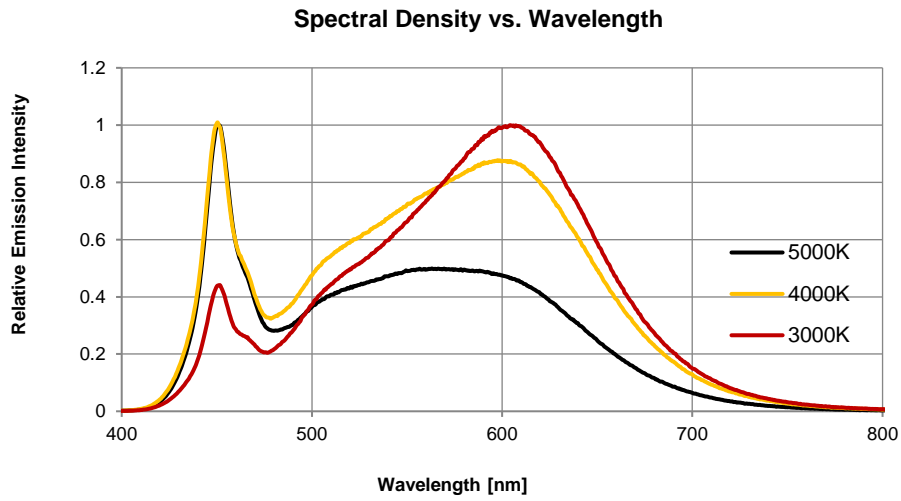

6-3. Temperature Characteristics

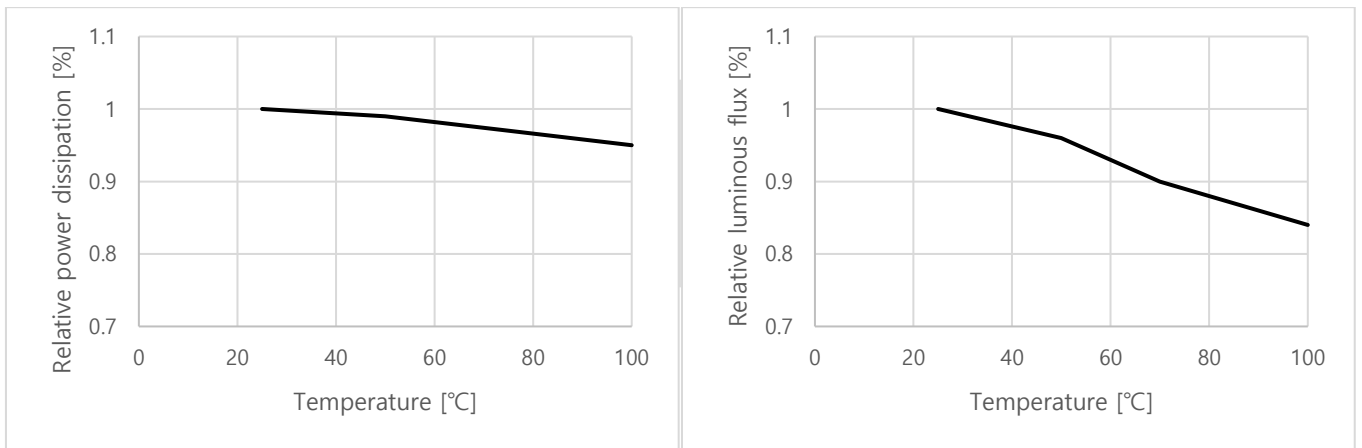

7. Outline Dimensions

7-1. PCB Dimensions

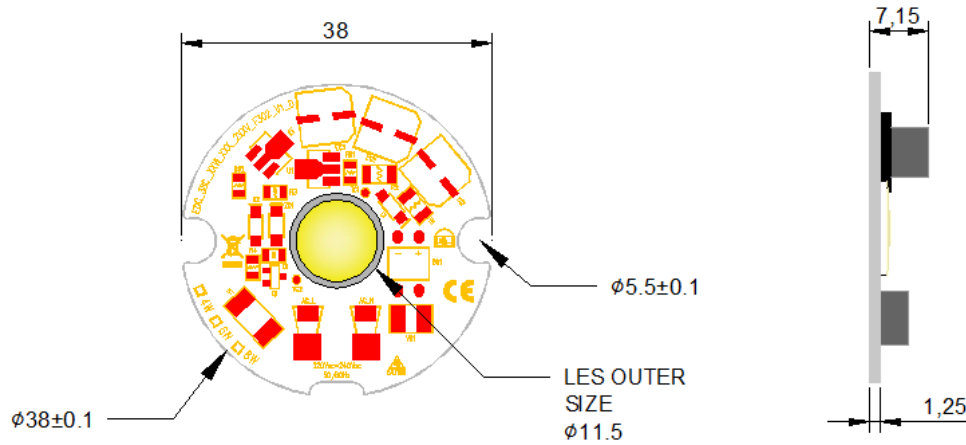

Unit: mm

- 1) Outline Diameter: $\phi 38$, Height: 7.15mm (Include PCB)
- 2) Tolerance - All measurements are ± 0.2 mm unless otherwise indicated.

LUMENS

8. EDC Module Marking

- A. Information Identification by report on the PCB (Silk)
- Module Identification Code
- B. LED Module Laser Marking

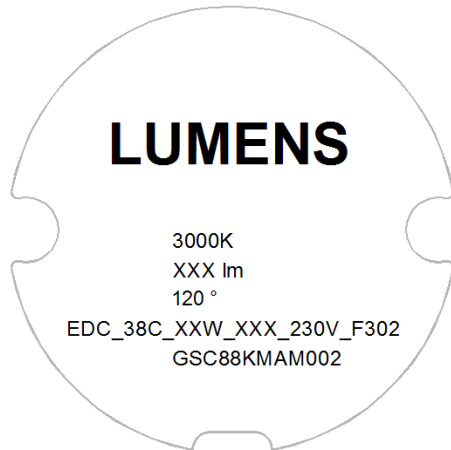

<PCB Bottom>

C. Code Table

No.	Item	Symbol	unit
1	Logo		
2	CCT		K
3	Luminous flux	Φ_v	lm
4	Beam angle	°	Degree
5	Model		
6	WW/YY		
7	Traceability code		

D. Traceability Code Table

No	1	2	3	4	5	6	7	8	9	10	11	12	13
Marking	G	S	0	0	1	C	M	5	W	A	0	0	1
Meaning	SMT Site	Chip Manufacturer	Group No.			SMT Year/Month/Day			PCB Manufacturer	Classification	Serial No.		
Ciphers	1	1	3			3			1	1	4		
How to Use	G : K2	S : Semicon	001			1st Year (A~Z) 2nd : Month(A~M) 3rd : Day(A~Z,1~7)			W : Wavenics	A	001		

E. Traceability Code Marking Table

SMT Site

SMT Site	D	L	B	K	Y	W	H	G	T
Code	1 st Vendor	2 nd Vendor	3 rd Vendor	4 th Vendor	5 th Vendor	6 th Vendor	7 th Vendor	8 th Vendor	9 th Vendor

Chip Manufacturer

Chip Manufacturer	F	P	E	T	K	I	V	G	O	S
Code	1 st Vendor	2 nd Vendor	3 rd Vendor	4 th Vendor	5 th Vendor	6 th Vendor	7 th Vendor	8 th Vendor	9 th Vendor	10 th Vendor

SMT Year/Month/Day

Year	2012	2013	2014	2015	2016	2017	2018	2019	2020	2021	2022	2023	2024	2025	2026	2027	2028	2029	2030	2031	2032	2033	2034	2035							
	A	B	C	D	E	F	G	H	J	K	L	M	N	P	Q	R	S	T	U	V	W	X	Y	Z							
Month	1	2	3	4	5	6	7	8	9	10	11	12																			
	A	B	C	D	E	F	G	H	J	K	L	M																			
Day	1	2	3	4	5	6	7	8	9	10	11	12	13	14	15	16	17	18	19	20	21	22	23	24	25	26	27	28	29	30	31
	A	B	C	D	E	F	G	H	J	K	L	M	N	P	Q	R	S	T	U	V	W	X	Y	Z	1	2	3	4	5	6	7

PCB Manufacturer

PCB Manufacturer	F	P	E	T	K	I	V	G	O	S
Code	1 st Vendor	2 nd Vendor	3 rd Vendor	4 th Vendor	5 th Vendor	6 th Vendor	7 th Vendor	8 th Vendor	9 th Vendor	10 th Vendor

9. Package and Marking of Product

A. Tray Information

Size: 195.5mm x 185.5mm x 15.0mm

Color: Clear

Surface Resistivity: $10^6 \sim 10^9 \Omega/\text{Sq}$.

B. Package

10 pcs are packed in one tray.

Packing tray: Stack up 9 Layers x 2 Sets

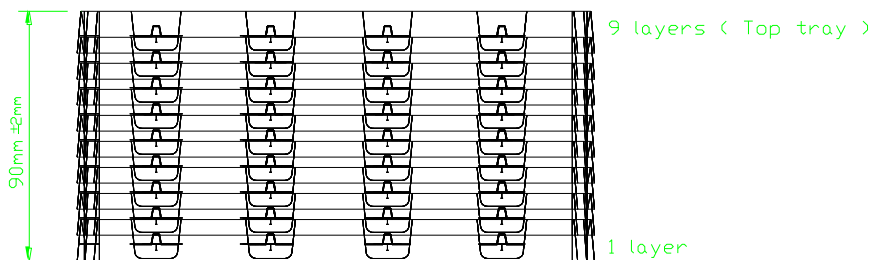
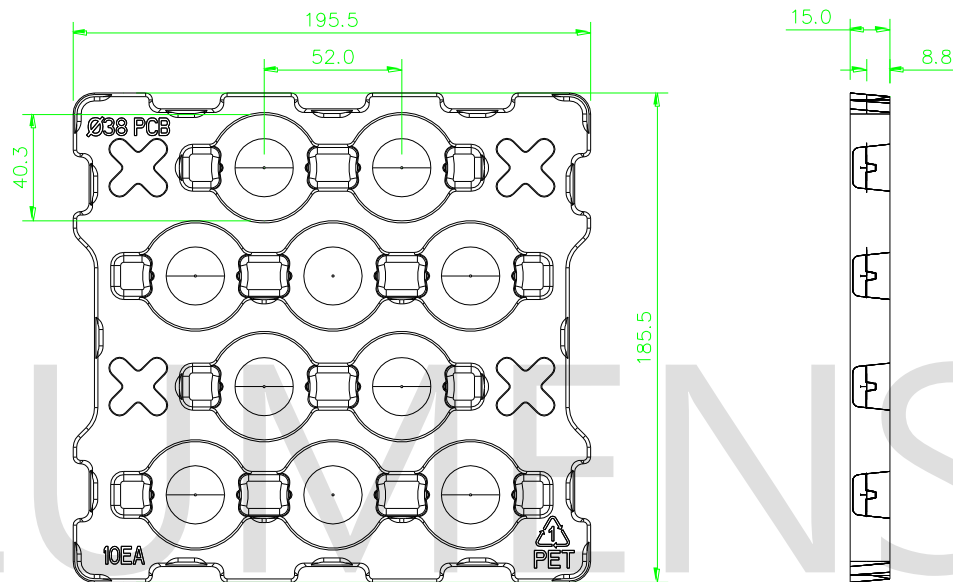

Stack up 9 layers x 2 Sets
- Packing tray -

C. Box Packing Specifications

Tray products (numbers of products are 10 pcs) packed.

There is no product on the top tray.

18 Tray (total maximum number of products are 160pcs) packed in a box.

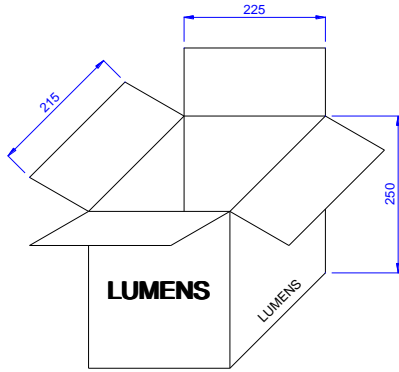

225 x 215 x 250 mm

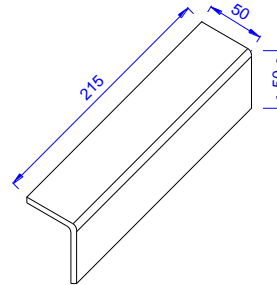

50 x 50 x 215 mm

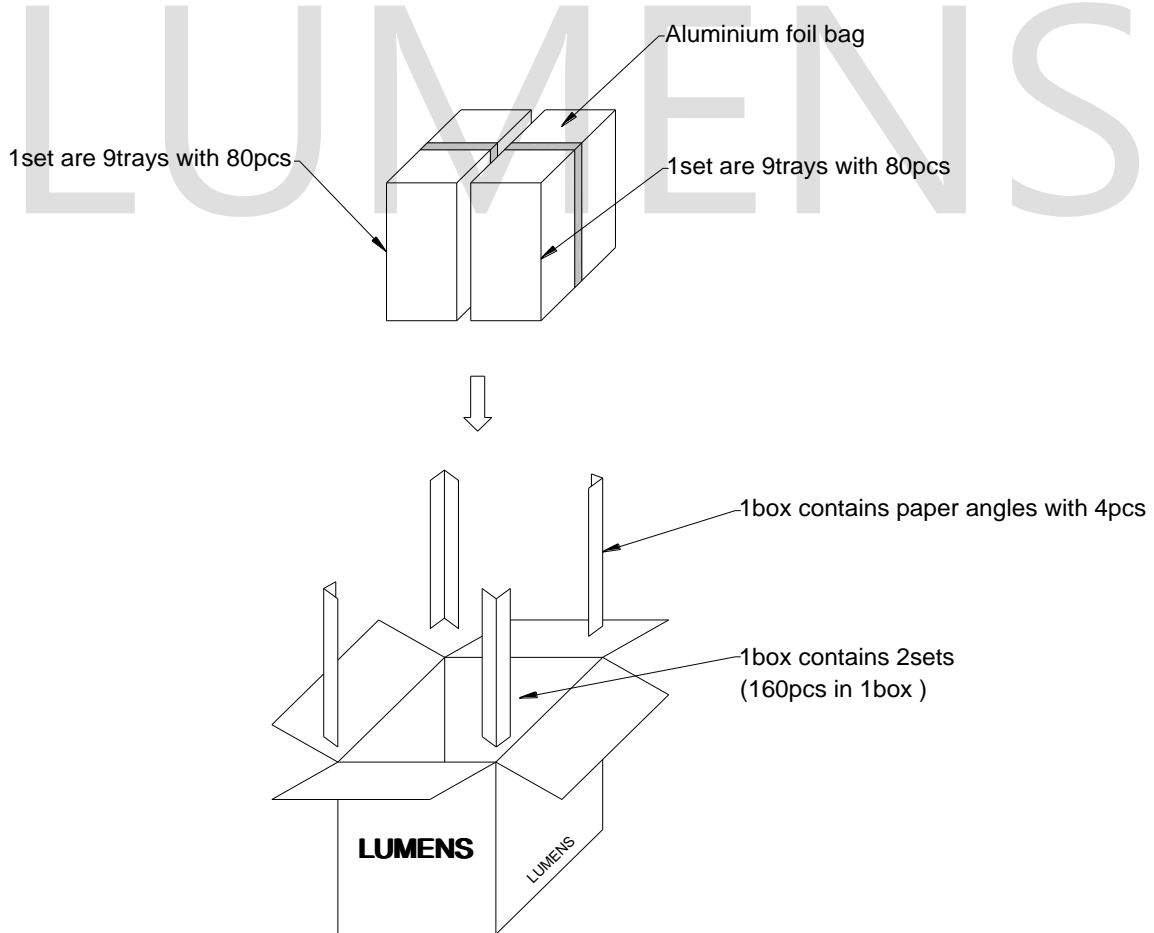

D. Pallet Loading

Box is stacked by 5 layers on the Pallet.
Each layer has 20 boxes.

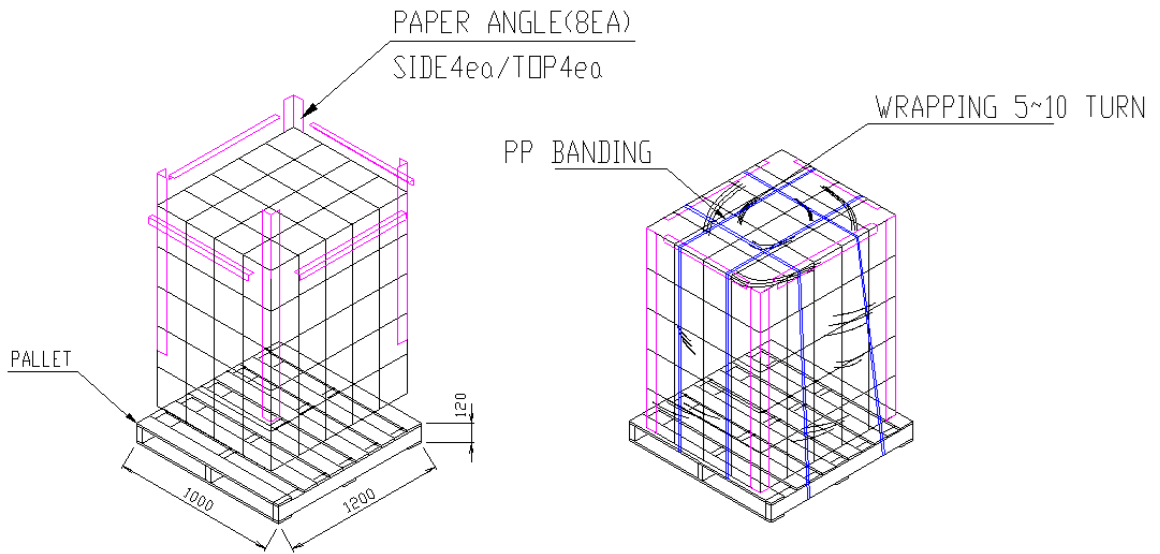

Size : 1,000mm(W) x 1,200mm(L) x 1,560mm(H)

LUMENS

E. BOX Label

Specifying Customer, Model, Customer Part No, Lot No, Quantity
 On both trays and boxes, the same label is attached.

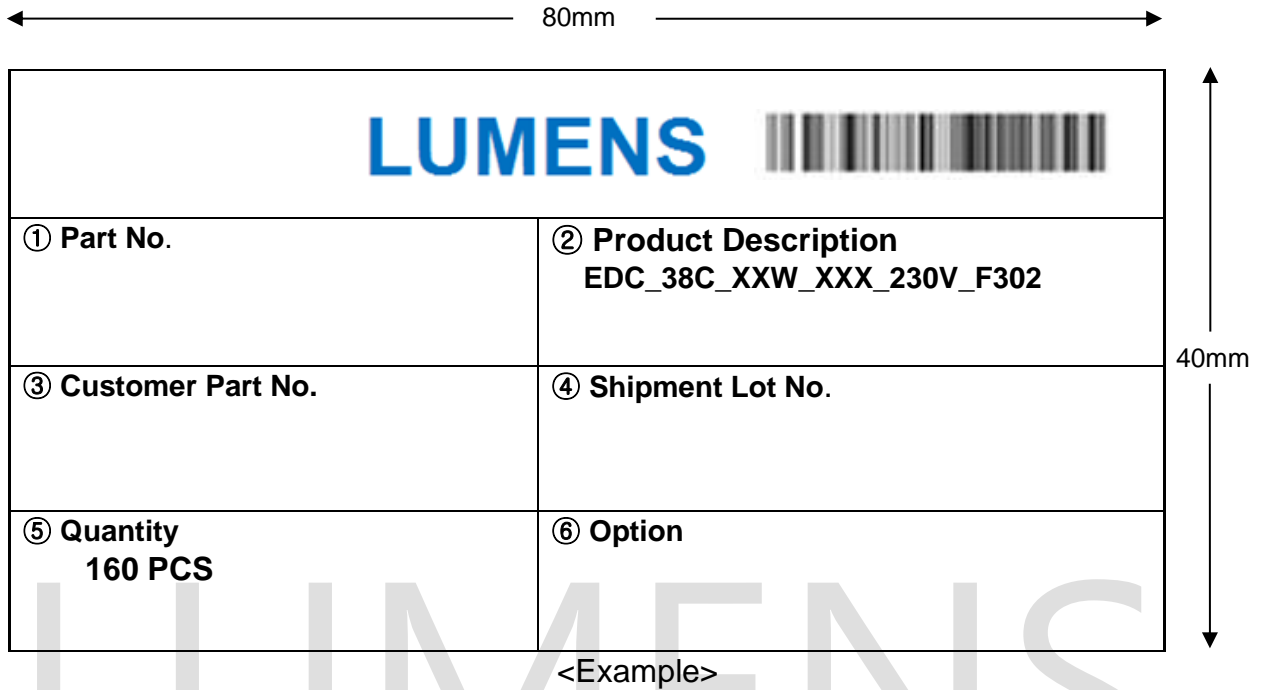

Shipment Lot No. Indication

No	1	2	3	4	5	6	7	8	9	10	11	12	13	14	15	
Marking	C	G	X	-	1	0	0	2	0	2	-	A	0	0	1	
Meaning	COB	SMT Site	Default	Default	Packing Year/Month/Day						Default	Default	Packing serial No.			
Ciphers	1	1			6								3			
How to Use	C : COB	G : K2			1st~2nd : Last two digits of Year 3rd~4th : Month(01~12) 5th~6th : Day(01~31)								001			

10. Cautions

- ◆ The LED Module itself and all its components may not be mechanically stressed.
- ◆ Make sure proper discharge prior to starting work.
- ◆ DO NOT touch any of the circuit board, components or terminals with body or metal while circuit is active.
- ◆ Installation of LED Module needs to be made with regard to all applicable electrical and safety standards. Only qualified personnel should be allowed to perform installation.
- ◆ DO NOT add or change wires while circuit is active.
- ◆ DO NOT make any modification on module.
- ◆ DO NOT use adhesives to attach the LED that outgas organic vapor.
- ◆ DO NOT use together with the materials containing Sulfur.
- ◆ The LED Module needs to be mounted on a heat sink providing adequate thermal dissipation.
- ◆ DO NOT exceed the values given in this specification.
- ◆ Be cautious when soldering to board so as not to create a short between different trace patterns.
- ◆ Keep cautions not to apply higher voltage above the maximum rating. Otherwise, damage may occur.
- ◆ Pay attention not to exceed the maximum operation temperature of 85°C at the Tc1 Point when the modules are used in an enclosed environment. (Tc1 Temperature Condition $\leq 85^{\circ}\text{C}$)
($T_{c1} + 30^{\circ}\text{C} \doteq \text{Maximum LES temperature}(T_j)$) : Depends on specification of heat sink
- ◆ DO NOT assemble in conditions of high moisture and/or oxidizing gas such as Cl, H₂S, NH₃, SO₂, NO_x, etc.
- ◆ The module should also not be installed in end equipment without ESD (Electrical Static Discharge) protection.
- ◆ Damage by corrosion will not be allowed as defect claim. Lumens LED Module is recommended for Indoor use only.
- ◆ Great care should be taken not to see directly the operated lighting LED. If not the intense light should cause the damage to eye. Use proper goggles to protect your eyes during operation.
- ◆ Long time exposure to sunlight or UV can cause the lens to discolor.
- ◆ Moisture-Proof package
 1. When moisture is absorbed into the LED light engine it may vaporize and expand products during manufacturing. There is a possibility that this may cause exfoliation of the contacts and damage to the optical characteristics of the LEDs. For this reason, the moisture-proof pack is used to keep moisture to a minimum in the package.
 2. A pack of a moisture-absorbent material (silica gel) is inserted into the shielding bag. The silica gel changes its color from blue to pink as it absorbs moisture.
- ◆ Storage Conditions
 1. Before opening the package: The LED light engines should be kept at 30°C or less and 90% RH or less. The LED light engines should be used within a year. When storing the LED light engines, moisture-proof packaging with moisture-absorbent material (silica gel) is recommended.
 2. After opening the package: The LED light engines should be kept at 30°C or less and 70% RH or less. The LEDs should be soldered within 168 hours (7 days) after opening the package. If unused LED light engines remain, they should be stored in moisture-proof packages, such as sealed containers with packages of moisture-absorbent material (silica gel). It is also recommended to return the LED light engines to the original moisture-proof bag and to reseal the moisture-proof bag again.
 3. Please avoid rapid transitions in ambient temperature, especially in high humidity environments where condensation can occur.
- ◆ Basic insulation is based on 230Vac.



NOTE :

All the information published by Lumens is considered to be accurate and reliable. However Lumens does not warrant that product descriptions or other contents in this data sheet is accurate, complete, reliable, current, or error-free. Lumens disclaims any and all warranties and liabilities of an kind, including without limitation, warranties of non-infringement or implied warranty of merchantability of fitness for a particular purpose. The appearance and specifications of the product can be changed to improve quality, performance and/or design without advance notice. Lumens products are not authorized for use as critical components in life support devices or systems without the express written approval from the managing director of Lumens.