

Datasheet

EDC/47C/15W/XXX/230V/A001

- Compatible with most TRIAC dimmers
- High Power Conversion Efficiency (>0.85)
- High Power Factor (>0.99)
- Low THD (<20%)
- Zhaga Standard Mounting Holes
- 78mA Inrush current
- Energy Class A+
- No photo-biological hazard (RG0/RG1)



1. Product Description

* Description

- The EDC(Egg Drop COB) series module is designed for the high power operation to get the high flux output applications.
- It incorporates the state of the art SMD LEDs with high reliability and semiconductor AC direct drive ICs.
- It is ideal for the indoor or down light applications.

* Features

- High performance, High brightness
- No emission of harmful short wavelength light(No UV radiation)
- High power conversion efficiency(>0.85)
- High power factor (>0.99)
- Low THD(< 20%)
- Low EMI
- RoHS compliant
- No photo-biological hazard – Group 0 (RG0) or Group 1 (Low risk) (RG1)

* Applications

- Down Light (Indoor Lighting)
- Spot Light

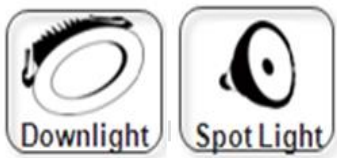

LUMENS

2. Absolute Maximum Ratings

Parameters	Symbol	Min Value	Max Value	Unit
Maximum power dissipation	Pd	-	16.5	W
Maximum operation voltage	Vop	-	250	V
Operation temperature	Top	-40	+85	°C
Storage temperature	Tst	-40	+100	°C

- Operation temperature is not related to the lifetime.

3. Product Name Method

(ex. Eggdrop)



Eggdrop											
EDC	57	C	XXW	X	XX	XXXV	A	0	0	0	V1_0
EggDrop	PCB	'C'= Circular	'Power'= 4 Watt	'7'= 70Ra+	'27'= 2700K	Input	type	Management code			
	'size'= 38mm Ø		6 Watt	'8'= 80Ra+	'30'= 3000K	Voltage	'A'=A				
	47mm Ø		8 Watt	'9'= 90Ra+	'35'= 3500K	230V	'B'=B				
	57mm Ø		10 Watt		'40'= 4000K						
			12 Watt		'50'= 5000K	Or	'C'=C				
			15 Watt		'57'= 5700K	120V					
			20Watt								
			30Watt								
			40Watt								

1) Additional explanation

Product Family	Product Section		Product Description								
			PCB > shape > Watt > CRI+CCT > IV > Type > Management code								
AC Module	Eggdrop	EDC	EDC_57C_XXW_XXX_XXXV_A000_V1_0								

4. Electro-optical Characteristics (T_c=25°C & 55°C.)

Parameters	Symbol	T _c = 25°C			T _c = 55°C			Unit	Condition
		Min.	Typ.	Max.	Min.	Typ.	Max.		
Luminous Flux	Φ _v	1275	1425	-	1200	1350	-	lm	V _{op} =230V,2700K,CRI80
		1350	1500	-	1275	1425	-		V _{op} =230V,3000K,CRI80
		1365	1515	-	1290	1440	-		V _{op} =230V,3500K,CRI80
		1395	1545	-	1320	1470	-		V _{op} =230V,4000K,CRI80
		1425	1575	-	1350	1500	-		V _{op} =230V,5000K,CRI80
		1125	1275	-	1050	1200	-		V _{op} =230V,2700K,CRI90
		1200	1350	-	1125	1275	-		V _{op} =230V,3000K,CRI90
		1230	1380	-	1155	1305	-		V _{op} =230V,3500K,CRI90
		1275	1425	-	1200	1350	-		V _{op} =230V,4000K,CRI90
		1200	1350	-	1125	1275	-		V _{op} =230V,5000K,CRI90
Efficiency	lm/W	85	95	-	80	90	-	lm/W	V _{op} =230V,2700K,CRI80
		90	100	-	85	95	-		V _{op} =230V,3000K,CRI80
		91	101	-	86	96	-		V _{op} =230V,3500K,CRI80
		93	103	-	88	98	-		V _{op} =230V,4000K,CRI80
		95	105	-	90	100	-		V _{op} =230V,5000K,CRI80
		75	85	-	70	80	-		V _{op} =230V,2700K,CRI90
		80	90	-	75	85	-		V _{op} =230V,3000K,CRI90
		82	92	-	77	87	-		V _{op} =230V,3500K,CRI90
		85	95	-	80	90	-		V _{op} =230V,4000K,CRI90
		80	90	-	75	85	-		V _{op} =230V,5000K,CRI90

(1) At 230Vac, T_c = 25 °C & 55°C

(2) Φ_v is the total luminous flux output measured with an integrated sphere.

- Measurement accuracy : CRI(±3), Φ_v(±3%), Vf(±3.0V)

(3) Correlated Color Temperature is derived from the CIE 1931 Chromaticity diagram.

Correlated Color Temperature	CCT	MacAdam 3Step			K	
Color Rendering Index	CRI	80/90	-	-	-	V _{op} =230V
Viewing Angle FWHM	2θ1/2	110	120	130	deg	V _{op} =230V
Operation Voltage	V _{op}	210	230	250	V	
Power Dissipation	P _d	13.5	15	16.5	W	V _{op} =230V
Operation Frequency	F _{op}	50 / 60			Hz	V _{op} =230V
Power Factor	PF	Over 0.99			V	V _{op} =230V
Current THD	ATHD	Less than 20%				V _{op} =230V

5. CIE Chromaticity Diagram

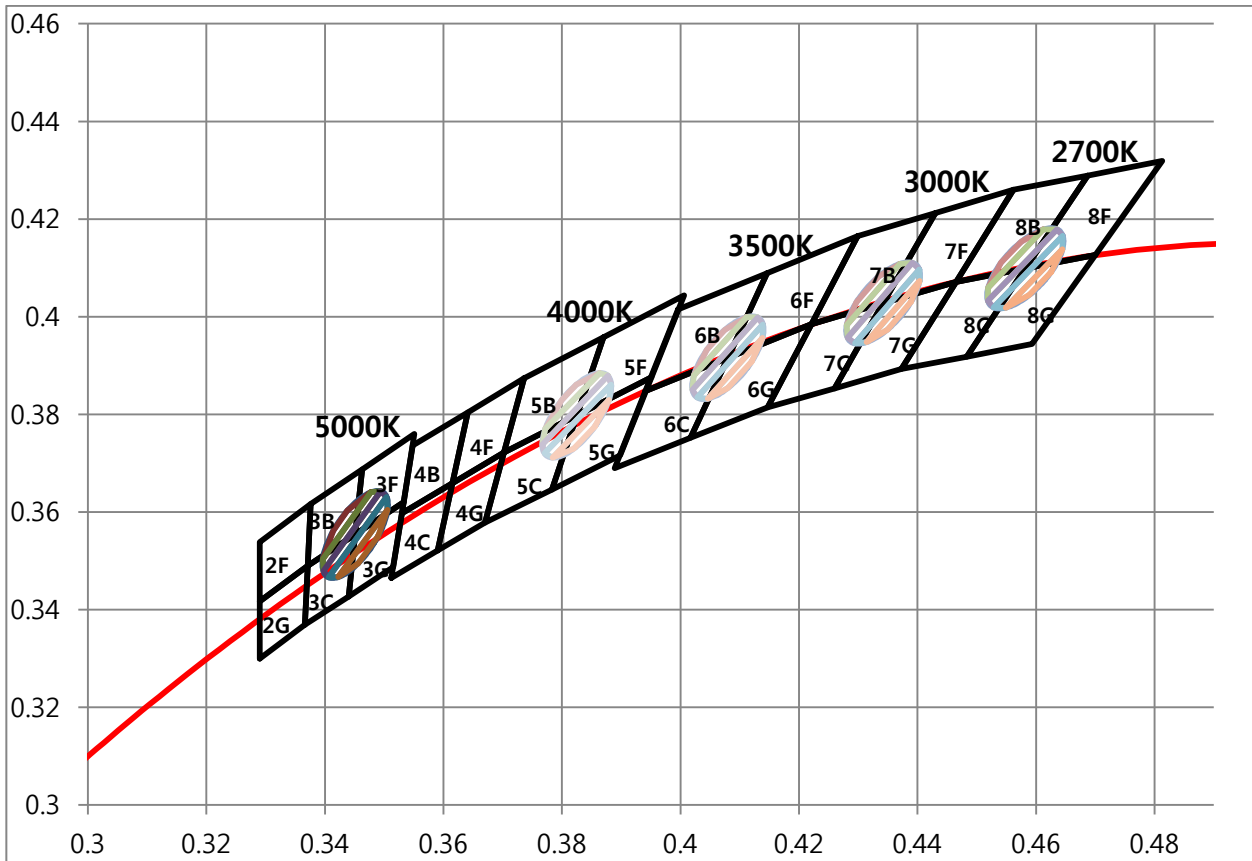

(1) Lumens maintains a tolerance of ± 0.005 on chromaticity (CCx, CCy)

6. Chromaticity Coordinates

6-1. 2700K

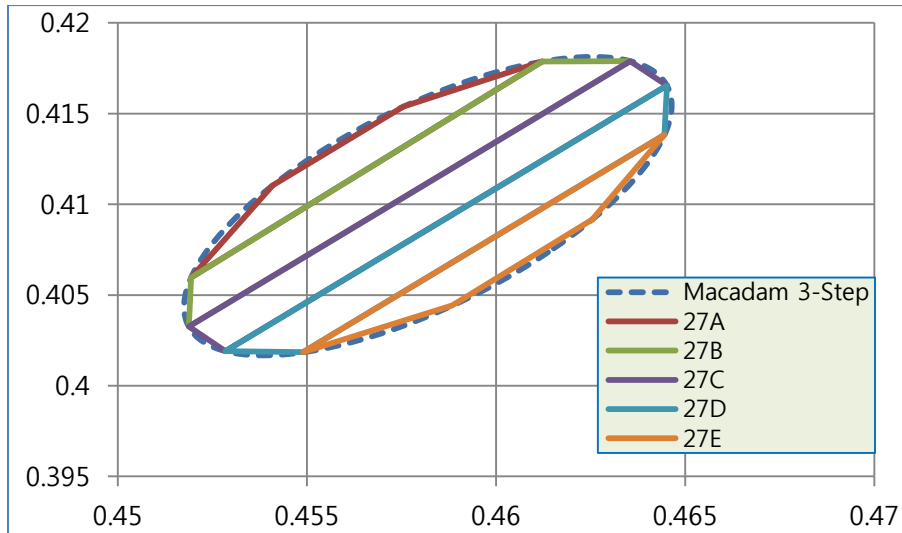

27A		27B		27C		27D		27E	
X	Y	X	Y	X	Y	X	Y	X	Y
0.4612	0.4179	0.4636	0.4179	0.4645	0.4165	0.4645	0.4138	0.4625	0.4092
0.4576	0.4154	0.4612	0.4179	0.4636	0.4179	0.4645	0.4165	0.4645	0.4138
0.4541	0.4110	0.4519	0.4060	0.4519	0.4033	0.4528	0.4019	0.4549	0.4018
0.4519	0.4060	0.4519	0.4033	0.4528	0.4019	0.4549	0.4018	0.4588	0.4044
0.4612	0.4179	0.4636	0.4179	0.4645	0.4165	0.4645	0.4138	0.4625	0.4092

6-2. 3000K

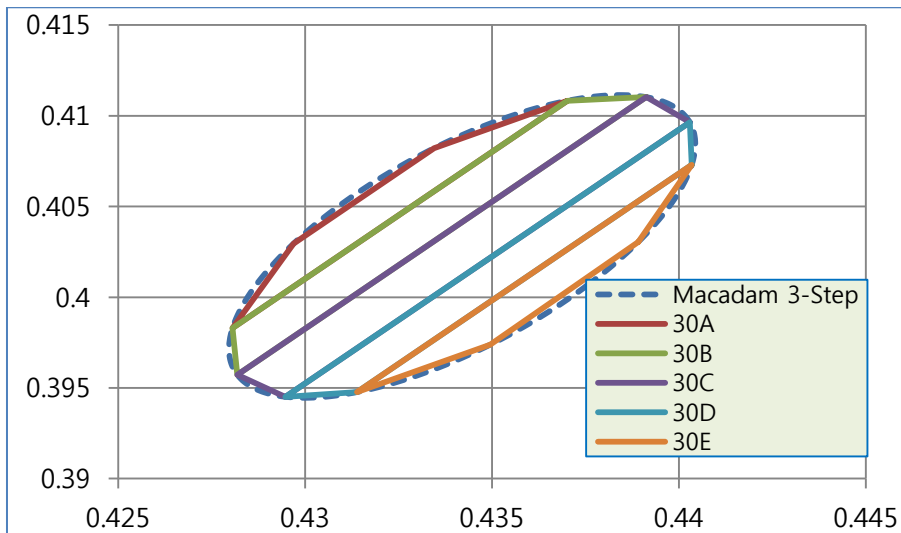

30A		30B		30C		30D		30E	
X	Y	X	Y	X	Y	X	Y	X	Y
0.4370	0.4108	0.4391	0.4110	0.4403	0.4097	0.4403	0.4073	0.4389	0.4031
0.4334	0.4082	0.4370	0.4108	0.4391	0.4110	0.4403	0.4097	0.4403	0.4073
0.4297	0.4030	0.4281	0.3983	0.4282	0.3957	0.4295	0.3945	0.4314	0.3948
0.4281	0.3983	0.4282	0.3957	0.4295	0.3945	0.4314	0.3948	0.4350	0.3974
0.4370	0.4108	0.4391	0.4110	0.4403	0.4097	0.4403	0.4073	0.4389	0.4031

6-3. 3500K

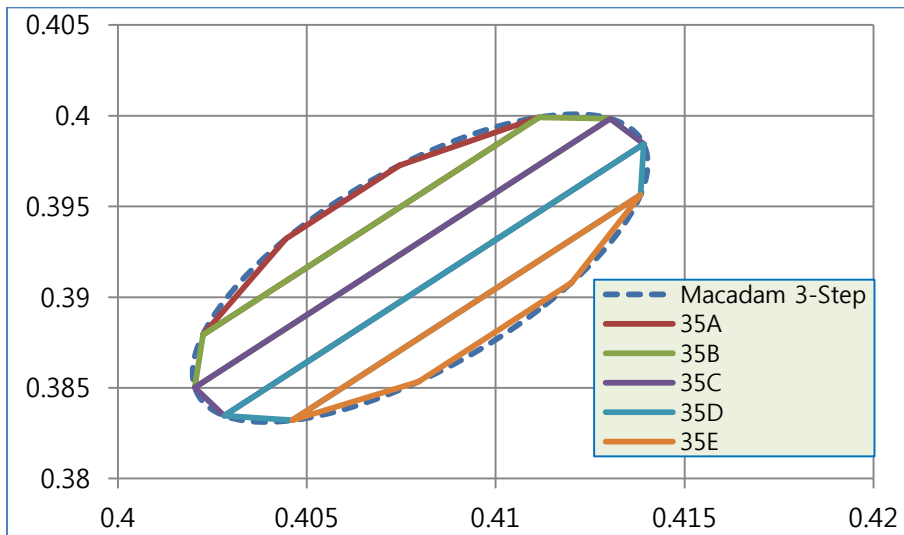

35A		35B		35C		35D		35E	
X	Y	X	Y	X	Y	X	Y	X	Y
0.4111	0.3999	0.4130	0.3998	0.4139	0.3984	0.4138	0.3956	0.4120	0.3908
0.4075	0.3973	0.4111	0.3999	0.4130	0.3998	0.4139	0.3984	0.4138	0.3956
0.4044	0.3932	0.4023	0.3879	0.4020	0.3850	0.4028	0.3835	0.4046	0.3832
0.4023	0.3879	0.4020	0.3850	0.4028	0.3835	0.4046	0.3832	0.4080	0.3853
0.4111	0.3999	0.4130	0.3998	0.4139	0.3984	0.4138	0.3956	0.4120	0.3908

6-4. 4000K

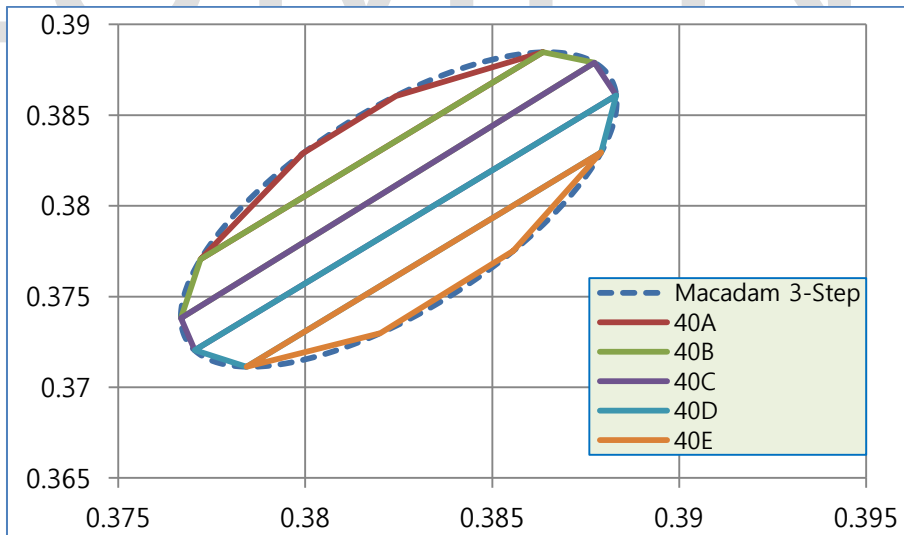

40A		40B		40C		40D		40E	
X	Y	X	Y	X	Y	X	Y	X	Y
0.3864	0.3885	0.3877	0.3879	0.3883	0.3861	0.3879	0.3829	0.3856	0.3775
0.3824	0.3861	0.3864	0.3885	0.3877	0.3879	0.3883	0.3861	0.3879	0.3829
0.3799	0.3829	0.3772	0.3771	0.3767	0.3738	0.3770	0.3720	0.3784	0.3711
0.3772	0.3771	0.3767	0.3738	0.3770	0.3720	0.3784	0.3711	0.3820	0.3730
0.3864	0.3885	0.3877	0.3879	0.3883	0.3861	0.3879	0.3829	0.3856	0.3775

6-5. 5000K

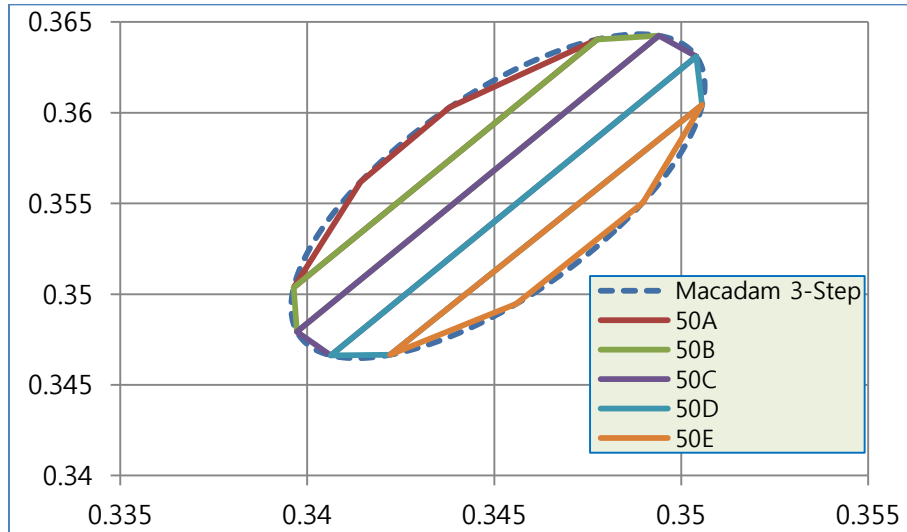

50A		50B		50C		50D		50E	
X	Y	X	Y	X	Y	X	Y	X	Y
0.3478	0.3640	0.3494	0.3642	0.3504	0.3631	0.3506	0.3604	0.3490	0.3550
0.3438	0.3603	0.3478	0.3640	0.3494	0.3642	0.3504	0.3631	0.3506	0.3604
0.3414	0.3562	0.3396	0.3504	0.3397	0.3479	0.3406	0.3466	0.3422	0.3467
0.3396	0.3504	0.3397	0.3479	0.3406	0.3466	0.3422	0.3467	0.3456	0.3495
0.3478	0.3640	0.3494	0.3642	0.3504	0.3631	0.3506	0.3604	0.3490	0.3550

7. Characteristic Graphs

7-1 Voltage Characteristics(Ta=25°C)

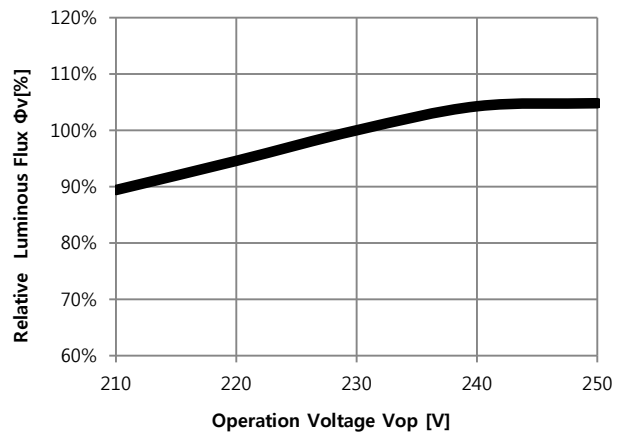
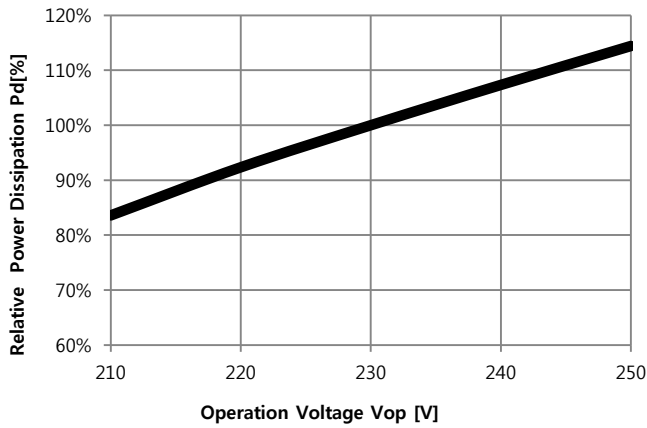

7-2 Spectrum Characteristics(Ta=25°C)

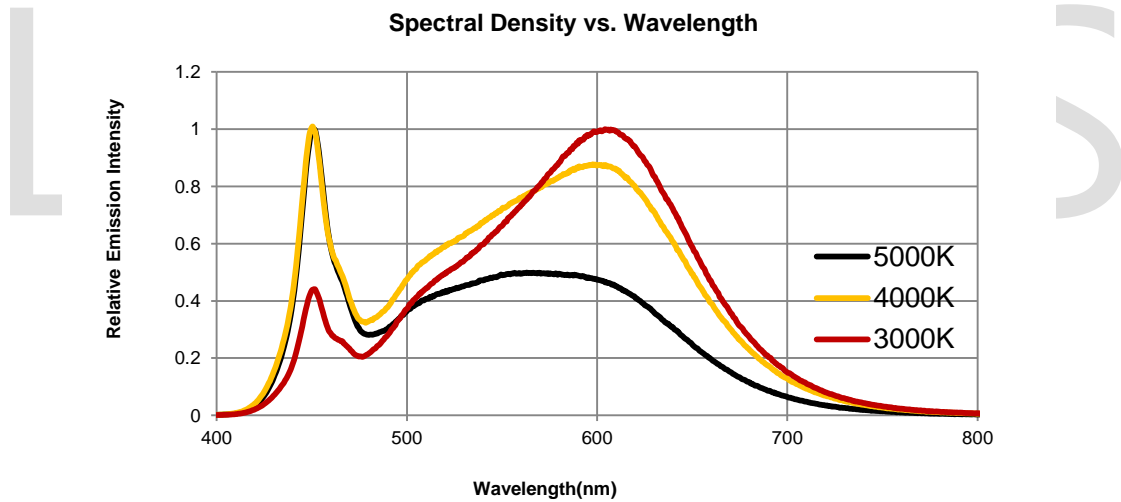

7-3 Temperature Characteristics

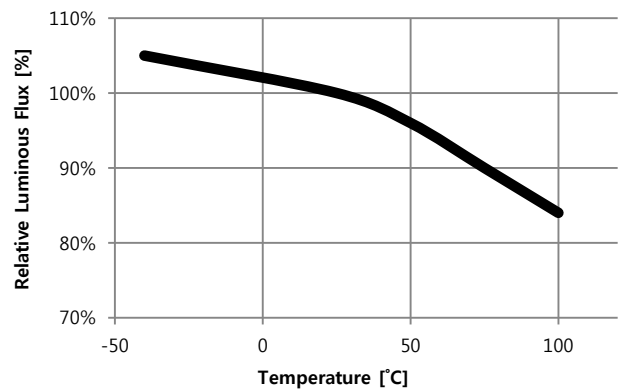
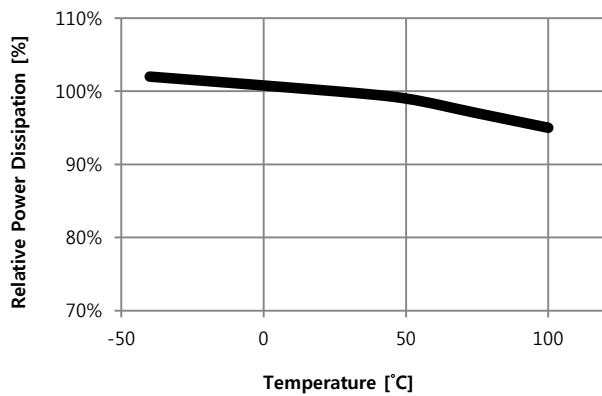

8. Outline Dimensions

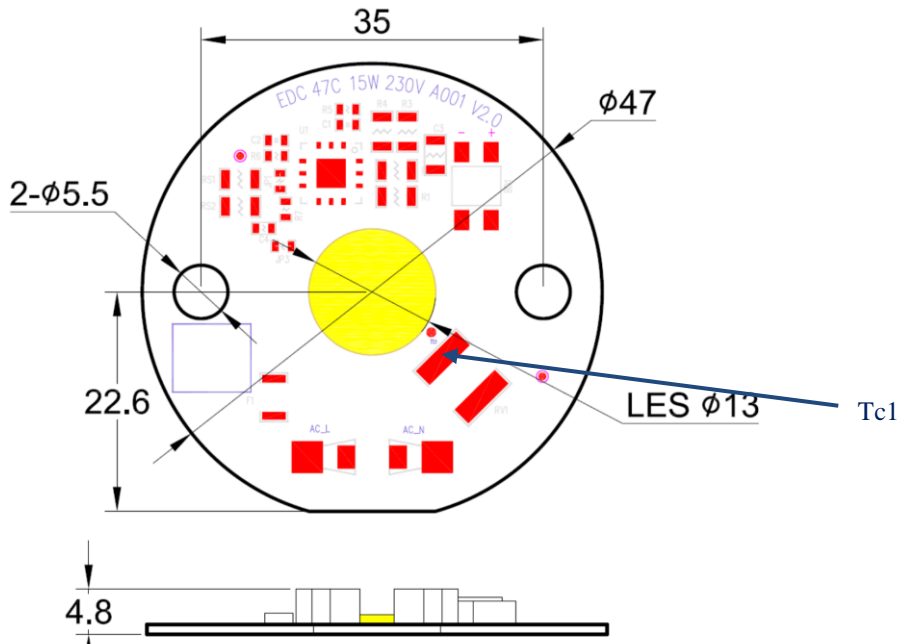

* LES = Light Emitted Surface

Unit : mm

- 1) Outline Diameter : 47 Φ Height(max) : 4.8mm
- 2) Tolerance - All measurements are ± 0.1 mm unless otherwise indicated.



9. EDC Module Marking

- A. Information Identification by report on the PCB (Silk)
 - Module Identification Code
- B. LED Module Laser Marking



<PCB Bottom>

B-1 Traceability Code Table

No	1	2	3	4	5	6	7	8	9	10	11	12	13
Marking	G	S	0	0	1	C	M	5	W	A	0	0	1
Meaning	SMT Site	Chip Manufacturer	Group No.			SMT Year/Month/Day			PCB Manufacturer	Classification	Serial No.		
Ciphers	1	1	3			3			1	1	4		
How to Use	G : K2	S : Semicon	001			1st Year (A~Z) 2nd : Month(A~M) 3rd : Day(A~Z,1~7)			W : Waverics	A	001		

B-2 Traceability Code Marking Table

SMT Site

SMT Site	D	L	B	K	Y	W	H	G	T
Code	1 st Vendor	2 nd Vendor	3 rd Vendor	4 th Vendor	5 th Vendor	6 th Vendor	7 th Vendor	8 th Vendor	9 th Vendor

Chip Manufacturer

Chip Manufacturer	F	P	E	T	K	I	V	G	O	S
Code	1 st Vendor	2 nd Vendor	3 rd Vendor	4 th Vendor	5 th Vendor	6 th Vendor	7 th Vendor	8 th Vendor	9 th Vendor	10 th Vendor

SMT Year/Month/Day

Year	2012	2013	2014	2015	2016	2017	2018	2019	2020	2021	2022	2023	2024	2025	2026	2027	2028	2029	2030	2031	2032	2033	2034	2035							
	A	B	C	D	E	F	G	H	J	K	L	M	N	P	Q	R	S	T	U	V	W	X	Y	Z							
month	01월	02월	03월	04월	05월	06월	07월	08월	09월	10월	11월	12월																			
	A	B	C	D	E	F	G	H	J	K	L	M																			
day	01일	02일	03일	04일	05일	06일	07일	08일	09일	10일	11일	12일	13일	14일	15일	16일	17일	18일	19일	20일	21일	22일	23일	24일	25일	26일	27일	28일	29일	30일	31일
	A	B	C	D	E	F	G	H	J	K	L	M	N	P	Q	R	S	T	U	V	W	X	Y	Z	1	2	3	4	5	6	7

PCB Manufacturer

PCB Manufacturer	F	P	E	T	K	I	V	G	O	S
Code	1 st Vendor	2 nd Vendor	3 rd Vendor	4 th Vendor	5 th Vendor	6 th Vendor	7 th Vendor	8 th Vendor	9 th Vendor	10 th Vendor

A. LED Module Label

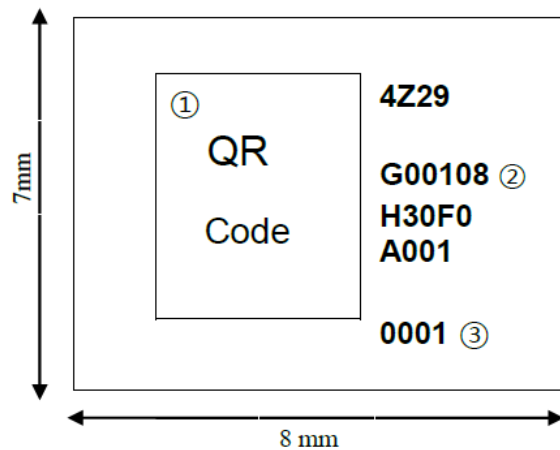
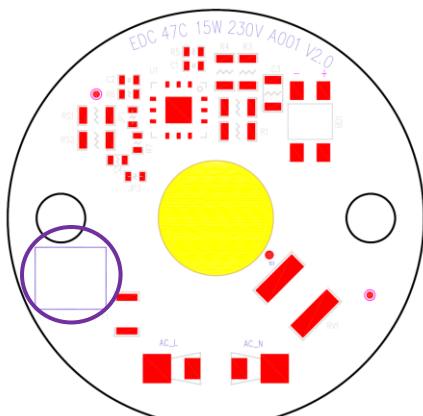

1	QR Code
2	Traceability Code
3	Serial No.

C-1 Traceability Code Table

No	1	2	3	4	5	6	7	8	9	10	11	12	13	14	15	16	17	18	19	20	21	22	23
Marking	4	8	1	5	T	9	9	9	1	8	H	3	0	C	0	A	0	0	1	0	0	0	1
Meaning	SMT Year/Month/Day				SMT Site	Group No.			Watt	CRI	CCT	Volt	Default	LOT Serial No.				SMT Serial No.					
Ciphers	4				1	3			2	1	2	1		4				4					
How to Use	1st: Last No. of Year 2nd: Month (1~9,X,Y,Z) 3rd~4th: Day				T: SMT	999			18	H	30	C		A001				0001					

C-2 Traceability Code Marking Table

SMT Year/Month

code	Year
4	2014
5	2015
6	2016

Month	1	2	3	4	5	6	7	8	9
Code	1	2	3	4	5	6	7	8	9
Month	10	11	12						
Code	X	Y	Z						

SMT Day

Day	1	2	3	4	5	6	7	8	9	10	11
Code	01	02	03	04	05	06	07	08	09	10	11
Day	12	13	14	15	16	17	18	19	20	21	22
Code	12	13	14	15	16	17	18	19	20	21	22
Day	23	24	25	26	27	28	29	30	31		
Code	23	24	25	26	27	28	29	30	31		

SMT Site

SMT Site	D	L	B	K	Y	W	H	G	T
Code	1 st Vendor	2 nd Vendor	3rd Vendor	4 th Vendor	5 th Vendor	6 th Vendor	7 th Vendor	8 th Vendor	9 th Vendor

Watt

Watt	1	2	3	4	5	6	7	8	9	10	...	99
Code	01	02	03	04	05	06	07	08	09	10	...	99
Watt	100	101	...	110	111	...	330	331	...	338	339	etc.
Code	A0	A1	...	B0	B1	...	Z0	Z1	...	Z8	Z9	ZZ

* AO:100, BO:110, CO:120, DO:130, EO:140, FO:150, GO:160, HO:170, JO:180, KO:190, LO:200, MO:210
 NO:220, PO:230, QO:240, RO:250, SO:260, TO:270, UO:280, VO:290, WO:300, XO:310, YO:320, ZO:330

CRI

CRI	Under 70	Min 70	Min 75	Min 80	Min 85	Min 90
Code	L	N	M	H	V	U

CCT

CCT	2700K	3000K	3500K	4000K	4500K	5000K	5700K	6500K
Code	27	30	35	40	45	50	57	65

Volt

Volt	100V	110V	120V	200V	220V	230V	240V	250V	277V	347V	DC	etc.
Code	A	B	C	D	E	F	G	H	J	K	X	Z

10. Package And Marking Of Product

A. Tray Information

Size : 200mm x 190mm x 15.7mm

Color : Clear

Surface Resistivity : $10^6 \sim 10^9 \Omega/Sq.$

B. Package

5 pcs are packed in one tray.

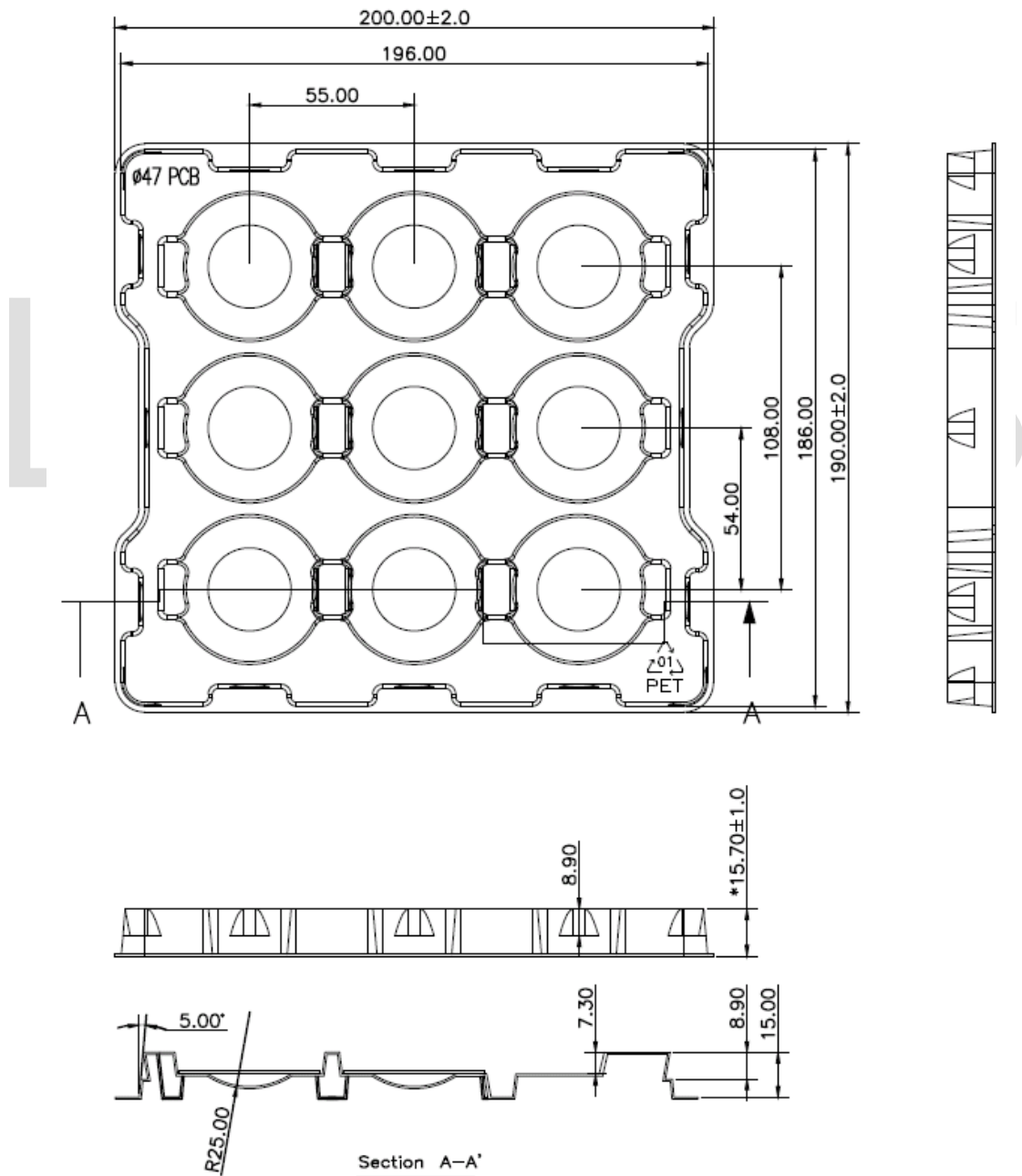

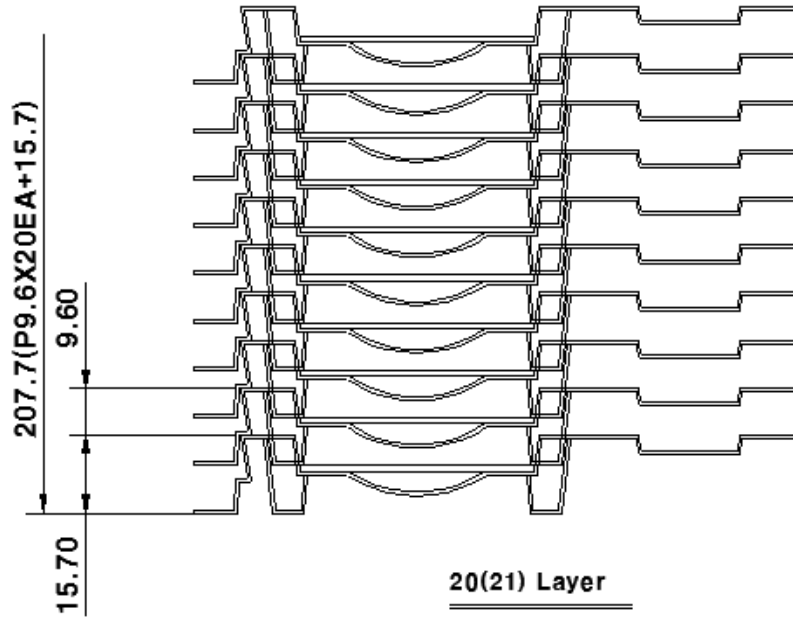

Stack up 21 Layers
 - Packing Tray -

C. Box Packing Specifications

Tray products (numbers of products are 5 pcs) packed.
 There is no product on the top tray
 21 Tray (total maximum number of products are 100pcs) packed in a box.

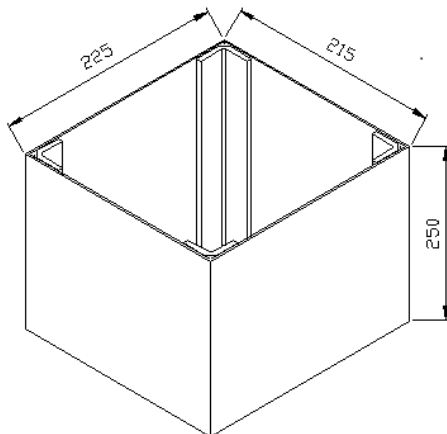

225 X 215 X 250 mm

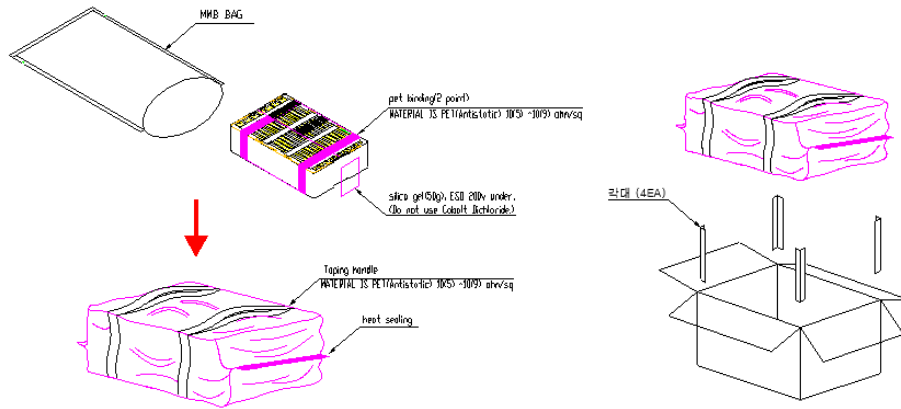

D. Pallet Loading

Box is stacked by 5 layers on the Pallet.
Each layer has 20 boxes

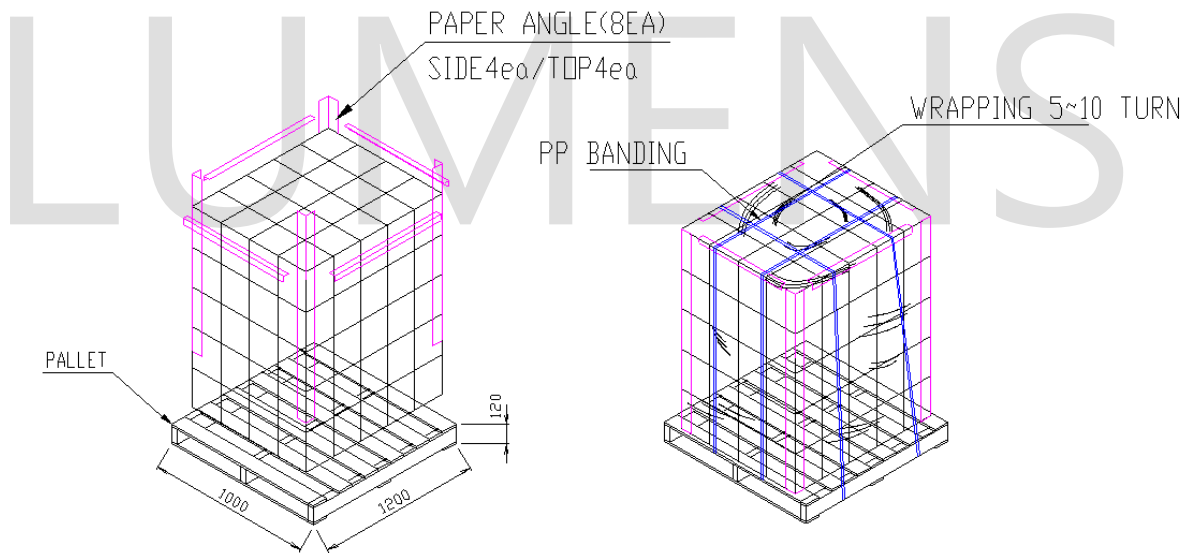

Size : 1,000mm(W) X 1,200mm(L) X 1,380mm(H)

E. BOX Label

Specifying Customer, Model, Customer Part No, Lot No, Quantity
 On both trays and boxes, the same label is attached.

LUMENS			40mm
① Part No.	② Product Description EDC_47C_15W_xxx_230V_A000		
③ Customer Part No.	④ Shipment Lot No.		
⑤ Quantity 180PCS	⑥ Option		

1. PART No
2. Model Name.
3. Customer Part NO
4. Shipment Lot No.
5. Quantity.

F. Shipment Lot No. Indication

No	1	2	3	4	5	6	7	8	9	10	11	12	13	14	15	
Marking	C	G	X	-	1	0	0	2	0	2	-	A	0	0	1	
Meaning	COB	SMT Site	Default	Default	Packing Year/Month/Day						Default	Default	Packing serial No.			
Ciphers	1	1			6								3			
How to Use	C : COB	G : K2	1st~2nd : Last two digits of Year 3rd~4th : Month(01~12) 5th~6th : Day(01~31)						001							

11. Cautions

- ◆ The LED Module itself and all its components may not be mechanically stressed.
- ◆ Make sure proper discharge prior to starting work.
- ◆ DO NOT touch any of the circuit board, components or terminals with body or metal while circuit is active.
- ◆ Installation of LED Module needs to be made with regard to all applicable electrical and safety standards. Only qualified personnel should be allowed to perform installation.
- ◆ DO NOT add or change wires while circuit is active.
- ◆ DO NOT make any modification on module.
- ◆ DO NOT use adhesives to attach the LED that outgas organic vapor.
- ◆ DO NOT use together with the materials containing Sulfur.
- ◆ The LED Module needs to be mounted on a heat sink providing adequate thermal dissipation.
- ◆ DO NOT exceed the values given in this specification
- ◆ Be cautious when soldering to board so as not to create a short between different trace patterns.
- ◆ Keep cautions not to apply higher voltage above the maximum rating. Otherwise damage may occur.
- ◆ Pay attention not to exceed the maximum operation temperature of 85 °C at the Tc1 Point when the modules are used in an enclosed environment.
($T_{c1} + 30\text{ °C} \doteq \text{Maximum LES temperature}(T_j)$) : Depends on specification of heat sink
- ◆ DO NOT assemble in conditions of high moisture and/or oxidizing gas such as Cl, H₂S, NH₃, SO₂, NO_x, etc.
- ◆ The module should also not be installed in end equipment without ESD (Electrical Static Discharge) protection.
- ◆ Damage by corrosion will not be allowed as defect claim. Lumens LED Module is recommended for Indoor use only.
- ◆ Great care should be taken not to see directly the operated lighting LED. If not the intense light should cause the damage to eye. Use proper goggles to protect your eyes during operation.
- ◆ Long time exposure to sunlight or UV can cause the lens to discolor.
- ◆ Moisture-Proof package
 1. When moisture is absorbed into the LED light engine it may vaporize and expand products during manufacturing. There is a possibility that this may cause exfoliation of the contacts and damage to the optical characteristics of the LEDs. For this reason, the moisture-proof pack is used to keep moisture to a minimum in the package.
 2. A pack of a moisture-absorbent material (silica gel) is inserted into the shielding bag. The silica gel changes its color from blue to pink as it absorbs moisture.
- ◆ Storage Conditions
 1. Before opening the package: The LED light engines should be kept at 30 °C or less and 90% RH or less. The LED light engines should be used within a year. When storing the LED light engines, moisture-proof packaging with moisture-absorbent material (silica gel) is recommended.
 2. After opening the package: The LED light engines should be kept at 30 °C or less and 70% RH or less. The LEDs should be soldered within 168 hours (7 days) after opening the package. If unused LED light engines remain, they should be stored in moisture-proof packages, such as sealed containers with packages of moisture-absorbent material (silica gel). It is also recommended to return the LED light engines to the original moisture-proof bag and to reseal the moisture-proof bag again.
 3. Please avoid rapid transitions in ambient temperature, especially in high humidity environments where condensation can occur.

NOTE :



All the information published by Lumens is considered to be accurate and reliable. However Lumens does not warrant that product descriptions or other contents in this data sheet is accurate, complete, reliable, current, or error-free. Lumens disclaims any and all warranties and liabilities of an kind, including without limitation, warranties of non-infringement or implied warranty of merchantability of fitness for a particular purpose. The appearance and specifications of the product can be changed to improve quality, performance and/or design without advance notice. Lumens products are not authorized for use as critical components in life support devices or systems without the express written approval from the managing director of Lumens.