

EDC F2 Series

Flicker Free
Low SVM

EDC/57C/8W/XXX/2XXV/F201

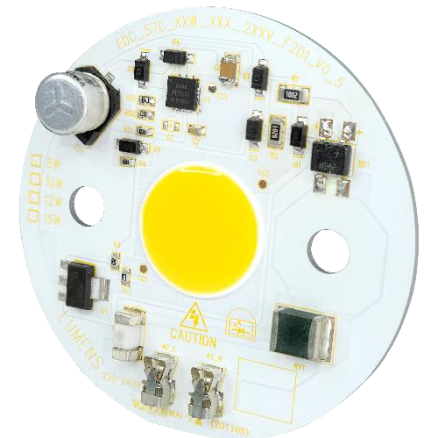

- Compatible with most TRIAC dimmers
- High Power Factor (>0.95)
- Low THD (<30%)
- Zhaga Standard Mounting Holes
- 40mA Inrush current
- No photo-biological hazard (RG1)
- Uniform Full Dimming
- Percent Flicker (<5%)
- Low SVM (<0.1)
- Low Pst (<0.4)

EggDrop®

1. Product Description

* Description

- The EDC(Egg Drop COB) series module is designed for the high power operation to get the high flux output applications.
- It incorporates the state of the art SMD LEDs with high reliability and semiconductor AC direct drive ICs.
- It is ideal for the indoor or down light applications.

* Features

- High performance, High brightness
- No emission of harmful short wavelength light(No UV radiation)
- High power conversion efficiency(>0.85)
- High power factor (>0.95)
- Low THD($\leq 30\%$)
- Low EMI
- RoHS compliant
- No photo-biological hazard –Group 1 (Low risk) (RG1)
- Starting current 35 [mA] @ 60ms
- Percent Flicker (<5%)
- SVM (<0.1)
- Pst (<0.4)

* Applications

- Down Light (Indoor Lighting)
- Spot Light

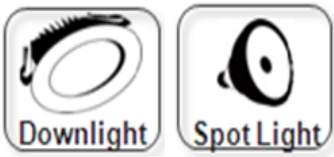

2. Absolute Maximum Ratings

Parameters	Symbol	Min Value	Max Value	Unit
Maximum power dissipation	Pd	-	8.8	W
Maximum operation voltage	Vop	-	250	V
Operation temperature	Top	-40	+85	°C
Storage temperature	Tst	-40	+100	°C

- Operation temperature is not related to the lifetime.

3. Product Name Method

(ex. Eggdrop)

Product Family	PCB Size/shape		Power	CRI+CCT		Input Voltage	Management Code				Version
EDC	57	C	XXW	X	XX	XXXV	F	2	0	1	V0_1
'EDC'=EggDrop	Ø33	'C'=Circular	10W	'7'=70 ↑	'27'=2700K	'120V'=120Vac					
'DLM'=DownLight	Ø38	'R'=Rectangular	15W	'8'=80 ↑	'30'=3000K	'220V'=220Vac					
	Ø47	'D'=Donut	ETC.	'9'=90 ↑	'35'=3500K	'230V'=230Vac					
	Ø57	ETC.			'40'=4000K	ETC.					
	Ø80				'50'=5000K						
'LNM'=Linear Bar	280X20				'57'=5700K						
	560X20										

1) Additional explanation

Product Section		Product Description PCB Size>Shape>Watt>CRI+CCT>InputVoltage>Management Code
EggDrop	EDC	EDC_57C_XXW_XXX_XXXV_F201_V0_1
DownLight	DLM	DLM_80D_XXW_XXX_XXXV_A101_V0_1
Linear Bar	LNM	LNM_280X20_XXW_XXX_XXXV_C101_V0_1

4. Electro-optical Characteristics (Ta=25°C & 55°C.)

Parameters	Symbol	Ta = 25°C			Ta = 55°C			Unit	Condition
		Min.	Typ.	Max.	Min.	Typ.	Max.		
Luminous Flux	Φ_v	729	810	-	696	773	-	lm	2700K,CRI80
		792	880	-	756	840	-		3000K,CRI80
		808	898	-	771	857	-		3500K,CRI80
		824	915	-	787	874	-		4000K,CRI80
		843	937	-	806	895	-		5000K,CRI80
		840	933	-	802	891	-		5700K,CRI80
		627	696	-	598	665	-		2700K,CRI90
		681	757	-	650	723	-		3000K,CRI90
		695	772	-	663	737	-		3500K,CRI90
		708	787	-	676	752	-		4000K,CRI90
		725	806	-	693	770	-		5000K,CRI90
		722	802	-	689	766	-		5700K,CRI90
Efficiency	lm/W	91	101	-	87	97	-	lm / W	2700K,CRI80
		99	110	-	95	105	-		3000K,CRI80
		101	112	-	96	107	-		3500K,CRI80
		103	114	-	98	109	-		4000K,CRI80
		105	117	-	101	112	-		5000K,CRI80
		105	117	-	100	111	-		5700K,CRI80
		78	87	-	75	83	-		2700K,CRI90
		85	95	-	81	90	-		3000K,CRI90
		87	96	-	83	92	-		3500K,CRI90
		89	98	-	85	94	-		4000K,CRI90
		91	101	-	87	96	-		5000K,CRI90
		90	100	-	86	96	-		5700K,CRI90

(1) At 220~230Vac, T_c = 25°C & 55°C(2) Φ_v is the total luminous flux output measured with an integrated sphere.- Measurement accuracy : CRI(±3), Φ_v (±3%), Vf(±3.0V)

Viewing Angle FWHM	2θ1/2	110	120	130	deg	Vop=220~230V
Operation Voltage	Vop	220 ~ 230V			Vac	
Power Dissipation	Pd	7.2	8.0	8.8	W	Vop=220~230V
Rated Current	Ira	35	37	-	mA	Pd=8W
Operation Frequency	Fop	50 / 60			Hz	Vop=220~230V
Power Factor	PF	Over 0.95			V	Vop=220~230V
Current THD	ATHD	Less than 30%				Vop=220~230V
Percent Flicker	%	Less than 5%				Vop=220~230V
SVM		Less than 0.1				Vop=220~230V
Pst		Less than 0.4				Vop=220~230V

5. CIE Chromaticity Diagram

※ Correlated Color Temperature is derived from the CIE 1931 Chromaticity diagram.

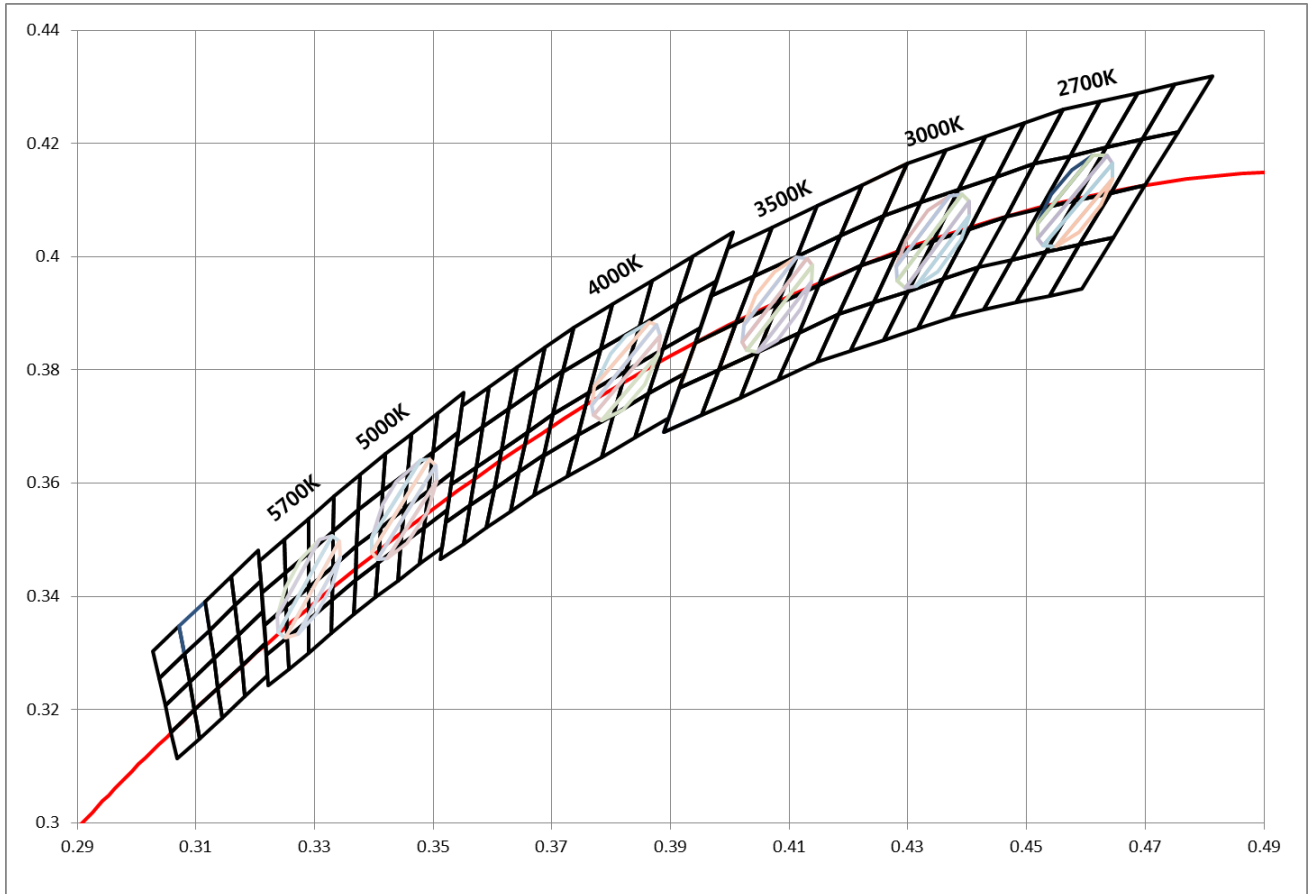

(1) Chromaticity coordinate groups are measured with an accuracy of ± 0.01

6. Chromaticity Coordinates

6-1. 2700K

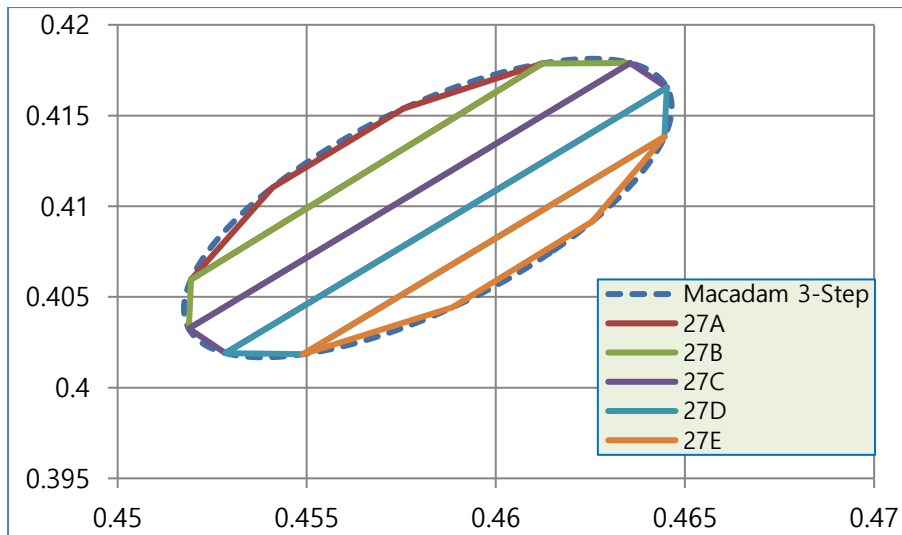

27A		27B		27C		27D		27E	
X	Y	X	Y	X	Y	X	Y	X	Y
0.4612	0.4179	0.4636	0.4179	0.4645	0.4165	0.4645	0.4138	0.4625	0.4092
0.4576	0.4154	0.4612	0.4179	0.4636	0.4179	0.4645	0.4165	0.4645	0.4138
0.4541	0.4110	0.4519	0.4060	0.4519	0.4033	0.4528	0.4019	0.4549	0.4018
0.4519	0.4060	0.4519	0.4033	0.4528	0.4019	0.4549	0.4018	0.4588	0.4044
0.4612	0.4179	0.4636	0.4179	0.4645	0.4165	0.4645	0.4138	0.4625	0.4092

6-2. 3000K

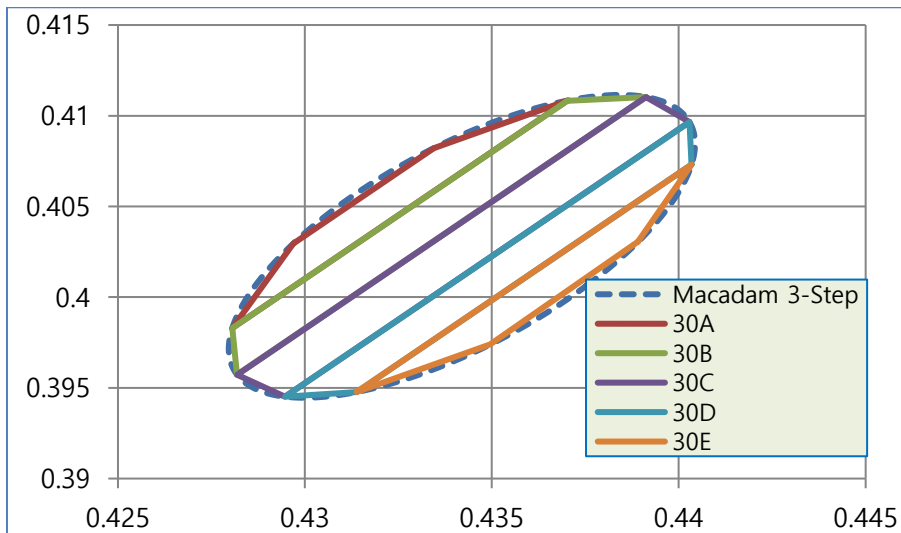

30A		30B		30C		30D		30E	
X	Y	X	Y	X	Y	X	Y	X	Y
0.4370	0.4108	0.4391	0.4110	0.4403	0.4097	0.4403	0.4073	0.4389	0.4031
0.4334	0.4082	0.4370	0.4108	0.4391	0.4110	0.4403	0.4097	0.4403	0.4073
0.4297	0.4030	0.4281	0.3983	0.4282	0.3957	0.4295	0.3945	0.4314	0.3948
0.4281	0.3983	0.4282	0.3957	0.4295	0.3945	0.4314	0.3948	0.4350	0.3974
0.4370	0.4108	0.4391	0.4110	0.4403	0.4097	0.4403	0.4073	0.4389	0.4031

6-3. 3500K

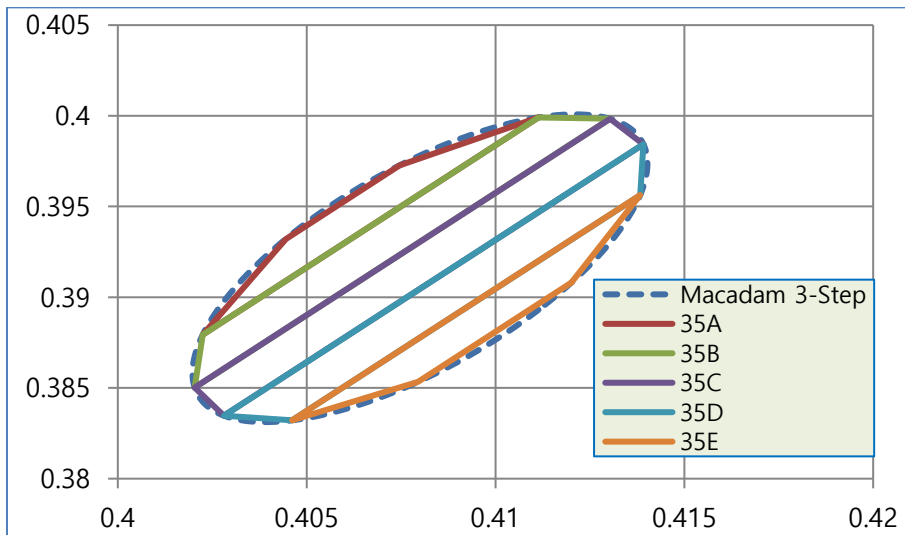

35A		35B		35C		35D		35E	
X	Y	X	Y	X	Y	X	Y	X	Y
0.4111	0.3999	0.4130	0.3998	0.4139	0.3984	0.4138	0.3956	0.4120	0.3908
0.4075	0.3973	0.4111	0.3999	0.4130	0.3998	0.4139	0.3984	0.4138	0.3956
0.4044	0.3932	0.4023	0.3879	0.4020	0.3850	0.4028	0.3835	0.4046	0.3832
0.4023	0.3879	0.4020	0.3850	0.4028	0.3835	0.4046	0.3832	0.4080	0.3853
0.4111	0.3999	0.4130	0.3998	0.4139	0.3984	0.4138	0.3956	0.4120	0.3908

6-4. 4000K

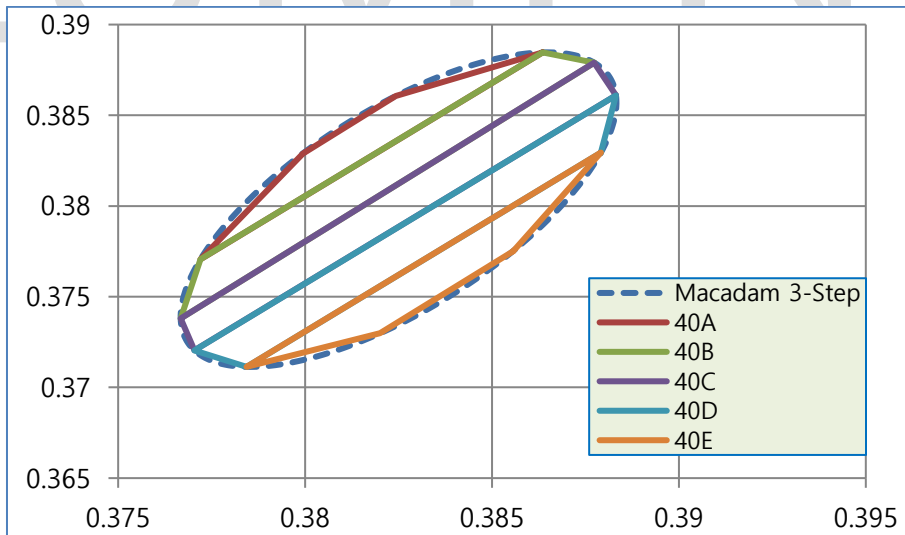

40A		40B		40C		40D		40E	
X	Y	X	Y	X	Y	X	Y	X	Y
0.3864	0.3885	0.3877	0.3879	0.3883	0.3861	0.3879	0.3829	0.3856	0.3775
0.3824	0.3861	0.3864	0.3885	0.3877	0.3879	0.3883	0.3861	0.3879	0.3829
0.3799	0.3829	0.3772	0.3771	0.3767	0.3738	0.3770	0.3720	0.3784	0.3711
0.3772	0.3771	0.3767	0.3738	0.3770	0.3720	0.3784	0.3711	0.3820	0.3730
0.3864	0.3885	0.3877	0.3879	0.3883	0.3861	0.3879	0.3829	0.3856	0.3775

6-5. 5000K

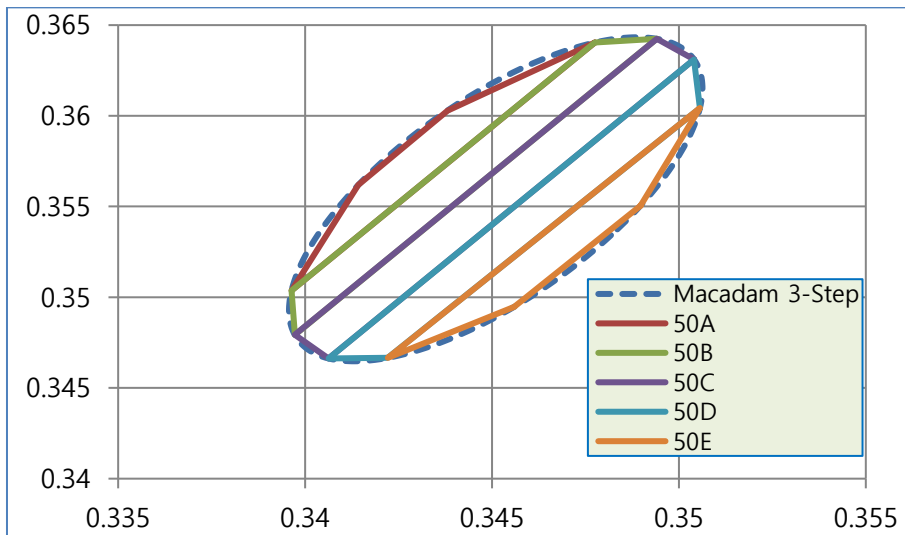

50A		50B		50C		50D		50E	
X	Y	X	Y	X	Y	X	Y	X	Y
0.3478	0.3640	0.3494	0.3642	0.3504	0.3631	0.3506	0.3604	0.3490	0.3550
0.3438	0.3603	0.3478	0.3640	0.3494	0.3642	0.3504	0.3631	0.3506	0.3604
0.3414	0.3562	0.3396	0.3504	0.3397	0.3479	0.3406	0.3466	0.3422	0.3467
0.3396	0.3504	0.3397	0.3479	0.3406	0.3466	0.3422	0.3467	0.3456	0.3495
0.3478	0.3640	0.3494	0.3642	0.3504	0.3631	0.3506	0.3604	0.3490	0.3550

6-6. 5700K

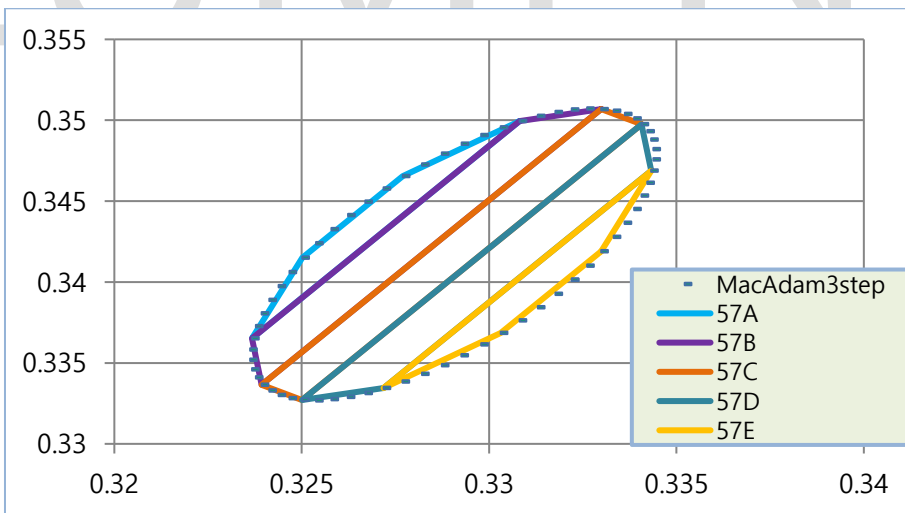

57A		57B		57C		57D		57E	
X	Y	X	Y	X	Y	X	Y	X	Y
0.3308	0.3500	0.3330	0.3507	0.3341	0.3497	0.3343	0.3469	0.3330	0.3419
0.3277	0.3465	0.3308	0.3500	0.3330	0.3507	0.3341	0.3497	0.3343	0.3469
0.3250	0.3415	0.3237	0.3365	0.3239	0.3337	0.3250	0.3327	0.3272	0.3334
0.3237	0.3365	0.3239	0.3337	0.3250	0.3327	0.3272	0.3334	0.3303	0.3369
0.3308	0.3500	0.3330	0.3507	0.3341	0.3497	0.3343	0.3469	0.3330	0.3419

7. Characteristic Graphs

7-1 Voltage Characteristics(Ta=25°C)

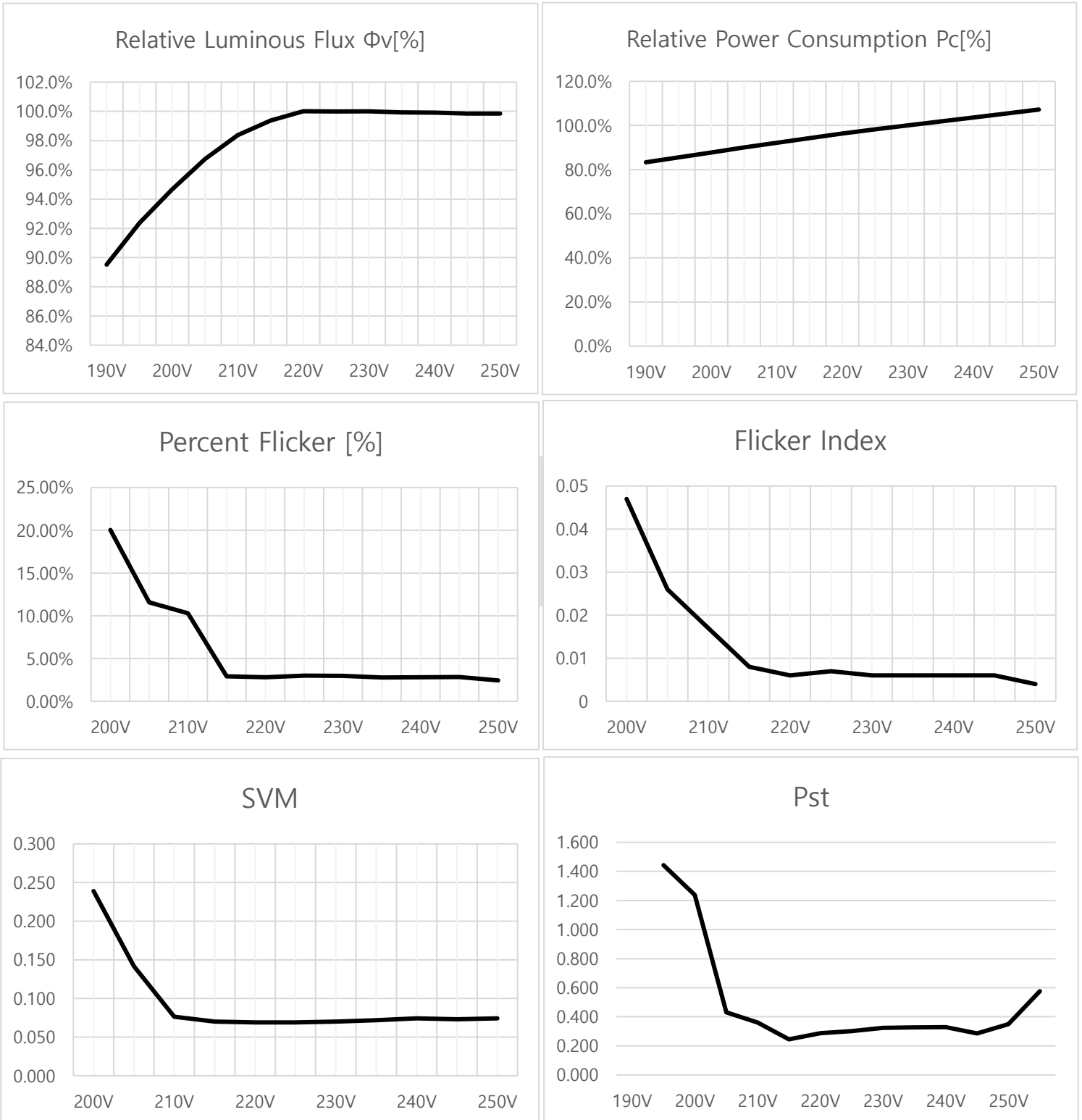

7-2 Spectrum Characteristics(Ta=25°C)

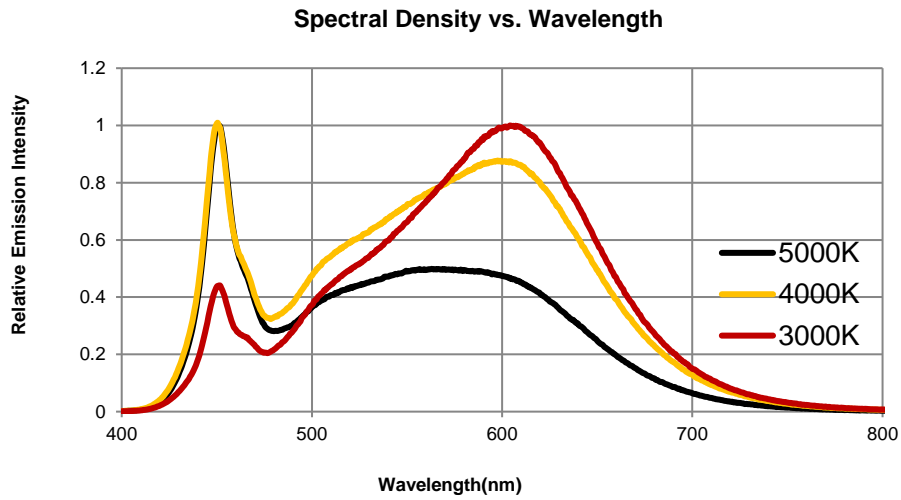

7-3 Temperature Characteristics

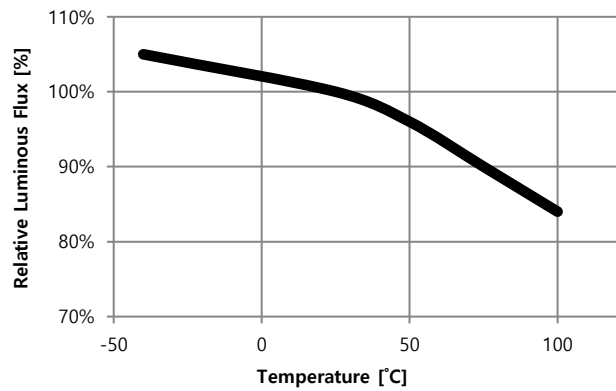
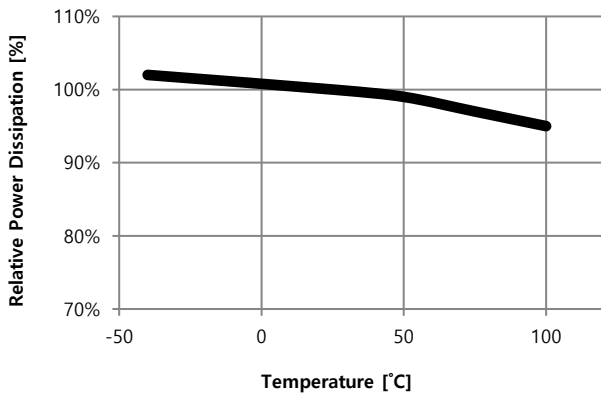

8. Outline Dimensions

8-1 PCB Dimensions

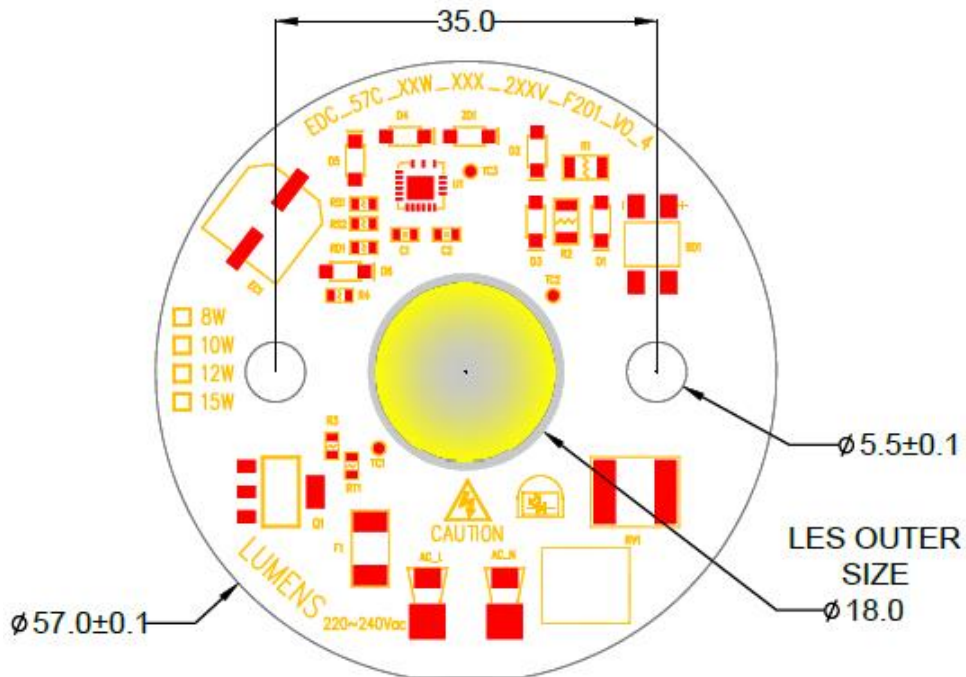

Unit : mm

- 1) Outline Diameter : 57ϕ , Height : 7.6mm (Include PCB)
- 2) Tolerance - All measurements are ± 0.2 mm unless otherwise indicated.

9. EDC Module Marking

- A. Information Identification by report on the PCB (Silk)
 - Module Identification Code
- B. LED Module Label

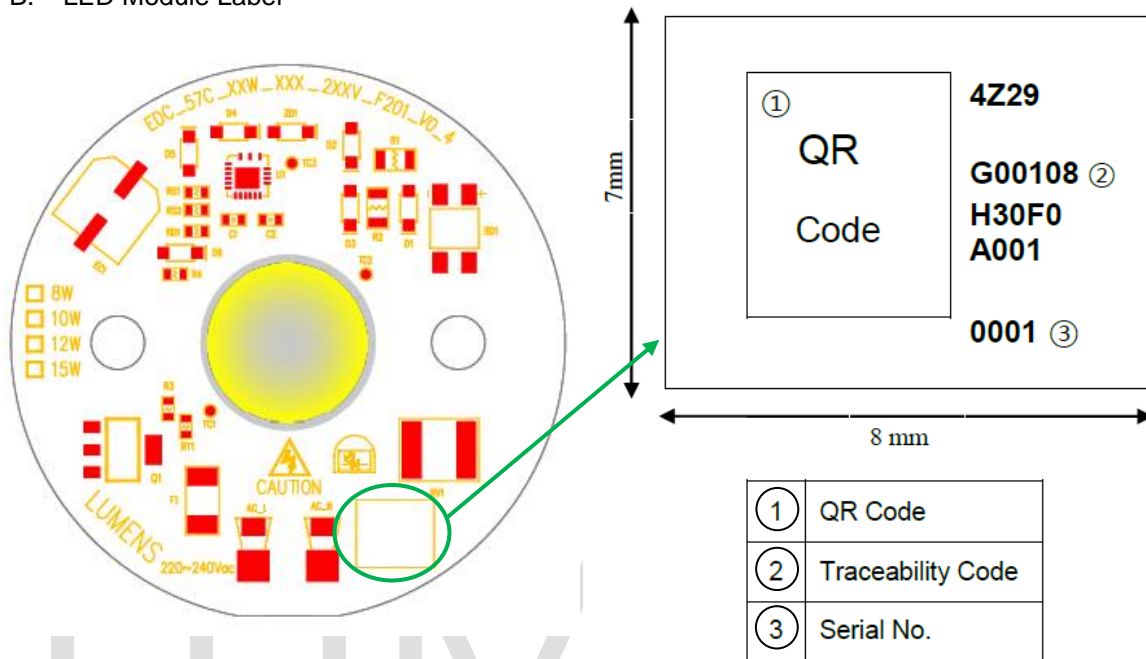

C-1 Traceability Code Table

No	1	2	3	4	5	6	7	8	9	10	11	12	13	14	15	16	17	18	19	20	21	22	23
Marking	4	8	1	5	T	9	9	9	1	8	H	3	0	C	0	A	0	0	1	0	0	0	1
Meaning	Manufacture Year/Month/Day				Manufacture Site	Group No.			Watt	CRI	CCT	Volt	Default	LOT Serial No.				Manufacture Serial No.					
Ciphers	4				1	3			2	1	2	1		4				4					
How to Use	1st : Last two digits of year 2nd : Month (1~9, X, Y, Z) 3th~4th : Day (01~31)				S : SIL/AN G : K2	999			18	H	30	C		A001				0001					

C-2 Traceability Code Marking Table

Manufacture Year/Month

code	Year
4	2014
5	2015
6	2016

Month	1	2	3	4	5	6	7	8	9
Code	1	2	3	4	5	6	7	8	9
Month	10	11	12						
Code	X	Y	Z						

Manufacture Day

Day	1	2	3	4	5	6	7	8	9	10	11
Code	01	02	03	04	05	06	07	08	09	10	11
Day	12	13	14	15	16	17	18	19	20	21	22
Code	12	13	14	15	16	17	18	19	20	21	22
Day	23	24	25	26	27	28	29	30	31		
Code	23	24	25	26	27	28	29	30	31		

Manufacture Site

Manufacture	K	G	H	S	T	B	Y	W	L
Code	K1	K2	K3	SILIAN	TSMT	-	-	-	-

Watt

Watt	1	2	3	4	5	6	7	8	9	10	...	99
Code	01	02	03	04	05	06	07	08	09	10	...	99
Watt	100	101	...	110	111	...	330	331	...	338	339	etc.
Code	A0	A1	...	B0	B1	...	Z0	Z1	...	Z8	Z9	ZZ

* AO:100, B0:110, C0:120, D0:130, E0:140, F0:150, G0:160, H0:170, J0:180, K0:190, L0:200, M0:210
 N0:220, P0:230, Q0:240, R0:250, S0:260, T0:270, U0:280, V0:290, W0:300, X0:310, Y0:320, Z0:330

CRI

CRI	Under 70	Min 70	Min 75	Min 80	Min 85	Min 90
Code	L	N	M	H	V	U

CCT

CCT	2700K	3000K	3500K	4000K	4500K	5000K	5700K	6500K
Code	27	30	35	40	45	50	57	65

Volt

Volt	100V	110V	120V	200V	220V	230V	240V	250V	277V	347V	DC	etc.
Code	A	B	C	D	E	F	G	H	J	K	X	Z

10. Package And Marking Of Product

A. Tray Information

Size : 200mm x 190mm x 16.5mm

Color : Clear

Surface Resistivity : $10^6 \sim 10^9 \Omega/\text{Sq.}$

B. Package

5 pcs are packed in one tray.

Packing TRAY : Stack Up 21 Layers

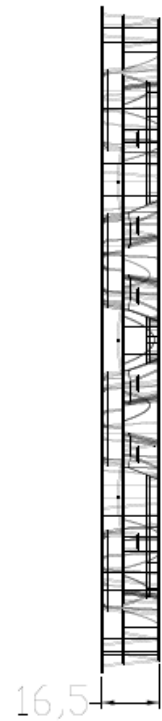
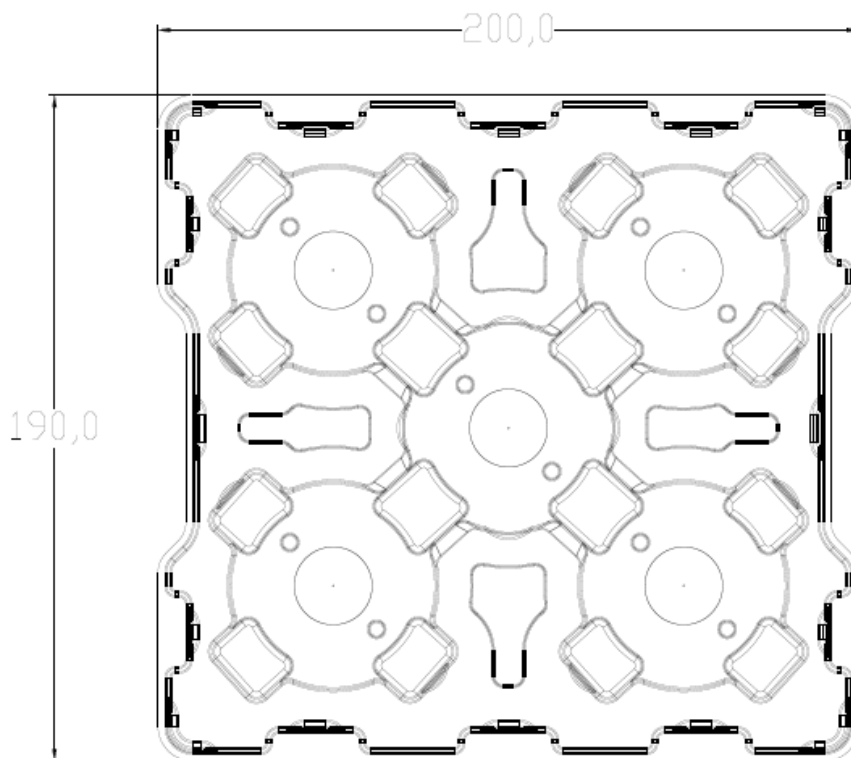

- Side view -

C. Box Packing Specifications

Tray products (numbers of products are 5 pcs) packed.

There is no product on the top tray

21 Tray (total maximum number of products are 100pcs) packed in a box.

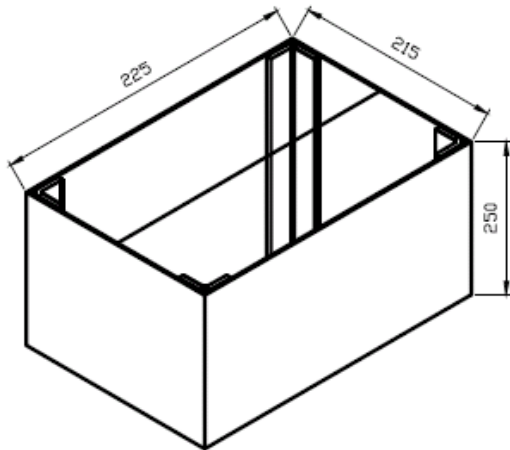

225 X 215 X 250 mm

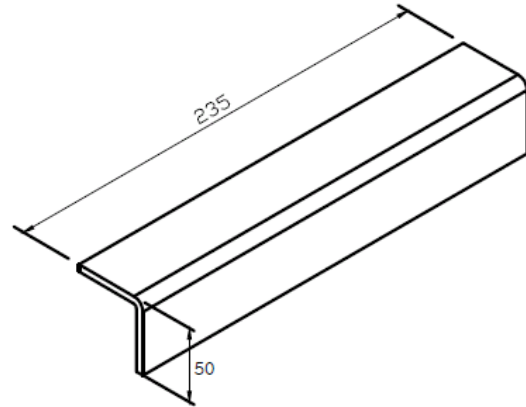

50 X 50 X 235 mm

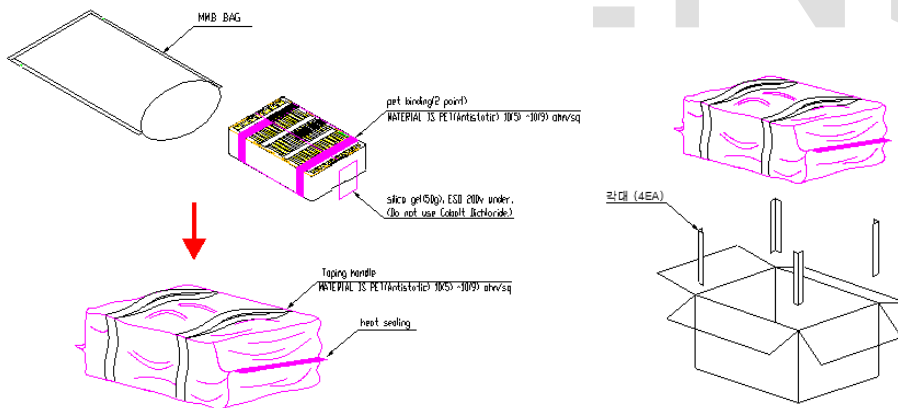

D. Pallet Loading

Box is stacked by 4 layers on the Pallet.

Each layer has 20 boxes

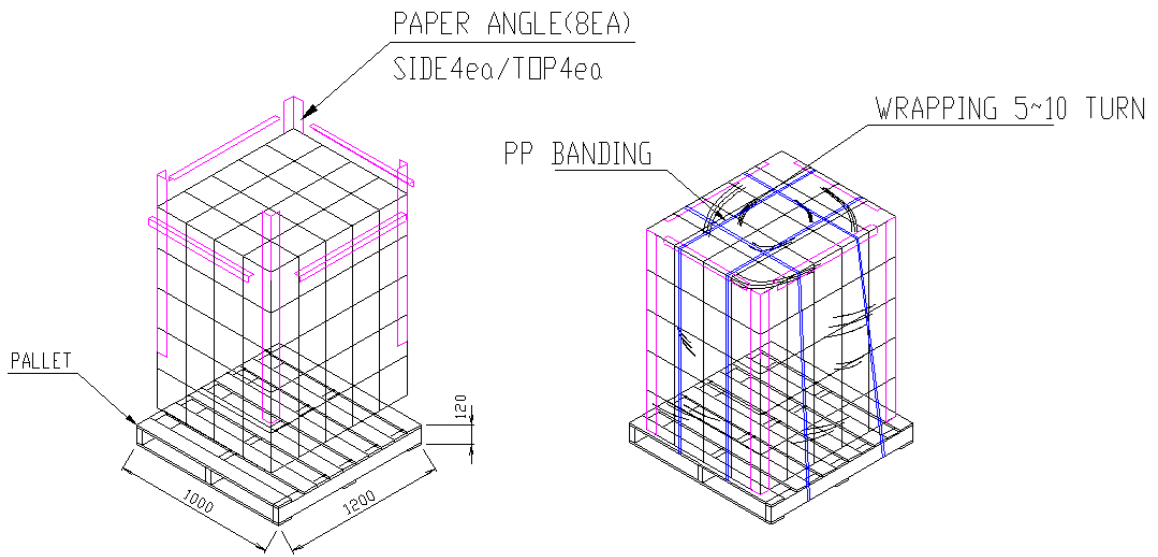

Size : 1,000mm(W) X 1,200mm(L) X 1,560mm(H)

LUMENS

E. BOX Label

Specifying Customer, Model, Customer Part No, Lot No, Quantity
 On both trays and boxes, the same label is attached.

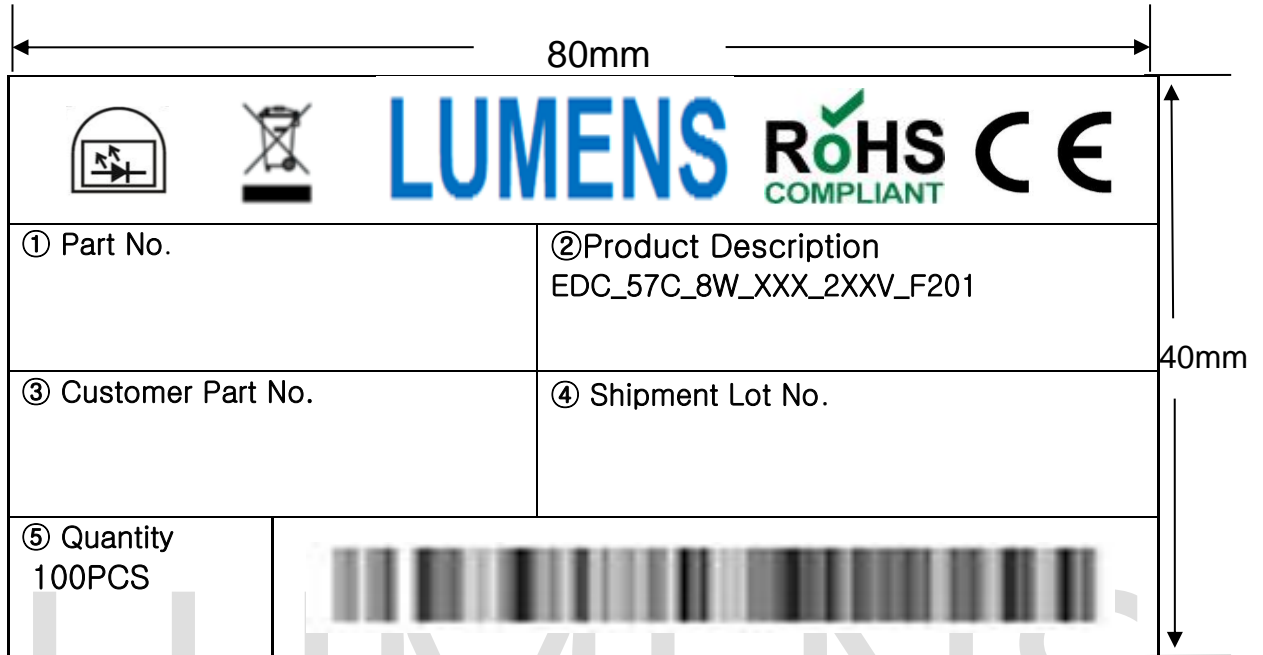

<Example>

- X : CRI (80CRI=8, 90CRI=9) ,
- XX : CCT (2700K=27, 3000K=30 , 3500K=35, 4000K=40, 5000K=50, 5700K=57)
- 2XXV : Input Voltage (220Vac=220V, 230Vac=230V)

1. PART No
2. Model Name.
3. Customer Part NO
4. Shipment Lot No.
5. Quantity.

F. Shipment Lot No. Indication

No	1	2	3	4	5	6	7	8	9	10	11	12	13	14	15
Marking	C	S	X	-	1	0	0	2	0	2	-	A	0	0	1
Meaning	COB	Manufacture Site	Default	Default	Packing Year/Month/Day						Default	Default	Packing Serial No.		
Ciphers	1	1			6								3		
How to Use	C : COB	G : K2 S : SILIAN	1st~2nd : Last two digits of year 3nd~4th : Month (01~12) 5th~6th : Day (01~31)						1						

11. Cautions

- ◆ The LED Module itself and all its components may not be mechanically stressed.
- ◆ Make sure proper discharge prior to starting work.
- ◆ DO NOT touch any of the circuit board, components or terminals with body or metal while circuit is active.
- ◆ Installation of LED Module needs to be made with regard to all applicable electrical and safety standards. Only qualified personnel should be allowed to perform installation.
- ◆ DO NOT add or change wires while circuit is active.
- ◆ DO NOT make any modification on module.
- ◆ DO NOT use adhesives to attach the LED that outgas organic vapor.
- ◆ DO NOT use together with the materials containing Sulfur.
- ◆ The LED Module needs to be mounted on a heat sink providing adequate thermal dissipation.
- ◆ DO NOT exceed the values given in this specification
- ◆ Be cautious when soldering to board so as not to create a short between different trace patterns.
- ◆ Keep cautions not to apply higher voltage above the maximum rating. Otherwise damage may occur.
- ◆ Pay attention not to exceed the maximum operation temperature of 85°C at the Tc1 Point when the modules are used in an enclosed environment.
(Tc1 Temperature Condition $\leq 85^{\circ}\text{C}$)
(Tc1 + 30°C \approx Maximum LES temperature(Tj)) : Depends on specification of heat sink
- ◆ DO NOT assemble in conditions of high moisture and/or oxidizing gas such as Cl, H₂S, NH₃, SO₂, NO_x, etc.
- ◆ The module should also not be installed in end equipment without ESD (Electrical Static Discharge) protection.
- ◆ Damage by corrosion will not be allowed as defect claim. Lumens LED Module is recommended for Indoor use only.
- ◆ Great care should be taken not to see directly the operated lighting LED. If not the intense light should cause the damage to eye. Use proper goggles to protect your eyes during operation.
- ◆ Long time exposure to sunlight or UV can cause the lens to discolor.
- ◆ Moisture-Proof package
 1. When moisture is absorbed into the LED light engine it may vaporize and expand products during manufacturing. There is a possibility that this may cause exfoliation of the contacts and damage to the optical characteristics of the LEDs. For this reason, the moisture-proof pack is used to keep moisture to a minimum in the package.
 2. A pack of a moisture-absorbent material (silica gel) is inserted into the shielding bag. The silica gel changes its color from blue to pink as it absorbs moisture.
- ◆ Storage Conditions
 1. Before opening the package: The LED light engines should be kept at 30°C or less and 90% RH or less. The LED light engines should be used within a year. When storing the LED light engines, moisture-proof packaging with moisture-absorbent material (silica gel) is recommended.
 2. After opening the package: The LED light engines should be kept at 30°C or less and 70% RH or less. The LEDs should be soldered within 168 hours (7 days) after opening the package. If unused LED light engines remain, they should be stored in moisture-proof packages, such as sealed containers with packages of moisture-absorbent material (silica gel). It is also recommended to return the LED light engines to the original moisture-proof bag and to reseal the moisture-proof bag again.
 3. Please avoid rapid transitions in ambient temperature, especially in high humidity environments where condensation can occur.
- ◆ Basic insulation is based on 230Vac.

ROHS
COMPLIANT



NOTE :

All the information published by Lumens is considered to be accurate and reliable. However Lumens does not warrant that product descriptions or other contents in this data sheet is accurate, complete, reliable, current, or error-free. Lumens disclaims any and all warranties and liabilities of an kind, including without limitation, warranties of non-infringement or implied warranty of merchantability of fitness for a particular purpose. The appearance and specifications of the product can be changed to improve quality, performance and/or design without advance notice. Lumens products are not authorized for use as critical components in life support devices or systems without the express written approval from the managing director of Lumens.